

SUMMARY of CHANGE

EM 385-1-1

Safety and Occupational Health Requirements

This major revision, dated 15 March 2024 —

- Changes the title from “Safety and Health Requirements Manual” to “Safety and Occupational Health Requirements”.
- Incorporates a new U.S. Corps of Engineers Safety and Occupational Health Management System (CE-SOHMS).
- Eliminates the term Government Designated Authority (GDA) within this manual.
- Streamlines document to reduce redundancies and eliminate unsubstantiated requirements.
- Adds new requirements for Site Safety and Health Officers.
- Adds requirements for fire prevention and protection associated with fire watches.
- Adds requirements for vehicles, machinery, and mechanized equipment associated with defensive driving.
- Adds requirements for loading handling equipment medical evaluation.
- Adds requirements for blasting associated with the Blaster-in-Charge and explosive site safety plan.
- Adds requirements for sanitation associated with food service training and extermination plan.
- Adds new requirements for uncrewed aircraft.
- Incorporates requirements for the Army Electrical and Hazardous Energy Control (HEC) Safety Program.

CESO

Manual
No. 385-1-1

15 March 2024

Safety
SAFETY AND OCCUPATIONAL HEALTH (SOH) REQUIREMENTS

1. Purpose. This Engineering Manual establishes workplace standards to ensure that employees are protected from hazards that compromise their occupational safety and occupational health.

2. Applicability. This manual applies to Headquarters, US Army Corps of Engineers (HQUSACE) elements, major subordinate commands, districts, centers, laboratories, and field operating activities (FOA), as well as USACE contracts and those administered on behalf of USACE. Applicability extends to occupational exposure for missions under the command of the Chief of Engineers, whether accomplished by military, civilian, direct contractors, or contractor personnel performing activities at a USACE site of work.

3. Distribution Statement. Approved for public release; distribution is unlimited.

4. References.

Note. In addition to paragraphs a-h below, each chapter will feature its own dedicated reference list.

a. AR 40-5, Army Public Health Program
(<https://armypubs.army.mil/ProductMaps/PubForm/AR.aspx>)

b. AR 385-10, Army Safety Program
(<https://armypubs.army.mil/ProductMaps/PubForm/AR.aspx>)

c. DoDI 6055.1, DOD Safety and Occupational Health Program
(<https://www.esd.whs.mil/Directives/issuances/dodi/>)

d. ES 16009, Corps of Engineers Safety and Occupational Health Management System (<https://team.usace.army.mil/sites/HQ/SO/Pages/CESOHMS.aspx>)

e. Executive Order 12196, Occupational Safety and Health Programs for Federal Employees, 26 Feb 1980 (<https://www.archives.gov/federal-register/codification/executive-order/12196.html>)

*This manual supersedes EM 385-1-1, dated 30 November 2014.

f. Federal Acquisition Regulation (FAR) Clause 52.236-13, Accident Prevention (<https://www.govinfo.gov/content/pkg/CFR-2020-title48-vol2/pdf/CFR-2020-title48-vol2-chap1-subchapH.pdf>)

g. 29 CFR 1910, Occupational Safety and Health Standards for General Industry (<https://www.govinfo.gov/app/collection/cfr>)

h. 29 CFR 1926, Occupational Safety and Health Standards for Construction (<https://www.govinfo.gov/app/collection/cfr>)

i. 29 CFR 1960, Basic Program Elements for Federal Employees, OSHA (<https://www.govinfo.gov/content/pkg/CFR-2020-title29-vol9/pdf/CFR-2020-title29-vol9-part1960.pdf>)

5. General.

a. The implementation of this manual is designed to supplement the Safety and Occupational Health requirements as prescribed in paragraph 4 of this preamble. In addition to complying with the requirements included in this manual, follow all applicable federal, host nation, state, and local laws, ordinances, criteria, rules, and regulations. Where the requirements of this manual, applicable laws, criteria, ordinances, regulations vary, the most stringent requirements govern. Deviations from USACE publications require waiver approval from the applicable HQUSACE proponent (see chapters 1 and 2).

b. Mission applicability introduced in paragraph 2 above must include the following:

(1) Construction contract work under the provisions of FAR Clause 52.236-13. Contractors must comply with the latest version of this manual (including interim changes) that is in effect on the date of solicitation. Prior to making an offer, bidders should check the HQUSACE Safety and Occupational Health website (see paragraph c) for the latest changes. No separate payment will be made for compliance with this paragraph or for compliance with other safety and health requirements of this contract.

Note. Existing contracts will continue to apply the provisions of the previous edition of this manual until contract completion.

(2) Maintenance, service, research/development, and supply must comply with this manual. Compliance with this manual will be a contract requirement for all activities unless technical representatives (in coordination with local Safety and Occupational Health Office) advise that special precautions are not appropriate due to extremely limited scope of services or similar.

(3) Contracting actions for hazardous, toxic, and radioactive waste site investigation, design, or remediation activities. Compliance with this manual will be a contract requirement.

c. Changes.

(1) All interim and permanent changes made to this manual after its publication date will be posted on the official publications HQ USACE website: <https://www.publications.usace.army.mil/>.

(2) The use of underlining in this manual indicates new or changed text from the EM 385-1-1 2014 edition.

d. Citation Instructions. This manual uses citations to allow the user to quickly navigate each chapter and paragraphs. The citations start with the chapter number, then paragraph number, followed by a letter corresponding to the subparagraph. For example, 10-3.b means chapter 10, paragraph 3, first subparagraph b.

e. Activities performed outside the continental United States (OCONUS). Some of the technical requirements of this manual may not be applicable to overseas activities due to conflicting circumstances, practices, and laws or regulations of the locality or the unavailability of equipment. In such instances, means other than the ones specified in this manual may be used to achieve the required protection. In such instances, a hazard analysis must be developed to document that the required protection will be achieved by the alternate means.

f. Unless otherwise indicated, when publications are referenced in this manual, the most recent edition is to be used.

g. Interpretations, Variance, and Waivers can only be authorized by the Chief of Safety and Occupational Health, HQUSACE. Refer to chapters 1 and 2 for applicable processes.

h. Supplementations can only be authorized by the Chief of Safety and Occupational Health, HQUSACE.

(1) Local USACE organizations may develop Standard Operating Procedures (SOPs) to implement the provisions contained within this manual, but may not implement new requirements (for example, more stringent, differing intent, etc.) without the specific approval of HQUSACE.

(2) Locally developed Safety and Health Requirements will not be included in contract requirements without the approval of HQUSACE.

i. USACE has transitioned to a performance-based safety management system known as CE-SOHMS (Corps of Engineers Safety and Occupational Health

Management System). CE-SOHMS enhances the agency's safety culture based on employee involvement at every level of the organization, while also providing for continued process improvement. USACE contractors are highly encouraged to implement a safety management system of their own but is not mandatory. Refer to ES 16009 for current USACE guidance.

6. Records Management (recordkeeping) requirements. The records management requirement for all record numbers, associated forms, and reports required by this regulation are addressed in the Army Records Retention Schedule – Army (RRS-A). Detailed information for all related record numbers is located in the Army Records Information Management System (ARIMS)/RRS-A at <https://www.arims.army.mil>. If any record numbers, forms, and reports are not current, addressed, and/or published correctly in ARIMS/RRS-A, see Department of the Army (DA) Pamphlet 25-403, Guide to Recordkeeping in the Army, for guidance.

FOR THE COMMANDER:



JAMES J. HANDURA
COL, EN
Chief of Staff

Contents (Listed by chapter and page number)

Preamble

Chapter 1

Safety and Occupational Health Program Management for United States Army Corps of Engineers Personnel, *page 10*

Chapter 2

Safety and Occupational Health Program Management for Contractors, *page 36*

Chapter 3

Medical and First Aid, *page 61*

Chapter 4

Temporary Facilities, *page 72*

Chapter 5

Personal Protective and Lifesaving Equipment, *page 77*

Chapter 6

Hazardous or Toxic Agents and Environments, *page 120*

Chapter 7

Lighting, *page 152*

Chapter 8

Accident Prevention Signs, Tags, Labels, Signals, and Traffic Control, *page 156*

Chapter 9

Fire Prevention and Protection, *page 163*

Chapter 10

Welding and Cutting, *page 186*

Chapter 11

Electrical, *page 199*

Chapter 12

Control of Hazardous Energy, *page 249*

Chapter 13

Hand and Power Tools, *page 266*

Contents-Continued

Chapter 14

Material Handling, Storage, Disposal, and Conveyors, *page 276*

Chapter 15

Rigging, *page 302*

Chapter 16

Load Handling Equipment, *page 310*

Chapter 17

Demolition, Renovation, and Re-Occupancy, *page 366*

Chapter 18

Vehicles, Machinery, and Mechanized Equipment, *page 376*

Chapter 19

Floating Plant and Marine Activities, *page 404*

Chapter 20

Pressurized Equipment and Systems, *page 437*

Chapter 21

Fall Protection, *page 449*

Chapter 22

Working Platforms and Scaffolding, *page 484*

Chapter 23

Rope Access, *page 527*

Chapter 24

Safe Access, *page 534*

Chapter 25

Excavation and Trenching, *page 546*

Chapter 26

Underground Construction, Shafts, and Caissons, *page 563*

Chapter 27

Concrete, Masonry, Roofing, and Wood Construction, *page 581*

Contents-Continued

Chapter 28

Steel Erection, *page 594*

Chapter 29

Blasting, *page 614*

Chapter 30

Diving Operations, *page 636*

Chapter 31

Tree Maintenance and Removal, *page 669*

Chapter 32

Airfield and Aircraft Operations, *page 683*

Chapter 33

Uncrewed Aircraft, *page 688*

Chapter 34

Confined Space, *page 697*

Chapter 35

Sanitation, *page 714*

Chapter 36

Hazardous Waste Operations and Emergency Response, *page 726*

Chapter 37

Emergency Operations, *page 741*

Table List

Table 1–1: USACE Risk Acceptance Matrix, *page 35*

Table 2–1: Accident Reporting Required Timeline, *page 61*

Table 3–1: Requirements for Basic First Aid Unit Package, *page 71*

Table 5–1: Eye and Face Protector Section Guide, *page 106*

Table 5–2: Required Shades for Filter Lenses/Glasses in Welding Cutting, Brazing, and Soldering, *page 113*

Table 5–3: Settings for Noise Measuring Equipment, *page 114*

Table 5–4: Continuous Noise Exposures (ACGIH TLV), *page 115*

Table 5–5: Hand and Arm Protection, *page 115*

Table 5–6: Hand and Arm Protection Cut Resistance Levels, *page 117*

Table 5–7: Standards for Electrical Personal Protective Equipment, *page 117*

Table 5–8: Arc Flash Personal Protective Equipment, *page 118*

Contents-Continued

- Table 6–1: Abrasive Blasting Media, Silica Substitutes, *page 151*
- Table 7–1: Minimum Lighting Requirements, *page 154*
- Table 9–1: Temporary Heating Device Clearances, *page 184*
- Table 9–2: Fire Extinguisher Distribution, *page 185*
- Table 11–1: Limited Approach Boundaries to Exposed Energized Electrical Conductors or Circuit Parts (Alternating-Current Systems), *page 245*
- Table 11–2: Limited Approach Boundaries to Exposed Energized Electrical Conductors or Circuit Parts (Direct-Current Systems), *page 247*
- Table 11–3: Qualified Person Minimum Approach Distances, *page 248*
- Table 11–4: Mechanical Equipment and Unqualified Persons Minimum Approach Distances from Overhead Lines and Equipment, *page 249*
- Table 14–1: Maximum Allowable Size of Portable Container and Tanks for Flammable Liquids, *page 301*
- Table 14–2: Outside Storage of LP-Gas Containers and Cylinders – Minimum Distances, *page 302*
- Table 16–1: Minimum Clearance from Energized Overhead Electric Lines, *page 365*
- Table 16–2: Minimum Clearance Distance from Energized Overhead Electric Lines While Traveling with No Load, *page 365*
- Table 19–1: Fire Extinguisher Requirements for Launches/Motorboats, *page 437*
- Table 22–1: Form Scaffolds – Minimum Design Criteria for Wooden Bracket Form Scaffolds, *page 526*
- Table 22-2: Form Scaffolds – Minimum Design Criteria for Light-Duty Figure-Four Form Scaffolds, *page 526*
- Table 22–3: Minimum Dimensions for Horse Scaffold Members, *page 526*
- Table 25–1: Soil Classification, *page 562*
- Table 25–2: Maximum Allowable Slopes by Soil Type, *page 563*
- Table 28–1: Erection Bridging for Short Span Joists, *page 612*
- Table 28–2: Erection Bridging for Long Span Joists, *page 613*
- Table 30–1: Umbilical Markings, *page 665*
- Table 30–2: Staffing Levels for SCUBA: Untethered, 0 to 100 feet, *page 666*
- Table 30–3: Staffing Levels for SCUBA: Tethered with Communications, 0 to 100 feet, *page 666*
- Table 30–4: Staffing Levels for Surface Supplied Air: 0 to 100 feet within No Decompression Limits, *page 666*
- Table 30–5: Staffing Levels for Surface Supplied Air: 0 to 100 feet Requiring Decompression and All Surface Supplied Air: 101 to 190 feet, *page 667*
- Table 30–6: Staffing Levels for Surface Supplied Mixed-Gas Diving, *page 667*
- Table 30–7: Staffing Levels for Scientific Snorkeling: Untethered, 0 to 5 feet, *page 668*
- Table 30–8: Staffing Levels for Scientific Snorkeling: Tethered, Greater than 5 feet, *page 668*
- Table 35–1: Minimum Toilet Facilities (Other than Construction Sites), *page 725*
- Table 35–2: Minimum Toilet Facilities (Construction Sites), *page 725*

Contents-Continued

Figure List

- Figure 5–1: Personal Floatation Devices, *page 105*
- Figure 12–1: Application of Relevant Standards to Site-Specific Energy Control Plan, *page 264*
- Figure 12–2: Hazard Isolation Procedure Example, *page 265*
- Figure 15–1: Wire Rope Clip Spacing, *page 309*
- Figure 15–2: Wire Rope Clip Orientation, *page 310*
- Figure 19–1: Railing Type A, Two Tier Rigid Fall Protection Railing, *page 434*
- Figure 19–2: Marine Railing Type B, *page 435*
- Figure 19–3: Marine Railing Type C, *page 436*
- Figure 21–1: Calculating Distance, *page 483*
- Figure 21–2: Designated Area, *page 484*
- Figure 25–1: Allowable Sloping Configuration for Type A, Type B, and Type C Soils, *page 561*
- Figure 25–2: Allowable Benching and Sloping for Type A and Type B Soils, *page 561*
- Figure 25–3: Excavations with Vertically Sided Lower Portions, *page 562*
- Figure 28–1: Clip End Connection, *page 609*
- Figure 28–2: Staggered (High/Low Connection), *page 609*
- Figure 28–3: Controlling Risk for Double Connections in Steel Erection (Side View), *page 610*
- Figure 28–4: Double Connection with Seat to Support First Section While Second Section is Being Installed, *page 610*
- Figure 28–5: Illustrations of OSHA Bridging Terminus Points, *page 611*
- Figure 37–1: Blue-Roof Mission Fall Protection Chart, *page 756*

Chapter 1

Safety and Occupational Health Program Management for United States Army Corps of Engineers Personnel

This chapter applies to all U.S. Army Corps of Engineers (USACE) elements, major subordinate commands, districts, centers, laboratories, and field operating activities. This chapter provides the overall programmatic guidance for developing, managing, and implementing a Safety and Occupational Health (SOH) program. The requirements set forth in this chapter are the foundation for the USACE SOH program and must be carried through the additional chapters in this manual.

Note. The term Government Designated Authority (GDA) is no longer applicable within this manual. GDA has been replaced with the responsibility of the USACE supervisor.

1-1. References.

- a. ANSI/ ASSP A10.33 Safety and Health Program Requirements for Multi-Employer Projects (<https://webstore.ansi.org/>) (1-1.a)
- b. ANSI/ASSP Z490.1, Criteria for Accepted Practices in Safety, Health and Environmental Training (<https://webstore.ansi.org/>) (1-1.b)
- c. AR 40-5, Army Public Health Program (<https://armypubs.army.mil/ProductMaps/PubForm/AR.aspx>) (1-1.c)
- d. AR 385-10, The Army Safety and Occupational Health Program (<https://armypubs.army.mil/ProductMaps/PubForm/AR.aspx>) (1-1.d)
- e. DA Pam 385-10, Army Safety Program and Occupational Health Program Procedures (<https://armypubs.army.mil/ProductMaps/PubForm/PAM.aspx>) (1-1.e)
- f. DA Pam 385-40, Army Mishap Investigations and Reporting (<https://armypubs.army.mil/ProductMaps/PubForm/PAM.aspx>) (1-1.f)
- g. DoDI 6055.1, DoD Safety and Occupational Health Program (<https://www.esd.whs.mil/Directives/issuances/dodi>) (1-1.g)
- h. DoDI 6055.07, Mishap Notification, Investigation, Reporting, and Record Keeping (<https://www.esd.whs.mil/Directives/issuances/dodi>) (1-1.h)
- i. DoDI 6055.12, Hearing Conservation Program (<https://www.esd.whs.mil/directives/issuances/dodi/>) (1-1.i)
- j. Executive Order 12196, Occupational Safety and Health Programs for Federal Employees, February 26, 1980 (<https://www.archives.gov/federal-register/codification/executive-order/12196.html>) (1-1.j)

- k. EM 5-1-11, Management Project Deliver Business Process (<https://www.publications.usace.army.mil/Portals/76/Users/182/86/2486/EM%205-1-11.pdf?ver=0OD9KZCW2k2Q7AIN8MX57A%3d%3d>) (1-1.k)
- l. EP 385-1-99, Implementation of Accident Investigation and Reporting (<https://www.publications.usace.army.mil/USACE-Publications/Engineer-Pamphlets/>) (1-1.l)
- m. ER 385-1-99, USACE Accident Investigation and Reporting (<https://www.publications.usace.army.mil/USACE-Publications/Engineer-Regulations/>) (1-1.m)
- n. ES 16009, Corps of Engineers Safety and Occupational Health Management System (<https://team.usace.army.mil/sites/HQ/SO/Pages/CESOHMS.aspx>) (1-1.n)
- o. 5 CFR 293, Personnel Records (<https://www.govinfo.gov/content/pkg/CFR-2020-title5-vol1/pdf/CFR-2020-title5-vol1-part293.pdf>) (1-1.o)
- p. 29 CFR 1904, Recording and Reporting Occupational Injuries and Illnesses (<https://www.govinfo.gov/content/pkg/CFR-2020-title29-vol5/pdf/CFR-2020-title29-vol5-part1904.pdf>) (1-1.p)
- q. 29 CFR 1910, Occupational Safety and Health Standards (<https://www.govinfo.gov/app/collection/cfr>) (1-1.q)
- r. 29 CFR 1926, Safety and Health Regulations for Construction (<https://www.govinfo.gov/app/collection/cfr>) (1-1.r)
- s. 29 CFR 1960, Basic Program Elements for Federal Employee Occupational Safety and Health Programs and Related Matters (<https://www.govinfo.gov/content/pkg/CFR-2020-title29-vol9/pdf/CFR-2020-title29-vol9-part1960.pdf>) (1-1.s)
- t. 46 CFR Subpart 4.05, Notice of Marine Casualty and Voyage Records (<https://www.govinfo.gov/content/pkg/CFR-2020-title46-vol1/pdf/CFR-2020-title46-vol1-part4-subpart4-05.pdf>) (1-1.t)
- u. 49 CFR 197.484, Notice of Casualty (<https://www.govinfo.gov/content/pkg/CFR-2002-title46-vol7/pdf/CFR-2002-title46-vol7-sec197-484.pdf>) (1-1.u)

1-2. Definitions.

- a. Accident. Any unplanned event or series of events that results in death, injury, or illness to personnel, or damage to or loss of equipment or property. Within the context of this manual, accident is synonymous with mishap. (1-2.a)

b. Collateral Duty Safety Officer (CDSO). A designated USACE employee who is trained to assist with the SOH program as a minor duty (that is, 20% or less of the time). (1-2.b)

c. Competent Person (CP). One who is capable of identifying existing and predictable hazards in the surroundings or working conditions which are unsanitary, hazardous, or dangerous to employees, and who has authorization to take prompt corrective measures to eliminate them. (1-2.c)

d. Contractor. Any individual or firm under contractual agreement with the government or its subunits for the performance of services and products, such as construction, maintenance, and hazardous waste activities, including all subcontractors. (1-2.d)

e. Employee. A government person engaged in work for USACE (including military, interns, students, etc.). (1-2.e)

f. Facility. A permanent or temporary location that includes the following: building, structure, shed, tower, utility support system or utility conveyance system, swimming pool or other open concrete structure, whether above or below grade, or any other item that is designated by the supervisor as a facility. (1-2.f)

g. Hazard. Any actual or potential condition that can cause injury, illness, or death of personnel, damage to or loss of equipment or property, or contribute to mission degradation. (1-2.g)

h. Imminent Danger. Any conditions or practices in a place of employment which are such that a danger exists which could reasonably be expected to cause death or serious physical harm immediately or before the imminence of such danger can be eliminated. (1-2.h)

i. Mishap. Within the context of this manual, mishap is synonymous with accident. See definition for accident in paragraph 1-2.a. (1-2.i)

j. Near Miss. A potentially serious accident that could have resulted in personal injury, death, or property damage, damage to the environment, or illness but did not occur due to one or more factors. (1-2.j)

k. Project Manager (PM). An individual assigned to achieve the project objectives. The PM manages the scope, schedule, budget, and quality while leading a project delivery team (PDT). PMs may be assigned to any organizational or geographic element. (1-2.k)

l. Qualified Person (QP). An individual who, by possession of a recognized degree, certificate, or professional standing, or who by extensive knowledge, training,

and experience, has successfully demonstrated the ability to solve or resolve problems relating to the subject matter, the work, or the project. (1-2.l)

m. Quality Assurance Representative (QAR). A Government employee (for example, construction representative) that assures end product quality, by monitoring the contractor's quality control (QC) activities and performing independent testing and/or inspections of contract work. (1-2.m)

n. Registered Professional Engineer (RPE). A person who has been duly and currently registered and who is licensed as a professional engineer by an authority (for example, state licensure board) within the United States or its territories to practice the profession of engineering. (1-2.n)

o. Residual Risk. The level of risk remaining after controls have been identified and countermeasures selected for hazards. Risks remaining after hazard mitigation measures have been applied. (1-2.o)

p. Risk Assessment Code (RAC). The conversion of the probability and severity of a given hazard into a specific risk level based on the residual risk. The levels of risk are extremely high (E), high (H), medium (M) and low (L). (1-2.p)

q. Risk Management. A business process that includes the identification, assessment, and prioritization of risks, followed by coordinated and economical application of resources to minimize, monitor, and control the probability and/or impact of unfortunate events to an acceptable level. (1-2.q)

r. Risk Matrix. A risk management tool that is used to determine the RAC for a specific work element and the overall RAC for the activity, task, or definable feature of work (DFOW). The risk matrix is used to evaluate the severity (that is, an approximate amount of potential harm, damage, or injury occurring) and probability (that is, likelihood of something happening) associated with a given accident, see paragraph 1-10.b. Severity is categorized as catastrophic, critical, moderate, or negligible. Probability is categorized as frequent, likely, occasional, seldom, or unlikely. (1-2.r)

s. Visitor. Anyone who is not assigned to work at the work site, either permanently or temporarily, that comes to the work site for short-term action (for example, inspections, meetings, deliveries). (1-2.s)

1-3. Personnel Required Qualification/Training.

a. General Employee-Required Qualifications and Training. The requirements in this paragraph apply to all trainings and qualifications outlined in this manual. See paragraph 3 of each chapter for applicable training and qualification requirements. (1-3.a)

(1) Supervisor must provide their employees all required SOH training as required by this manual, applicable federal, state, and local requirements.

(2) All SOH training must be conducted by QP or CP as required.

(3) Develop and deliver training according to ANSI Z490.1.

(4) Evaluate trainees to ensure they meet and understand the proposed objective(s).

(5) Document all training. Records must include the following:

(a) The date, location, and duration of the training.

(b) Name and description of the training.

(c) Name(s) of trainer(s).

(d) Training materials used.

(e) Name(s) of training participants.

(f) Evaluation of trainees to ensure they meet and understand the proposed objective(s). Document evaluation result of each participant (for example, pass, fail).

(6) Indoctrination Training. Provide and document employees and volunteers SOH indoctrination training based on the applicable SOH program, and federal, state, and local requirements prior to the start of work. The training must include the following:

(a) Corps of Engineers Safety and Occupational Health Management System (CE-SOHMS) awareness training.

(b) Requirements and responsibilities for accident prevention and the maintenance of safe and healthful work environments.

(c) General SOH policies and procedures and pertinent provisions of this manual.

(d) Employee and supervisor responsibilities for reporting all accidents and near misses.

(e) Provisions for medical facilities and emergency response and procedures for obtaining medical treatment or emergency assistance.

(f) Procedures for reporting and correcting hazards, unsafe conditions or practices.

(g) Job hazards and the means to control and eliminate those hazards, including applicable Position Hazard Analysis (PHA) and Activity Hazard Analysis (AHA) (see paras 1-6 and 1-8.c).

(7) Employees and volunteers that work around water must be provided basic water safety training to include the following:

(a) The “Reach, Throw, Row, Don’t Go” method.

(a-1) Reach. Hold on to the dock or your boat and reach your hand, a boat oar, a fishing pole, or whatever you have nearby, to the person.

(a-2) Throw. If you cannot reach far enough, toss things that float for the person to grab.

(a-3) Row. If you are in a boat, use the oars to move the boat closer to the person in the water, or call out to a nearby boat for help. Do not operate the boat’s motor close to a person in the water, they could be injured by the propeller.

(a-4) Don’t Go. Do not go into the water unless you are trained. Call out for help.

(b) Hazards associated with working around water (for example, temperature, depth, current).

(c) Hands-on training on how to use rescue equipment (for example, throw rings and bags) and personal protective equipment (PPE) (for example, personal flotation devices(PFD)) properly.

b. Collateral Duty Safety Officer (CDSO). CDSOs will be designated in writing on ENG Form 6283 (Collateral Duty Safety Officer Designation Letter) (see para 1-10.c) or equivalent and will have: (1-3.b)

(1) Initial SOH Training.

(a) All CDSOs must receive Occupational Safety and Health Administration (OSHA) or Proponent-Sponsored Engineer Corps Training (PROSPECT) 30-hour general industry or construction safety training. OSHA 6005- Collateral Duty Course for Other Federal Agencies is also permitted. Training may be web-based if permitted by OSHA. In lieu of formal OSHA 30-hour or PROSPECT 30-hour, SOH training covering the subjects of the 30-hour course and this manual may be accepted by the local Safety and Occupational Health Office (SOHO). The local SOHO will evaluate the proposed equivalent training for applicability to the work being performed.

(b) CDSOs must receive training according to 29 CFR 1960.58. The local SOHO will determine the content and length of training required.

(2) Competency Training Requirements. After appointment, CDSOs must maintain competency by taking 24 hours of documented formal classroom or online SOH-related training every three years. The 24 hours can be multiple classes combined.

(3) Experience Requirements. CDSOs must have a minimum of three years of experience and have knowledge of the work being performed to identify hazards and implement controls.

Note. Supervisor, in coordination with the SOHO, may adjust the training and experience requirements.

c. Quality Assurance Representative (QAR). All QARs (for example, Construction Representative, Quality Assurance Officers, etc.) should receive OSHA or PROSPECT 30-hour general industry or construction safety training. Training may be web-based training if permitted by OSHA. In addition, the local SOHO or their designated appointee must provide SOH awareness training commensurate with the hazards they may encounter during the performance of their duties. (1-3.c)

d. Supervisors. All USACE supervisors must receive SOH training within 12 months of hire to enable them to recognize and control safety and health hazards in their working units and manage the USACE SOH program. Refresher training will be provided every three years. Training must include the following: (1-3.d)

(1) Supervisory responsibility for providing and maintaining safe and healthful working conditions for employees.

(2) The USACE SOH program.

(3) Section 19 of the OSH Act.

(4) Executive Order 12196.

(5) SOH standards applicable to the assigned workplaces.

(6) Procedures for reporting hazards.

(7) Procedures for reporting and investigating allegations of reprisal.

(8) Procedures for the abatement of hazards.

(9) Procedures for reporting accidents and conducting investigations.

(10) Any other appropriate rules and regulations.

1-4. Roles and Responsibilities.

a. General Employees. All employees are responsible for SOH program implementation in the workplace. Each employee is responsible for complying with applicable SOH requirements, wearing prescribed SOH equipment, reporting hazardous or unsafe conditions or activities, preventing avoidable accidents, and working in a safe manner and the following: (1-4.a)

(1) While on duty, employees must not use or be under the influence of alcohol, narcotics, intoxicants, or similar performance or mind-altering substances.

(2) Employees must report all hazards, accidents, and near misses immediately to their supervisor.

(3) Employees should be involved in the development of AHAs for the work activities they perform. Employees must review applicable AHAs before beginning work and adhere to the necessary requirements during the performance of such activities.

(4) While on/visiting a USACE site that is controlled by a contractor and a contractor-managed Accident Prevention Plan (APP) (for example, QARs on construction sites), USACE employees must comply with the contractor's APP and associated SOH programs and requirements (for example, PPE, Fall Protection, Hazardous Energy Control (HEC), Diving, Blasting).

(5) All USACE employees, in coordination with their supervisor, must develop a PHA upon initial assignment to a position and review and revise it at least annually or when position duties or conditions change (see para 1-8.c).

b. Collateral Duty Safety Officer (CDSO). CDSOs are responsible for overseeing and ensuring implementation of the SOH program at their assigned work site(s) to include the following: (1-4.b)

(1) Ensure hazards identified in AHAs are appropriately addressed.

(2) Ensure employees are knowledgeable of potential task hazards and required controls to be used.

(3) Provide feedback to employees and supervisors on the work activities performed and potential ways to improve the safety of the activity.

(4) Seek support and information from the local SOHO if there is a reported safety concern or someone becomes injured or ill.

(5) Give assigned safety duties proper priority.

(6) Report safety-related matters directly to assigned supervisor.

(7) Coordinate activities with the local SOHO.

c. Quality Assurance Representative (QAR). QARs are responsible for ensuring contract work is performed according to the contract and this manual (for example, APP, AHA). As part of their overall responsibility for ensuring contractor conformance and safety, the QAR must conduct daily SOH inspections and document any findings in their daily logs according to paragraph 1-5.b. (1-4.c)

d. Supervisors. Supervisors are ultimately responsible for SOH program implementation at their work sites and ensuring that all employees comply with the necessary requirements to include the following: (1-4.d)

(1) Ensure no person is required, instructed, or allowed to work in surroundings or under conditions that are unsafe or dangerous to their health.

(2) Designate CDSOs in writing, see non-mandatory ENG Form 6283, Collateral Duty Safety Officer Designation Letter) (see para 1-10.c).

(3) Verify site-specific SOH plans are created, signed, and implemented when required (see para 1-10.d).

(4) Remove employees from exposure to work hazards or the work site when they are observed acting in an unsafe manner, or otherwise pose a potential SOH threat to themselves or others. Employees may return to the work environment after appropriate supervisory action has occurred (for example, re-training on proper safe procedures, threat removed).

(5) Attend monthly meetings for all supervisors on the project work site. Conduct frequent meetings, at a minimum monthly, for all employees to discuss SOH issues. (See para 1-8.f)

(6) Report all accidents and near misses to the SOHO according to ER and EP 385-1-99. No supervisor may decline to accept a report of an accident or near miss from a subordinate.

(7) Immediately notify the local SOHO of any OSHA or other regulatory inspections.

(8) Enforce the drug-free workplace requirements. Immediately notify security to employees found to be under the influence of or consuming such substances from the work site.

(9) Ensure that all employee-required SOH training is completed prior to work according to paragraph 3 of each chapter of this manual.

(10) Ensure training in handling emergency situations that may arise from project activities or equipment operations is provided. All persons who may have an occasion to use emergency and rescue or lifesaving equipment must be familiarized with the equipment location, trained in its proper use, be instructed in its capabilities and limitations, and medically qualified for its use.

(11) Ensure the AHA process is implemented according to paragraph 1-6. Ensure all AHAs are developed by CPs for all activities as required by this manual. See paragraph 6 of each chapter of this manual.

(12) Ensure that all employees are physically and medically qualified to perform the duties they are assigned.

(13) Ensure visitors are escorted, properly protected, are wearing or provided the appropriate PPE, and receive a safety brief on the hazards to be expected on the site and the SOH controls required (see para 1-8.a).

(14) Ensure the PHA process is implemented according to paragraph 1-8.c, including that each employee has a PHA current with the job duties they perform and that they are reviewed and updated at least annually.

(15) Assist with the implementation of CE-SOHMS.

e. Competent Person (CP). (1-4.e)

(1) Develop AHAs for all activities as required by this manual (see para 1-6).

(2) Oversee work activities as required by this manual. When conditions arise that are unsanitary, hazardous, or dangerous to employees, take prompt corrective measures to eliminate them.

f. Qualified Person (QP). (1-4.f)

(1) Develop AHAs for all activities as required by this manual (see para 1-6).

(2) Provide guidance and perform work activities as required by this manual.

g. Command. Each USACE Command is responsible for establishing and maintaining a SOH program that complies with this manual and federal, state, and local requirements. Implement the CE-SOHMS according to ES 16009. (1-4.g)

h. Project Manager (PM)/Program Manager (PgM). The PM/PgM, in coordination with the local SOHO, is responsible for ensuring SOH integration into all aspects of work planning according to the USACE Project Deliver Business Process Manual and paragraph 1-7.a to include the following: (1-4.h)

(1) Ensure that a site-specific SOH Plan is developed for funded projects and incorporated into each Project Management Plan (PMP) or Program Management Plan (PgMP) and ensure that all requirements are executed throughout the life cycle of the project (see para 1-7.a).

(2) Coordinate all highly complex or high-hazard projects with the local SOHO.

(3) Collaborate with the customer and the local SOHO on project safety goals and objectives and communicate these through the PMP or PgMP SOH Plan and PDT meetings.

(4) Ensure that coordination between local SOHOs of the design district and the construction district, if applicable, occurs during the development of the PMP or PgMP.

(5) Ensure that identified hazards, control mechanisms, and risk acceptance are formally communicated to all project stakeholders.

(6) Ensure that the current UFGS 01 35 26, Governmental Safety Requirements in effect on the date of solicitation is used in all USACE contract work administered on behalf of the USACE under the provisions of FAR Clause 52.236-13 (that is, 48 CFR 52.236-13) and on other contracts as deemed appropriate based on the risk assessment.

(7) Coordinate with the local SOHO in determining SOH requirements (for example, limited scope or maintenance and service contracts based on the scope of work and associated hazards).

(8) Include FAR Clause 52.236-13 and the Request for Proposal in Military Construction contracts.

(9) Do not include locally developed SOH requirements in contract without the concurrence of the contracting officer (KO) and local SOHO.

(10) Do not include new contract requirements (for example, more stringent, differing intent, etc.) without the specific approval of HQUSACE.

i. Contracting Officer (KO). The KO/contracting officer representative (COR) is responsible for reviewing SOH documents (for example, APPs, AHAs) for compliance with the contract, this manual, and federal, state, and local requirements, as applicable, to include the following: (1-4.i)

(1) Ensure that all site-specific SOH documents (for example, APP, AHAs) are reviewed and accepted according to this manual. Coordinate with the local SOHO or their designated appointee for assistance.

(2) Ensure that all SOH documents, including changes, revisions, and updates are reviewed and accepted prior to the initiation of work.

(3) Immediately notify the local SOHO of any OSHA or other regulatory visits.

(4) Report all accidents to the local SOHO.

(5) When an employee is deemed to be in imminent danger, immediately stop the unsafe work being performed (see FAR Clause 52.236-13).

j. Safety and Occupational Health Office (SOHO). The SOHO is ultimately responsible for SOH program management, communication, and implementation within their area of responsibility to include the following: (1-4.j)

(1) Provide technical input for all SOH program requirements (for example, CE-SOHMS, SOH Plans, AHAs, PHAs) at the request of the employee or supervisor.

(2) Identify training requirements for employees based on assigned job duties and the nature of work performed. Work with leadership to ensure employees and supervisors are appropriately trained.

(3) Assist the supervisor with development of SOH Plan(s) and AHA(s) to ensure an adequate risk management process is implemented and the lowest acceptable residual risk is achieved.

(4) Assist PMs in determining safety contract requirements (for example, limited scope or maintenance and service contracts based on the scope of work and associated hazards).

(5) Assist and provide guidance to CDSOs as appropriate.

(6) Ensure Command investigates, reviews, analyzes, and reports accident and near miss information and any associated corrective actions needed or taken. Ensure all accident reports are accurate and complete prior to forwarding to upper commands. (See para 1-8.d)

(7) Ensure that the supervisor reviewing and approving SOH documents (for example, SOH plan, AHA, PHA) are competent to do so and provide assistance when necessary.

(8) Ensure a USACE SOH Professional is onsite full time for all USACE activities with a high potential for injury or illness or a residual RAC on the AHA is coded as high or extremely high.

(9) Ensure annual workplace inspections are performed according to paragraph 1-5.c.

(10) OSHA inspections.

(a) Report all OSHA inspections within two duty days for the event to Division SOHO, Headquarters USACE Safety Office (HQUSACE-SO), and the U.S. Army Combat Readiness Center (USACRC).

(b) Report all OSHA Notices of Violations (NOV) within two business days of the NOV issuance to Division SOHO, HQUSACE-SO, and the USACRC.

(c) Submit recommendations for appeals within four duty days of the NOV issuance date to Division SOHO, and HQUSACE-SO.

(d) If HQUSACE-SO endorses the appeal, submit the endorsement and recommendations for appeals within five duty days of the NOV issuance date to the USACRC.

(e) Report all abatements and abatement dates for all violations to the OSHA local office. Submit with a courtesy copy to the USACRC and HQUSACE-SO upon completion.

(11) Provide OSHA or other regulatory agency inspection documentation (for example, citations, reports) to division SOHO and HQUSACE-SO.

(12) Ensure accurate reports of accident and near miss data is entered into ENGLink according to ER and EP 385-1-99.

(13) Local USACE organizations may develop Standard Operating Procedures (SOPs) to implement the provisions contained within this manual, but may not implement new requirements (for example, more stringent, differing intent, etc.) without the specific approval of HQUSACE.

1-5. Inspection Requirements.

a. External Agency Inspections. Immediately notify the local SOHO of any OSHA or other regulatory agency inspection and provide the local SOHO an opportunity to accompany the inspector on the inspection. The inspection will not be delayed due to non-availability of the SOHO. (1-5.a)

(1) Provide the local SOHO with a copy of any citations or reports issued by the inspector and any corrective action responses to the citation(s) or report(s).

(2) The local SOHO will provide a copy of any citations or reports issued by the inspector and any corrective action responses to the citation(s) or report(s) to division and HQUSACE-SO.

b. Quality Assurance Representative (QAR) Inspections. QAR personnel, as part of their QAR responsibilities, must conduct and document daily SOH inspections of the work sites, material, and equipment to ensure compliance with this manual. These inspections must be documented in the daily logs. (1-5.b)

c. USACE Annual Workplace Inspections. All USACE workplaces must be inspected at least annually according to Standard Army Safety and Occupational Health Inspection procedures (see DA PAM 385-10). All violations of standards identified must be entered on DA Form 4754 or equivalent. RAC 1 and RAC 2 safety deficiencies greater than 15 days old and health deficiencies greater than 30 days old must be recorded on DA Form 4753 or equivalent. (1-5.c)

d. CDSO Inspections. CDSO, as part of their SOH responsibilities, must conduct and document daily SOH inspections of the work sites, material, and equipment to ensure compliance with this manual. These inspections must be documented in the daily logs. (1-5.d)

e. Supervisor Inspections. Supervisors, as part of their SOH responsibilities, should conduct and document frequent SOH inspections (minimum of monthly) of the work sites, material, and equipment to ensure compliance with this manual. (1-5.e)

1-6. Activity Hazard Analysis (AHA) Requirements.

The requirements of this paragraph apply to all AHAs required by this manual. Specific AHA requirements are identified in paragraph 6 of each chapter in this manual.

a. Risk management is a business process that requires planning to ensure risk is reduced to an acceptable level prior to performing work activities. Risk management provides consistent and systematic identification and communication of risks, consequences, and potential actions to mitigate those risks. Unidentified and unmanaged hazards and their associated risks impede successful missions, undermine readiness, decrease morale, and deplete resources. A properly documented risk assessment serves as evidence that leadership decision-making was based on sound judgment and reasonable principles. Leadership and management at every level must exercise risk management. Risk management must be integrated into all phases of work to ensure risk decisions are made at the appropriate level, no unnecessary risk is taken, and the process is applied consciously. Effective risk management requires the following steps (see para 1-10.b): (1-6.a)

(1) Step 1. Identify all potential hazards associated with the task prior to work.

(2) Step 2. Assess identified hazards to determine probability and potential severity of occurrence (that is, risk).

(3) Step 3. Develop adequate controls to mitigate hazard and reduce probability and risk (see para 1-6.a).

(4) Step 4. Implement controls to ensure all workers know, understand, and implement required controls to reduce risk.

(5) Step 5. Continuously supervise and evaluate controls to ensure they are fully implemented, adequate, and effective at reducing risk. When needed, stop work to make corrections, modify, or add more controls, to ensure risk is managed.

Note. The USACE uses many tools to aid with risk management implementation. One of these tools is the AHA.

b. Hazard Mitigation. Analysis of hazards and implementation of control measures is a vital element to the risk management process and reducing the residual risk to an acceptable level. Use the following hierarchy of controls, listed from most effective to decreasing effectiveness, to identify control measures to be implemented to eliminate or control hazards to an acceptable level: (1-6.b)

Note. There may be some situations or activities when more than one control measure or level of controls may need to be implemented to adequately control the hazard(s) to an acceptable level.

(1) Elimination/Substitution. Elimination/substitution involves removing the hazard from the work area. This may be accomplished by modifying structures, changing work processes, or substituting equipment so that persons are not exposed to the hazard(s).

(2) Engineering Controls. Engineering controls isolate or separate the hazard(s) from the general work area and personnel exposure. A common engineering control is physical barriers that prevent contact/exposure to the hazard(s) (for example, guardrails, machine guards, containment).

(3) Administrative Controls. Administrative controls involve work practices or procedures to govern/control the way persons work so that hazardous situations or conditions can be avoided. A common example of an administrative control is training, in that persons are trained in proper procedures so that they do not subject themselves or others to hazards.

(4) PPE. PPE is equipment worn or used by persons performing work with hazards to minimize the effects of exposure to the hazard(s). PPE includes hard hats, safety glasses, safety shoes, hearing protection, respirators, etc. (See chapter 5)

Note. PPE should not be used as the only protection against a hazard. It should only be used after attempt has been made to implement higher level controls, or as a subsequent control to provide an additional layer of protection.

c. Risk Acceptance. Acceptance of risk is a serious matter; therefore, the appropriate level of leadership must accept the overall residual risk associated with a

task before its commencement. Residual risk must be communicated and accepted by the proper authority before beginning the activity. (1-6.c)

Note. The proper authority may be different in each scenario and is based on the scope of work, hazards, and associated risk.

(1) Activities that require an AHA must not begin until the AHA with the identified RAC has been reviewed, accepted, and signed by the proper approval authority.

(2) Each USACE Command must establish a process for risk acceptance for USACE activities identifying the proper acceptance authority or implement table for Risk Acceptance Matrix (see table 1-1).

Note. USACE does not accept contractor risk.

d. AHA Minimum Requirements. (1-6.d)

(1) AHAs must be prepared and documented for all field, laboratory, industrial, and maintenance activities performed. Before beginning each work activity, task, or DFOW, an initial AHA must be prepared to ensure minimum safety requirements are adequately addressed. In developing the AHA for a particular activity, the writer(s) (that is, CPs) should draw upon the expertise (for example, knowledge, skills, and experience) of the employees, supervisors, and SOH personnel. Additional AHA requirements may be found in other applicable paragraphs of this manual. See paragraph 6 of each chapter of this manual.

Note. Job Safety Analyses (JSAs), Job Hazard Analyses (JHAs), or similar risk management assessment tools are considered equivalent to, and acceptable substitutes for, AHAs as long as the data collected is the same as that required by the AHA.

(2) AHAs must be provided to and reviewed by all involved employees prior to starting the task. Each employee must document their review with a signature on the AHA or an additional signature sheet. Provide copies of signed AHAs to the supervisor or local SOHO upon request.

(3) AHAs must be readily available onsite (for example, office trailer) and accessible onsite by all employees for a period of 12 months. Workers/crews must have in their possession the current AHA that reflects current site conditions, personnel, equipment, control measures, etc. while the work is being performed.

(4) AHAs must include the following:

(a) Identify the activity/task/DFOW name, activity location, date of AHA development, name, and title of AHA preparer, and name and title of AHA acceptance authority.

(b) Define the steps to be performed for the activity/task/DFOW and the work sequences (for example, site conditions, materials, personnel) needed. Job steps should be detailed so that the reader clearly understands how that job will be accomplished (for example, how the part will be installed or removed, anticipated voltages, quantities of chemicals utilized, equipment utilized to accomplish the task, heights being accessed or trenched).

(c) List all potential hazards associated with each specific job step.

(d) List all controls required to mitigate hazards according to paragraph 1-6.a. If one layer of control cannot fully eliminate or reduce hazards to an acceptable level, put additional controls in place to reduce risk to an acceptable level (that is, low or medium where possible).

(e) Assign a RAC to each job step, to identify the residual risk that remains after controls have been applied.

(f) Assign an overall RAC to the AHA. The overall RAC must not be lower than the highest job step RAC on the AHA.

(g) Identify the equipment needed, training requirements needed of involved personnel, and any inspection requirements necessary for the activity/task/DFOW. Supervisor will designate, in writing (for example, certification, company letter) any required CP(s) and QP(s) by name for a particular activity (for example, excavation, confined space, scaffolding, fall protection, lead removal, asbestos abatement, other activities as specified by OSHA and this manual), and provide proof of competency/qualification. (See para 1-10.c)

(h) Risk acceptance according to paragraph 1-6.b. Activities that require an AHA must not begin until the AHA with RAC has been reviewed and accepted by the proper acceptance authority.

(5) Updates to the AHA. The AHA must be modified as necessary to address changing site conditions, operations, or change of CP(s) or QP(s).

(a) If the initial RAC increases due to a change made to the AHA, resubmit the AHA for acceptance prior to the start of work.

(b) Changes or updates to an AHA that do not increase the RAC are not required to be resubmitted for acceptance.

(c) If the AHA needs to be revised, work should not resume until revision is complete and provided to and reviewed by all involved employees prior to starting the task.

(d) If the work has been stopped due to safety non-compliance with this manual, site-specific SOH Plan, AHA, etc. and the AHA needs to be revised, work should not resume until revision is complete and accepted and employees have re-reviewed.

Note. For a non-mandatory formatted outline of an AHA see ENG Form 6206 (Activity Hazard Analysis) (see para 1-10.b).

1-7. Minimum Plan Requirements.

a. Site-Specific Safety & Occupational Health (SOH) Plan. Work cannot begin until the supervisor develops, signs, implements, and updates as necessary (at least annually), a site-specific SOH plan, see mandatory ENG Form 6292 (Site-Specific Safety & Occupational Health Plan Worksheet) for USACE activities where USACE employees are engaged in functions other than routine office or administrative duties (see para 1-10.d). The site-specific SOH plan will include at the minimum: (1-7.a)

Note. Such activities include operations and maintenance; recreational resource management; in-house conducted environmental restoration (investigation, design, and remediation); surveying, inspection, and testing; construction management; warehousing; transportation; research and development; and other activities when the supervisor and the local SOHO agree on the benefit of such a program for accident prevention.

(1) Signature Sheet. Include name, title, signature, email, and phone number for the following:

(a) Plan Preparer, that is the QP, CP, Project Lead, or CDSO.

(b) Plan Approver, that is the supervisor.

(2) Project Information.

(a) Project name.

(b) Project location including a map.

(c) Project description.

(3) SOH Commitment and Policy (for example, SOH Commander policy, SOH strategic goals, SOH objectives).

(4) Statement that no work will be performed unless a designated CDSO is present on the jobsite.

(5) Accident reporting and investigations.

(a) OSHA 300A requirements (see para 1-8.f).

(b) Reporting and investigate accidents according to ER/EP 385-1-99.

(6) SOH Training.

(a) List of applicable training requirements applicable to the project. See local training matrix for complete list of SOH training.

(b) Designation letter(s) for CDSO, CP, and/or QP as applicable to the project including proof of competency/qualifications (see para 1-10.c).

(7) SOH Inspections. A list of all applicable inspections required by this manual, applicable federal, state, and local requirement for this project including:

(a) Who will conduct the inspection, type of inspection and frequency of inspection.

(b) How deficiencies will be documented and tracked as required by this manual and according to local requirements (see para 1-8.f).

(8) AHA. A list of current and signed AHAs according to paragraph 1-6.

(9) Analysis of applicable site-specific plans, programs, and procedures. Applicable plans to the project will be created according to this manual, applicable federal, state, and local requirements.

(10) Occupational Health. Industrial Hygienist (IH) most recent written report and recommendations.

Note. The following requirements apply to all plans required by this manual. Specific plan requirements are identified in paragraph 7 of each chapter in this manual.

b. Emergency Plan. Ensure employee safety in case of fire, inclement weather, or other emergencies at the project location must be prepared, in writing, and reviewed with all affected employees. Emergency plans must be tested to ensure their effectiveness. (1-7.b)

(1) Plans must include evacuation procedures, routes, and rally points, the identification of critical plant operations and procedures for employees who operate critical plant operations (for example, gas line shut down, electrical systems), employee accountability following evacuation, rescue, and medical duties, means of reporting emergencies, and points of contact.

(2) Onsite emergency planning must be coordinated with off-site emergency support. Documentation of specific onsite emergency services is also required and can include written agreements, memoranda for record, telephone conversation logs, etc. Offer an onsite orientation of the project and associated hazards to the emergency services provider.

(3) Emergency alert systems must be developed, tested, and used to alert all persons likely to be affected by existing or imminent disasters and to alert and summon emergency responders.

(4) Emergency telephone numbers and reporting instructions for ambulance, physician, hospital, fire, and police must be clearly communicated to all employees and posted at the work site.

(5) Employees working alone in remote locations must be provided an effective means of emergency communications (for example, cellular phone, two-way radios, land-line telephones, remote employee tracking devices/global positioning system (GPS), or other.)

(a) The selected communications must be readily available (easily within the immediate reach) of the employee and be tested prior to the start of work to verify effective operation at the work site.

(b) Develop an employee check-in/check-out communication process to ensure employee safety.

1-8. General Requirements.

a. USACE Employee Site Control. (1-8.a)

(1) On USACE work sites, the project supervisor, with the assistance of the local SOHO and CDSO, is responsible for managing, communicating, implementing, and enforcing compliance with the accepted site-specific SOH Plan and other SOH requirements.

(2) Visitors.

(a) All visitors must be escorted by appropriate site personnel. Personnel who escort visitors are responsible for their visitors and must ensure they are properly protected.

(b) USACE project sites must maintain a stock of common PPE, such as hard hats, eye protection, ear plugs, and reflective vests, for use by visitors. Escorts must ensure the visitors are wearing the appropriate PPE and provide if necessary.

Note. If visitors can be escorted along a designated path through the site where they are not exposed to the hazards, the use of PPE is not necessary.

(c) Escorts must ensure that all visitors receive a safety brief from a person knowledgeable of the hazards to be expected on the site and the SOH controls required.

(d) Maintain an onsite visitor sign-in/out log. The designated site personnel must keep a roster of all visitors that enter the site.

b. USACE SOH Implementation and Oversight. (1-8.b)

(1) USACE SOH Professional. A SOH professional must be onsite at all times work is being performed by USACE employees that have a residual RAC of high or extremely high, or for any activity with a high potential for injury or illness.

(2) CDSO. A CDSO must be onsite at all times work is being performed by USACE employees that have a residual RAC of medium. A CDSO cannot be assigned to projects that have a residual RAC of high or extremely high.

(3) A QP or CP must be onsite at all times when work is being performed by USACE employees that have a residual RAC of low or medium.

c. Position Hazard Analysis (PHA). The PHA is a risk management tool used by USACE to identify hazards and controls for routine work tasks. It is essential that the PHA be tailored to each employee's routine tasks and hazardous activities so that both the employee and the supervisor understand the potential job hazards and risk mitigation strategies. The PHA is the first step in the hazard assessment process for employees and may not be used as a substitute for an AHA. See <https://apps.usace.army.mil/sites/PHA/Pages/Welcome.aspx>. (1-8.c)

(1) PHAs must be developed for all USACE employees upon initial assignment to a position and must be reviewed and updated at least annually, or when position duties or conditions change. Both the employee and the supervisor must be involved with PHA development and review to ensure all the hazards and risks of the job are captured and that the employee understands their responsibility for implementing the necessary control measures. Assistance may be requested from the local SOHO as needed.

(2) A generic PHA for groups of employees is not permitted. The intent is to develop an employee specific PHA that accurately describes the employee's tasks, associated hazards, and exposures along with the required controls. Supervisors can request the local SOHO to assist in developing a template PHA for their respective office.

(3) PHAs must include the following elements:

- (a) The employee's name, job title, and date of PHA development.
- (b) List all the potential hazards associated with the employee's job duties.
- (c) List all of the controls required to mitigate hazards (see para 1-6.a).
- (d) Identify the training requirements needed to perform the job duties.
- (e) Identify the medical surveillance requirements of the position.
- (f) Identify the PPE needed by the employee.

(4) Employees can attach copies of employee training certificates to the PHA for all required SOH training.

(5) Review and Acceptance. Once the PHA is complete with the necessary information, the employee must review and sign the PHA, review it with the supervisor, and then the supervisor must sign it to acknowledge concurrence with the analysis. Supervisors must ensure that employees understand SOH policies and programs and establish supervisory expectations of safe behavior. Supervisors must also discuss consequences of unsafe behavior. A signed copy of the PHA must be maintained in a location that the employee can easily access for review.

(6) Supervisors must provide completed PHAs for all employees who perform duties other than routine office work to the local SOHO. PHAs that include potential chemical or physical hazard exposures must be reviewed by the local SOHO for review and discussion of additional risk and exposure mitigation strategies.

Note. An automated PHA is available for use by all USACE commands. District SOH professionals can request the automated PHA, or utilize the templates found on the HQUSACE-SO SharePoint to develop a hard copy PHA template for their district.

d. Accident Investigation and Reporting. The reporting and associated investigation of accidents and near misses is considered a leading indicator. Utilize the ENG Form 3394 to report accidents and near misses. (1-8.d)

(1) Investigate, analyze, and report all accidents and near misses occurring incidentally to an operation, project, or facility according to ER and EP 385-1-99.

Note. Except for rescue and emergency measures, do not disturb the accident scene until it has been released by the investigating official.

(2) Notify all work-related fatalities to OSHA within eight hours and any work-related hospitalization, amputation, or loss of eye within 24 hours (see 29 CFR 1904.39).

(3) Notify the U.S. Coast Guard (USCG) if the work-related injury is considered a marine casualty or a vessel is involved in a marine casualty according to 46 CFR 4.05-5 and 4.05-10, a commercial diving casualty under 46 CFR 197.484.

(4) Maintain records of all first aid treatments and provide them to the SOHO and the supervisor upon request.

(5) Records must include, at a minimum, employee's name, job title, date, and type of accident, causes and corrective actions taken (for example, AHA review, process changes, establishment of controls, personnel qualifications, and training).

e. Physical Qualifications of Employees. (1-8.e)

(1) Some factors to be considered in making work assignments are strength, endurance, agility, coordination, and visual and hearing acuity.

(2) At a minimum, employees must meet the physical requirements for specific job tasks and hazards as required by this manual, the position, the job description, OSHA guidelines, applicable Department of Transportation (DOT) regulations or applicable USCG requirements.

(3) Record medical documentation using applicable medical screening and medical history and examination forms and maintain them according to 5 CFR 293.

(4) While on duty, employees must not use or be under the influence of alcohol, narcotics, intoxicants, or similar performance or mind-altering substances. Supervisor must enforce the drug-free workplace requirements. Employees found to be under the influence of or consuming such substances will be immediately removed from the jobsite.

(5) Any employee under a physician's treatment and taking prescribed narcotics or any medication that may prevent them being ready, willing, and able to safely perform position duties, must provide a medical clearance statement to their supervisor.

f. SOH Communications. (1-8.f)

(1) Communicate all SOH program information, documents, signs, and tags to employees in a language that they understand. Work sites with non-English speaking employees must have onsite interpreters and translators that are fluent in all the spoken language(s).

(2) SOH Bulletin Board. All work sites must establish and maintain a SOH bulletin board. Where site, duration, or logistics of a project do not facilitate a bulletin board, an alternative, local SOHO-accepted method (for example, binder, digital) may be deemed as meeting the requirement for a bulletin board. The alternative method must include all mandatory information for employee and visitor review:

(a) A map denoting the route to the nearest emergency care facility.

(b) Emergency phone numbers.

(c) A copy of the most current site-specific SOH plan on or adjacent to the bulletin board or post a notice on the bulletin board stating the location of the plan. Locate the plan onsite and make it accessible to all employees.

(d) Post OSHA Form 300A from February 1 to April 30 of the year following the issuance of this form (see <https://www.osha.gov/recordkeeping/forms>). Mount it on or adjacent to the bulletin board and make it accessible to all employees. See 29 CFR 1904, in OSHA's recordkeeping rule, for further details on the access provisions for these forms.

(e) Mount a copy of the SOH deficiency tracking log on or adjacent to the bulletin board or post a notice on the bulletin board stating the location where it may be accessed by all employees upon request.

(f) SOH promotional posters.

(g) OSHA Safety and Health Poster.

(h) A copy of the hazardous material inventory, identification of use, approximate quantities, and a site map detailing location as required by this manual.

(3) Deficiency Log and Hazard Tracking System. Each USACE project, facility, field office must establish and maintain a current SOH deficiency tracking system that lists and monitors the status of SOH deficiencies in chronological order. The tracking system provides useful information that must be used to evaluate the effectiveness of the SOH Program. A monthly evaluation of the data should be discussed in the SOH meeting with everyone on the project. The deficiency log must be posted on the SOH bulletin board or post a notice on the bulletin board stating its location. The log must contain the following:

(a) Date deficiency identified.

(b) Description of deficiency.

(c) Corrective action.

(d) Name of person responsible for correcting deficiency.

(e) Projected resolution date.

(f) Date resolved.

(4) Safety Meetings. Safety meetings must be conducted on project sites to review past activities, plan for new or changed operations, review pertinent aspects of appropriate AHAs, establish safe working procedures for anticipated hazards, and provide pertinent SOH training and motivation.

(a) Meetings must be conducted frequently, at a minimum monthly, for all supervisors on the project location and at least once a week for all workers.

(b) Document the meetings. Include the date, persons in attendance, subjects discussed, and names of individual(s) who conducted the meeting. Maintain the documentation and furnish copies to the supervisor or local SOHO on request.

g. Requests for information. The following process will be used for requesting information of a requirement contained in this manual: (1-8.g)

(1) Official requests for information must be submitted through the local USACE SOHO who will submit the request through their SOH chain of command using the HQUSACE-SO SharePoint located at [https://team.usace.army.mil/sites/HQ/SO/Pages/Variations and Waivers.aspx](https://team.usace.army.mil/sites/HQ/SO/Pages/Variations_and_Waivers.aspx).

(2) HQUSACE-SO will have at least 15 business days from date of receipt to consider the request and to render a written response.

h. Requests for interpretation, variances, and waivers. Within the Corps of Engineers interpretation, variances, and waivers to provisions of this manual require the approval of the Chief of Safety and Occupational Health, HQUSACE. Variances, and waivers must provide an equal or greater level of protection, must be substantiated with a hazard analysis of the activity, and must be documented and forwarded through channels to Chief of Safety and Occupational Health, HQUSACE. (1-8.h)

(1) Official requests for interpretation, variances, and waivers must be submitted through the local USACE SOHO who will submit the request to their SOH chain of command using the HQUSACE-SO SharePoint located at [https://team.usace.army.mil/sites/HQ/SO/Pages/Variations and Waivers.aspx](https://team.usace.army.mil/sites/HQ/SO/Pages/Variations_and_Waivers.aspx).

(2) Requester must work the action with the local USACE SOHO who must provide their concurrence or non-concurrence with justification in the HQUSACE-SO SharePoint. Request is sent from local SOHO to their SOH chain of command.

(3) The division SOHO must render a concurrence or non-concurrence with justification within five business days of receipt in the HQUSACE-SO SharePoint.

(4) HQUSACE-SO will then coordinate with the local and division SOH Managers to evaluate the request. HQUSACE-SO will have at least 15 business days from date of receipt to consider the request and to render a written decision from the Chief of Safety and Occupational Health, HQUSACE.

Note. A waiver or variance will not be carried over to other operations unless the evaluator extends the scope to include other times and operations. If warranted, HQUSACE-SO may issue a global variance based on an individual request.

Note. All contractor requests for information, interpretation, variances, and waivers will be submitted into the SharePoint for review.

1-9. Figures and Tables.

**Table 1-1
USACE Risk Acceptance Matrix**

Category of Risk	Approval Authority
Extremely High Risk	Current Division Commanding Officer
High Risk	Current District, Center, or Lab Commanding Officer
Medium Risk	Current Supervisor or Team Lead Responsible for task
Low Risk	Current Supervisor or Team Lead Responsible for task

Note:

Commands can develop and publish their own Risk Acceptance Matrix.

1-10. Checklists and Forms.

a. ENG Form 3394, U.S. Army Corps of Engineers Mishap Notification and Investigation (<https://www.publications.usace.army.mil/USACE-Publications/Engineer-Forms/>) (1-10.a)

b. ENG Form 6206, Activity Hazard Analysis (AHA) (non-mandatory) (<https://www.publications.usace.army.mil/LinkClick.aspx?fileticket=K66no-4Lv4%3d&tabid=16438&portalid=76&mid=43543>) (1-10.b)

c. ENG Form 6283, Collateral Duty Safety Officer (CDSO) Designation Letter (non-mandatory). (https://www.publications.usace.army.mil/LinkClick.aspx?fileticket=AF5Ct_odIVU%3d&tabid=16438&portalid=76&mid=43543) (1-10.c)

d. ENG Form 6292, Site-Specific Safety & Occupational Health (SOH) Plan Worksheet (mandatory). (https://www.publications.usace.army.mil/LinkClick.aspx?fileticket=a_sZKJv_I_U%3d&tabid=16438&portalid=76&mid=43543) (1-10.d)

Chapter 2

Safety and Occupational Health Program Management for Contractors

This chapter applies to all contractors performing work activities under a USACE contract including those administered on behalf of USACE. This chapter provides the overall programmatic guidance for developing, managing, and implementing a SOH program. The requirements set forth in this chapter are the foundation for the contractor SOH program and must be carried through the additional chapters in this manual.

Note. The term Government Designated Authority (GDA) is no longer applicable within this manual. GDA has been replaced with the responsibility of the KO or COR.

2-1. References.

- a. ANSI/ASSP A10.33 Safety and Health Program Requirements for Multi-Employer Projects (<https://webstore.ansi.org/>) (2-1.a)
- b. ANSI/ASSP Z490.1, Criteria for Accepted Practices in Safety, Health and Environmental Training (<https://webstore.ansi.org/>) (2-1.b)
- c. UFGS 01 35 26, Governmental Safety Requirements (<https://wbdg.org/ffc/dod/unified-facilities-guide-specifications-ufgs>) (2-1.c)
- d. 5 CFR 293, Personnel Records (<https://www.govinfo.gov/content/pkg/CFR-2020-title5-vol1/pdf/CFR-2020-title5-vol1-part293.pdf>) (2-1.d)
- e. 29 CFR 1904, Recording and Reporting Occupational Injuries and Illnesses (<https://www.govinfo.gov/content/pkg/CFR-2020-title29-vol5/pdf/CFR-2020-title29-vol5-part1904.pdf>) (2-1.e)
- f. 29 CFR 1910, Occupational Safety and Health Standards (<https://www.govinfo.gov/app/collection/cfr>) (2-1.f)
- g. 29 CFR 1926, Safety and Health Regulations for Construction (<https://www.govinfo.gov/app/collection/cfr>) (2-1.g)
- h. 46 CFR Subpart 4.05, Notice of Marine Casualty and Voyage Records (<https://www.govinfo.gov/content/pkg/CFR-2020-title46-vol1/pdf/CFR-2020-title46-vol1-part4-subpart4-05.pdf>) (2-1.h)
- i. 48 CFR 52.236-13, Accident Prevention (<https://www.govinfo.gov/content/pkg/CFR-2020-title48-vol2/pdf/CFR-2020-title48-vol2-chap1-subchapH.pdf>) (2-1.i)
- j. 49 CFR 197.484, Notice of Casualty (<https://www.govinfo.gov/content/pkg/CFR-2002-title46-vol7/pdf/CFR-2002-title46-vol7-sec197-484.pdf>) (2-1.j)

2-2. Definitions.

a. Accepted/Acceptable. A term denoting when a written procedure, practice, method, program, engineering design, or employee qualification criteria submittal, which, after a cursory review by the KO or COR, is determined to generally conform to safety and health or contractual requirements. Acceptance or acceptability in no way relieves the submitting entity from ensuring employees a safe and healthful work environment or complying with all contractual requirements and good engineering practices. (2-2.a)

b. Accident. Any unplanned event or series of events that results in death, injury, or illness to personnel, or damage to or loss of equipment or property. Within the context of this manual, accident is synonymous with mishap. (2-2.b)

c. Accident Prevention Plan (APP). A SOH plan that documents site-specific policies, responsibilities, and plan and program requirements. (2-2.c)

d. Competent Person (CP). One who is capable of identifying existing and predictable hazards in the surroundings or working conditions which are unsanitary, hazardous, or dangerous to employees, and who has authorization to take prompt corrective measures to eliminate them. (2-2.d)

e. Contracting Officer (KO)/Contracting Officer Representative (COR). The USACE representative, usually within the district or center Contracting Office. The KO is designated by the Senior Contracting Official and the COR is designated by the KO to enter and administer contracts for the Government and make determinations and findings thereon. (2-2.e)

f. Contractor Corporate Safety Official. The prime contractor's corporate official responsible for the company's SOH Program. (2-2.f)

g. Contractor Quality Control (QC). The part of quality management focused on fulfilling quality requirements of a project, product, service, or process. It includes those processes used to ensure performance meets agreed upon stakeholder requirements that are consistent with law, regulations, policies, sound technical criteria, schedules, and budget. (2-2.g)

h. Employee. A government or contractor person engaged in work on a USACE project. (2-2.h)

i. Employer. A government or contractor organization that has control over employees engaged in work on USACE projects. (2-2.i)

j. Facility. A permanent or temporary location that includes the following: building, structure, shed, tower, utility support system or utility conveyance system, swimming

pool or other open concrete structure, whether above or below grade, or any other item that is designated by KO or COR as a facility. (2-2.j)

k. First Aid. Refers to medical attention that is usually administered immediately after the injury occurs and at the location where it occurred. It often consists of a one-time, short-term treatment and requires little technology or training to administer. First aid is specifically defined by 29 CFR 1904.7. (2-2.k)

l. Hazard. Any actual or potential condition that can cause injury, illness, or death of personnel, damage to or loss of equipment or property, or contribute to mission degradation. (2-2.l)

m. Imminent Danger. Any conditions or practices in a place of employment which are such that a danger exists which could reasonably be expected to cause death or serious physical harm immediately or before the imminence of such danger can be eliminated. (2-2.m)

n. Mishap. Within the context of this manual, mishap is synonymous with accident. See definition for accident in paragraph 2-2.a. (2-2.n)

o. Near Miss. A potentially serious accident that could have resulted in personal injury, death, or property damage, damage to the environment, or illness but did not occur due to one or more factors. (2-2.o)

p. Qualified Person (QP). An individual who, by possession of a recognized degree, certificate, or professional standing, or who by extensive knowledge, training, and experience, has successfully demonstrated the ability to solve or resolve problems relating to the subject matter, the work, or the project. (2-2.p)

q. Recordable Accident. A reportable accident that meets the minimum criteria stated in this manual for aviation and ground Class A through F accidents. (2-2.q)

r. Registered Professional Engineer (RPE). A person who has been duly and currently registered and who is licensed as a professional engineer by an authority (for example, state licensure board) within the United States or its territories to practice the profession of engineering. (2-2.r)

s. Reportable Accident. All occurrences that cause injury, occupational illness, or property damage of any kind. (2-2.s)

t. Residual Risk. The level of risk remaining after controls have been identified and countermeasures selected for hazards. Risks remaining after hazard mitigation measures have been applied. (2-2.t)

u. Risk Assessment Code (RAC). The conversion of the probability and severity of a given hazard into a specific risk level based on the residual risk. The levels of risk are extremely high (E), high (H), medium (M) and low (L). (2-2.u)

v. Risk Management. A business process that includes the identification, assessment, and prioritization of risks, followed by coordinated and economical application of resources to minimize, monitor, and control the probability and/or impact of unfortunate events to an acceptable level. (2-2.v)

w. Risk Matrix. A risk management tool that is used to determine the RAC for a specific work element and the overall RAC for the activity, task, or DFOW. The risk matrix is used to evaluate the severity (that is, an approximate amount of potential harm, damage, or injury occurring) and probability (that is, likelihood of something happening) associated with a given accident (see para 2-10.a). Severity is categorized as catastrophic, critical, moderate, or negligible. Probability is categorized as frequent, likely, occasional, seldom, or unlikely. (2-2.w)

x. Site Safety and Health Officer (SSHO). A contractor employee that is responsible for overseeing and ensuring implementation of the prime contractor's SOH program according to the contract, this manual, applicable federal, state, and local requirements (see paras 2-3 and 2-4). (2-2.x)

(1) Level 1 SSHO. A designated employee with full-time SOH responsibility that meets and follows the requirements of paragraphs 2-3.b and 2-4.b.

(2) Level 2 SSHO. A designated employee with collateral duty SOH responsibility that meets and follows the requirements of paragraphs 2-3.b and 2-4.b. Level 2 SSHOs cannot be assigned to projects that have a residual RAC of high or extremely high.

(3) Level 3 SSHO. A designated QP or CP with SOH responsibility that meets and follows the requirements of paragraphs 2-3.b and 2-4.b. Level 3 SSHOs cannot be assigned to projects that have a residual RAC of high or extremely high.

(4) Alternate SSHO. An employee that meets the definition of the contract-required level SSHO but is not the primary SSHO.

y. Site of Work. The primary location of the work. The physical place(s) where the work called for in the contract will remain when work on it is completed, or the secondary location of the work, if any, which is any other site where a significant portion of work is performed, provided that such site is established specifically for the performance of the contract or project. (2-2.y)

z. Visitor. Anyone who is not assigned to work at the site of work, either permanently or temporarily, that comes to the site of work for short-term action (for example, inspections, meetings, deliveries). (2-2.z)

2-3. Personnel Required Qualification/Training.

a. General Employee-Required Qualifications and Training. The requirements in this chapter apply to all trainings and qualifications outlined in this manual. See paragraph 3 of each chapter for applicable training and qualification requirements. (2-3.a)

(1) Employers must provide their employees all required SOH training as required by this manual, applicable federal, state, and local requirements.

(2) All SOH training must be conducted by a QP or CP, as required. Trainers must have subject matter expertise (that is, knowledge, skills, and abilities related to the topic) and experience delivering training.

(3) Develop and deliver training according to ANSI Z490.1.

(4) Evaluate trainees to ensure they meet and understand the proposed objective(s).

(5) Document all training. Records must include the following:

(a) The date, location, and duration of the training.

(b) Name and description of the training.

(c) Name(s) of trainer(s).

(d) Training materials used.

(e) Name(s) of training participants.

(f) Evaluation of trainees to ensure they meet and understand the proposed objective(s). Document evaluation result of each participants (for example, pass, fail).

(6) Indoctrination Training. Provide employees SOH indoctrination training based on the existing SOH program and applicable federal, state, and local requirements prior to the start of work. The training must include the following:

(a) Requirements and responsibilities for accident prevention and the maintenance of safe and healthful work environments.

(b) General SOH policies and procedures and pertinent provisions of this manual.

(c) Employee and supervisor responsibilities for reporting all accidents and near misses.

(d) Provisions for medical facilities and emergency response and procedures for obtaining medical treatment or emergency assistance.

(e) Procedures for reporting and correcting unsafe conditions or practices.

(f) Job hazards and the means to control and eliminate those hazards, including applicable Activity Hazard Analyses (AHA) (see para 2-6).

b. Site Safety and Health Officer (SSHO). (2-3.b)

(1) Level 1 SSHO.

(a) Initial SOH Training. All Level 1 SSHOs must receive OSHA 30-hour general industry or construction safety training. Training may be web-based if permitted by OSHA. In lieu of formal OSHA-30 training, SOH training covering the subjects of the OSHA 30-hour course and this manual may be accepted by the KO in coordination with the local SOHO having jurisdiction over the work. The local SOHO will evaluate the proposed equivalent training for applicability to the contract scope of work being performed.

(b) Competency Training Requirements. All Level 1 SSHOs must have maintained their competency by taking 24 hours of documented formal classroom or online SOH-related training within the past five years, and must maintain competency by taking 24 hours every three-year period for the duration of the contract. The 24 hours can be multiple classes combined.

Note. The initial SOH training (that is, OSHA 30-hour) does not meet the 24-hour competency training requirement.

Note. Hours spent as an instructor for SOH related training (for example, teaching an OSHA 10- or 30-hour class, or a 4-hour fall protection end user training) can be considered for hours spent training, but each course can only be used for hours once (for example, instructing 4-hour fall protection end user training three times a year only counts for 4-hours of training).

(c) Experience Requirements. All Level 1 SSHOs must have at least five years of cumulative safety experience, within the last ten years, managing or implementing a SOH program on projects similar in industry type, size, and complexity as the project described in the contract scope of work.

Note. If the Level 1 SSHO has a safety-related degree, third-party, nationally accredited (for example, American National Standards Institute (ANSI), National Commission for Certifying Agencies (NCCA), Council on Engineering and Scientific Specialty Boards (CESB) SOH-related certification or designation requiring a minimum of three years of experience to obtain, only three years of experience is needed.

Note. The KO in coordination with the local SOHO may adjust the training and experience requirements.

(2) Level 2 SSHO.

(a) Initial SOH Training. All Level 2 SSHOs must receive OSHA 30-hour general industry or construction safety training. Training may be web-based if permitted by OSHA. In lieu of formal OSHA-30 training, SOH training covering the subjects of the OSHA 30-hour course and this manual may be accepted by the KO in coordination with local SOHO having jurisdiction over the work. The local SOHO will evaluate the proposed equivalent training for applicability to the contract scope of work being performed.

(b) Competency Training Requirements. All Level 2 SSHOs must have maintained their competency by taking 24 hours of documented formal classroom or online SOH-related training within the past five years, and must maintain competency by taking 24 hours every three-year period for the duration of the contract. The 24 hours can be multiple classes combined.

Note. The initial SOH training (that is, OSHA 30-hour) does not meet the 24-hour competency training requirement.

Note. Hours spent as an instructor for SOH related training (for example, teaching an OSHA 10- or 30-hour class, or a 4-hour fall protection end user training) can be considered for hours spent training, but each course can only be used for hours once (for example, instructing 4-hour fall protection end user training three times a year only counts for 4-hours of training).

(c) Experience Requirements. All Level 2 SSHOs must have at least three years of cumulative safety experience, within the last 10 years, managing or implementing a SOH program on projects similar in industry type, size, and complexity as the project described in the contract scope of work.

Note. If the Level 2 SSHO has a safety-related degree, third-party, nationally accredited (for example, ANSI, NCCA, CESB SOH-related certification or designation requiring a minimum of two years of experience to obtain, only two years of experience is needed.

Note. The KO in coordination with the local SOHO may adjust the training and experience requirements.

(3) Level 3 SSHO. All Level 3 SSHOs must be a designated QP or CP according to paragraph 2-2 that has experience which enables identification of hazards and implementation of controls for the work being performed.

2-4. Roles and Responsibilities.

a. General Employees. All employees are responsible for SOH program implementation in the workplace. Each employee is responsible for complying with applicable SOH requirements, wearing prescribed SOH equipment, reporting hazardous or unsafe conditions or activities, preventing avoidable accidents, and working in a safe manner and will. (2-4.a)

(1) While on duty, employees must not use or be under the influence of alcohol, narcotics, intoxicants, or similar performance or mind-altering substances.

(2) All employees must report all hazards, accidents, and near misses immediately to their employer or supervisor.

(3) All employees should be involved in the development of AHAs for the work activities they perform. Employees must review applicable AHAs before beginning work and adhere to the necessary requirements during the performance of such activities.

(4) While on or visiting a USACE site that is controlled by a contractor and a contractor-managed APP (for example, QARs on construction sites), USACE employees must comply with the contractor's APP and associated SOH programs and requirements (for example, PPE, Fall Protection, HEC, Diving, Blasting).

b. Site Safety and Health Officer (SSHO). SSHOs must be present at the site of work and located so they have full mobility and reasonable access to all major work operations occurring during the shift. SSHOs are responsible for overseeing and ensuring implementation of the prime contractor's SOH program according to the contract, this manual, applicable federal, state, and local requirements to include the following: (2-4.b)

(1) Report to the corporate safety official, senior PM, or corporate official.

(2) Maintain applicable safety reference material at the site of work including this manual, Safety Data Sheets (SDSs), APP, manufacturer instructions, etc.

(3) Conduct daily SOH inspections according to paragraph 2-5.b and maintain a SOH deficiency tracking system according to paragraph 2-8.f(3).

(4) Report and investigate all accidents and near misses and complete required accident report ENG Form 3394.

(5) Attend all pre-construction conferences, tail-gate meetings, and pre-work meetings, to include preparatory meetings and periodic in-progress meetings.

(6) Conduct on-going evaluations of the APP throughout the life of the project to ensure it is current and site-specific. Submit changes, revisions, and updates to the APP for review and approval by the prime contractor.

(7) Ensure all project personnel comply with SOH requirements (including subcontractors and visitors).

(8) Provide and keep a record of site safety orientation and indoctrination training for all project personnel, including subcontractors (see para 2-3).

(9) Review and sign mandatory ENG Form 6282 (Site Safety and Health Officer Designation Letter) acknowledging roles and responsibilities (see para 2-10.c).

Note. If additional or alternate SSHO(s) are used on a project site or required due to contract requirements, multiple shifts, etc. the alternate SSHO(s) must abide by the same roles and responsibilities and assist the primary SSHO in the performance of the duties outlined above.

(10) Ensure visitors are escorted, properly protected, are wearing or provided the appropriate PPE, and receive a safety brief on the hazards to be expected onsite and the SOH controls required (see para 2-8.a).

c. Competent Person (CP). (2-4.c)

(1) Develop AHAs for all activities as required by this manual. Coordinate review and understanding with all project-affected employees (prime and subcontractors) and applicable host agencies/offices (see para 2-6).

(2) Oversee work activities as required by this manual. When conditions arise that are unsanitary, hazardous, or dangerous to employees, take prompt corrective measures to eliminate them.

(3) Develop and sign the site-specific APP. Coordinate review and understanding with all project-affected employees (prime and subcontractors) and applicable host agencies/offices. (See para 2-7)

d. Qualified Person (QP). Provide guidance and perform work activities as required by this manual. (2-4.d)

e. Supervisors. Supervisors are ultimately responsible for SOH program implementation at their site of work and ensuring that all employees comply with the necessary requirements to include the following: (2-4.e)

(1) Ensure no person is required, instructed, or allowed to work in surroundings or under conditions that are unsafe or dangerous to their health.

(2) Remove employees from exposure to work hazards or the site of work when they are observed acting in an unsafe manner, or otherwise pose a potential SOH threat to themselves or others. Employees may return to the work environment after appropriate supervisory action has occurred (for example, re-training on proper safe procedures, hazard removed).

(3) Attend monthly meetings for all supervisors on the site of work. Conduct weekly meetings for all employees to discuss SOH issues. (See para 2-8.g)

(4) Report all accidents and near misses according to table 2-1. No supervisor may decline to accept a report of an accident or near miss from a subordinate.

(5) Immediately notify the KO or COR and local SOHO of any OSHA or other regulatory inspections.

(6) Enforce the drug-free workplace requirements. Immediately remove employees found to be under the influence of or consuming such substances from the site of work.

(7) Ensure that all employee-required SOH training is completed prior to work according to paragraph 3 of each chapter of this manual.

(8) Ensure training in handling emergency situations that may arise from project activities or equipment operations is provided. All persons who may have an occasion to use emergency and rescue or lifesaving equipment must be familiarized with the equipment location, trained in its proper use, be instructed in its capabilities and limitations, and medically qualified for its use.

(9) Ensure the AHA process is implemented according to paragraph 2-6. Ensure all AHAs are developed by CPs for all activities as required by this manual. See paragraph 6 of each chapter of this manual.

(10) Ensure that all employees are physically and medically qualified to perform the duties they are assigned.

f. Corporate Safety Official. The contractor Corporate Safety Official is the prime contactor's corporate official that is responsible for the contractor's overall SOH program to include the following: (2-4.f)

(1) Designate all contractor SSHOs on a mandatory ENG Form 6282 (Site Safety and Health Officer Designation Letter) (see para 2-10.c) and ensure they meet minimum training and experience requirements according to paragraph 2-3.

(2) Review and approve the site-specific APP acknowledging approval with signature and date.

g. Prime Contractor. The prime contractor, in coordination with the SSHO, is ultimately responsible for SOH program management, communication, and implementation at their site of work to include the following: (2-4.g)

- (1) Be responsible for the processes, conduct, and safe completion of their work.
- (2) Ensure that all materials, documentation, and drawings intended for submission comply with the applicable contract SOH requirements. Submittals must be prepared in time to allow the contractor's QC organization to review and certify or, as required, order corrections of submittal materials prior to providing the submittal to the government.
- (3) Ensure that the APP is developed by a CP according to this manual and reviewed for compliance prior to submission to the government. Document and maintain the CP's credentials onsite and make them available for review at the request of the KO or COR.
- (4) Maintain and update the APP and AHAs as needed to ensure they reflect site-specific tasks during the contract duration. Review and approve changes, revisions, and updates and submit to the KO or COR for acceptance.
- (5) Make certain that work is not permitted to begin prior to government review and acceptance of required safety submittals.
- (6) Maintain a stock of common PPE, such as hard hats, eye protection, ear plugs, and reflective vests, for use by visitors.
- (7) Maintain an onsite visitor sign-in/out log and accurately account for all authorized visitors that enter the site.
- (8) Obtain appropriate medical and emergency assistance and identify methods for notifying fire department, law enforcement, and regulatory agencies.
- (9) Erect and maintain a SOH bulletin board in a commonly accessed area in clear view of the onsite employees (see para 2-8.f(2)).
- (10) Immediately notify the KO or COR of any OSHA or other regulatory agency inspection (see para 2-5.a).
- (11) Report all recordable accidents to the KO or COR according to table 2-1. Assist and cooperate fully with the KO or COR when accident investigation(s) are conducted. (See para 2-8.d)
- (12) Conduct and document safety meetings as according to paragraph 2-8.f(4).

(13) Ensure all employees receive SOH training as required by this manual, applicable federal, state, and local requirements prior to the start of work. See paragraphs 2-3 and 3 of all other chapters of this manual.

(14) Ensure all contractor employees (that is, prime and subcontractors) comply with the contract, this manual, applicable federal, state, and local requirements.

(15) Ensure no person is required, instructed, or allowed to work in surroundings or under conditions that are unsafe or dangerous to their health.

h. Contractor Quality Control (QC). Conduct daily SOH inspections and document the findings in daily logs (see para 2-5.b). (2-4.h)

2-5. Inspection Requirements.

a. External Agency Inspections. Immediately notify the KO or COR and local SOHO of any OSHA or other regulatory agency inspection and provide the KO or COR and local SOHO an opportunity to accompany the inspector on the inspection. The inspection will not be delayed due to non-availability of the KO or COR or the SOHO. (2-5.a)

(1) Provide the KO or COR and local SOHO with a copy of any citations or reports issued by the inspector and any corrective action responses to the citation(s) or report(s).

(2) The local SOHO will provide a copy of any citations or reports issued by the inspector and any corrective action responses to the citation(s) or report(s) to division and HQUSACE-SO.

b. Contractor SOH Inspections. (2-5.b)

(1) The APP must provide for frequent safety inspections and audits to be conducted by the QC and SSHO. Inspections of the work sites, material, and equipment to ensure compliance with the APP and this manual must be conducted at least daily by the SSHO and QC. These inspections must be documented on a written log that includes the name of the inspector, date of inspection, areas and operations inspected, identified hazards, recommended corrective actions, responsibility for address, and estimated and actual dates of corrections.

(a) Provide the inspection report for inclusion in the contractor's daily production report (for example, daily QC reports) and make them available to the KO or COR or local SOHO upon request.

(b) Conduct follow-up inspections to ensure correction of any identified deficiencies and document them in inspection reports.

(2) The SSHO must establish and maintain a deficiency tracking system that lists and monitors outstanding deficiencies until resolved according to paragraph 2-8.f(3).

2-6. Activity Hazard Analysis (AHA) Requirements.

The requirements of this chapter apply to all AHAs required by this manual. Specific AHA requirements are identified in paragraph 6 of each chapter in this manual.

a. Risk management is a business process that requires planning to ensure risk is reduced to an acceptable level prior to performing work activities. Risk management provides consistent and systematic identification and communication of risks, consequences, and potential actions to mitigate those risks. Unidentified and unmanaged hazards and their associated risks impede successful missions, undermine readiness, decrease morale, and deplete resources. A properly documented risk assessment serves as evidence that leadership decision-making was based on sound judgment and reasonable principles. Leadership and management at every level must exercise risk management. Risk management must be integrated into all phases of work to ensure risk decisions are made at the appropriate level, no unnecessary risk is taken, and the process is applied consciously. Effective risk management requires the following steps (see para 2-10.a): (2-6.a)

(1) Step 1. Identify all potential hazards associated with the task prior to work.

(2) Step 2. Assess identified hazards to determine probability and potential severity of occurrence (that is, risk).

(3) Step 3. Develop adequate controls to mitigate hazard and reduce probability and risk (see para 2-6.a).

(4) Step 4. Implement controls to ensure all workers know, understand, and implement required controls to reduce risk.

(5) Step 5. Continuously supervise and evaluate controls to ensure they are fully implemented, adequate, and effective at reducing risk. When needed, stop work to make corrections, modify, or add more controls, to ensure risk is managed.

Note. There are many tools to aid with risk management implementation. One of these tools is the AHA.

b. Hazard Mitigation. Analysis of hazards and implementation of control measures is a vital element to the risk management process and reducing the residual risk to an acceptable level. Use the following hierarchy of controls, listed from most effective to decreasing effectiveness, to identify control measures to be implemented to eliminate or control hazards to an acceptable level: (2-6.b)

Note. There may be some situations or activities when more than one control measure or level of controls may need to be implemented to adequately control the hazard(s) to an acceptable level.

(1) Elimination/Substitution. Elimination/substitution involves removing the hazard from the work area. This may be accomplished by modifying structures, changing work processes, or substituting equipment so that persons are not exposed to the hazard(s).

(2) Engineering Controls. Engineering controls isolate or separate the hazard(s) from the general work area and personnel exposure. A common engineering control is physical barriers that prevent contact/exposure to the hazard(s) (for example, guardrails, machine guards, containment).

(3) Administrative Controls. Administrative controls involve work practices or procedures to govern/control the way persons work so that hazardous situations or conditions can be avoided. A common example of an administrative control is training, in that persons are trained in proper procedures so that they do not subject themselves or others to hazards.

(4) PPE. PPE is equipment worn or used by persons performing work with hazards to minimize the effects of exposure to the hazard(s). PPE includes hard hats, safety glasses, safety shoes, hearing protection, respirators, etc. (See chapter 5)

Note. PPE should not be used as the only protection against a hazard. It should only be used after attempt has been made to implement higher level controls, or as a subsequent control to provide an additional layer of protection.

c. Risk Acceptance. Acceptance of risk is a serious matter; therefore, the appropriate level of leadership must accept the overall residual risk associated with a task before its commencement. Residual risk must be communicated and accepted by the proper authority before beginning the activity. (2-6.c)

Note. The proper authority may be different in each scenario and is based on the scope of work, hazards, and associated risk.

(1) Activities that require an AHA must not begin until the AHA with the identified RAC has been reviewed, accepted, and signed by the proper approval authority.

(2) Prime contractors must establish an internal process that outlines appropriate acceptance authority based on each level of residual risk. The risk acceptance process and acceptance authority personnel must be included in the APP.

Note. USACE does not accept contractor risk.

d. AHA Minimum Requirements. (2-6.d)

(1) AHAs must be prepared and documented for all field, laboratory, industrial, and maintenance activities performed. Before beginning each work activity, task, or DFOW, an initial AHA must be prepared to ensure minimum safety requirements are adequately addressed. In developing the AHA for a particular activity, the writer(s) (that is, CPs) should draw upon the expertise (for example, knowledge, skills, and experience) of the employees, supervisors, and SOH personnel. Additional AHA requirements may be found in other applicable chapters of this manual. See paragraph 6 of each chapter of this manual.

Note. JSAs, JHAs, or similar Risk Management assessment tools are considered equivalent to, and acceptable substitutes for AHAs as long as the data collected is the same as that required by the AHA.

(2) AHAs must be provided to and reviewed by all involved employees prior to starting the task. Each employee must document their review with a signature on the AHA or an additional signature sheet. Provide copies of signed AHAs to the KO or COR upon request.

(3) AHAs must be readily available onsite (for example, office trailer) and accessible onsite by all employees for a period of 12 months, or for contracted work, the length of the contract. Workers/crews must have in their possession the current AHA that reflects current site conditions, personnel, equipment, control measures, etc. while the work is being performed.

(4) AHAs must include the following:

(a) Identify the activity/task/DFOW name, contractor name and contract number, project location, date of AHA development, name, and title of AHA preparer, and name and title of AHA acceptance authority.

(b) Define the steps to be performed for the activity/task/DFOW and the work sequences (for example, site conditions, materials, personnel) needed. Job steps should be detailed so that the reader clearly understands how that job will be accomplished (for example, how the part will be installed or removed, anticipated voltages, quantities of chemicals utilized, equipment utilized to accomplish the task, heights being accessed or trenched).

(c) List all potential hazards associated with each specific job step.

(d) List all controls required to mitigate hazards according to paragraph 2-6.a. If one layer of control cannot fully eliminate or reduce hazards to an acceptable level, put additional controls in place to reduce risk to an acceptable level (that is, low or medium where possible).

(e) Assign a RAC to each job step, to identify the residual risk that remains after controls have been applied.

(f) Assign an overall RAC to the AHA. The overall RAC must not be lower than the highest job step RAC on the AHA.

(g) Identify the equipment needed, training requirements needed of involved personnel, and any inspection requirements necessary for the activity/task/DFOW. Employer will designate, in writing (for example, certification, company letter) any required CP(s) and QP(s) by name for a particular activity (for example, excavation, confined space, scaffolding, fall protection, lead removal, asbestos abatement, other activities as specified by OSHA and this manual), and provide proof of competency/qualification.

(h) Risk acceptance according to paragraph 2-6.b. Activities that require an AHA must not begin until the AHA with RAC has been reviewed and accepted by the proper acceptance authority.

Note. Contractors must submit their accepted AHAs to the KO or COR for review and acceptance to ensure contractual requirements are met.

(5) Updates to the AHA. The AHA must be modified as necessary to address changing site conditions, operations, or change of CP(s) or QP(s).

(a) If the initial RAC increases due to a change made to the AHA, resubmit the AHA for acceptance prior to the start of work.

(b) Changes or updates to an AHA that do not increase the RAC are not required to be resubmitted for acceptance.

(c) If the AHA needs to be revised, work should not resume until revision is complete and provided to and reviewed by all involved employees prior to starting the task.

(d) If the work has been stopped due to safety non-compliance with this manual, APP, AHA, etc. and the AHA needs to be revised, work should not resume until revision is complete and accepted and employees have re-reviewed.

Note. For a non-mandatory formatted outline of an AHA, see ENG Form 6206 (Activity Hazard Analysis) (see para 2-10.a).

2-7. Minimum Plan Requirements.

a. General Plan Requirements. The following requirements apply to all plans required by this manual. Specific plan requirements are identified in paragraph 7 of each chapter in this manual. (2-7.a)

(1) Plans must be developed by each contractor as required by the work being performed.

(2) All plans and other SOH-related submittals must be submitted as part of the APP to the KO or COR for review and acceptance.

(3) Work cannot begin until the plan or other SOH-related submittals are reviewed and accepted by the KO or COR.

b. Accident Prevention Plan (APP). An APP is a written site-specific SOH plan that documents project, contract, and job-specific potential hazards in the workplace, and the company policies, controls, and work practices that will be used to minimize those hazards. They are an integral part of the planning and risk management process. The APP must be developed by a CP and reviewed and approved by the prime contractor and corporate safety official. Upon contractor approval, the plan must be submitted to the KO or COR for review and acceptance prior to the performance of any work. No contract work can begin without a KO or COR accepted APP. APPs must include the following: (2-7.b)

(1) The APP must be written in English and articulate the specific work, work process, equipment, and materials to be used, hazards pertaining to the contract work, and the control measures that will be implemented. Follow the mandatory ENG Form 6293 (Accident Prevention Plan Worksheet). (See para 2-10.d)

(2) It is understood that at the time of APP submission, there may be unknown portions of the work. Include all known information in the APP prior to the start of work. Project-specific information that is yet to be known (for example, subcontractors to be used, type of fall protection to be used at a certain point in time, specific cranes or other load handling equipment (LHE) to be brought at the site of work, must be added and submitted prior to each preparatory phase/meeting, along with the appropriate AHAs. (See para 2-10.a)

(3) The SSHO must conduct on-going evaluations and updates of the APP throughout the life of the project to ensure it is up to date and site specific. Changes, revisions, and updates to the APP must be reviewed and approved by the contractor and submitted to the KO or COR for acceptance).

(a) Include measures to be taken to control potential hazards associated with materials, services, or equipment provided by vendors, contractors, subcontractors, etc.

(b) Address any unusual or unique aspects or hazards of the project or activity.

(4) The completed APP (that is, has been reviewed and approved by the contractor and accepted by the KO or COR) must be available on the site of work at all times and be accessible to all employees. At minimum, a copy of the most current APP

must be posted on the SOH bulletin board, or a notice posted on the board stating the location of the plan.

c. Emergency Plan. Emergency plans to ensure employee safety in case of fire, inclement weather, or other emergencies at the project location must be prepared, in writing, and reviewed with all affected employees. Emergency plans must be tested to ensure their effectiveness. (2-7.c)

(1) Plans must include evacuation procedures, routes, and rally points; the identification of critical plant operations and procedures for employees who operate critical plant operations (for example, gas line shut down, electrical systems, etc.); employee accountability following evacuation; rescue and medical duties; means of reporting emergencies; and points of contact.

(2) Onsite emergency planning must be coordinated with off-site emergency support. Documentation of specific onsite emergency services is also required and can include written agreements, memoranda for record, telephone conversation logs, etc. The contractor must offer an onsite orientation of the project and associated hazards to the emergency services provider.

(3) Emergency alert systems must be developed, tested, and used to alert all persons likely to be affected by existing or imminent disasters and to alert and summon emergency responders.

(4) Emergency telephone numbers and reporting instructions for ambulance, physician, hospital, fire, and police must be clearly communicated to all employees and posted at the site of work.

(5) Employees working alone in remote locations must be provided an effective means of emergency communications (for example, cellular phone, two-way radios, land-line telephones, remote employee tracking devices/GPS, or other).

(a) The selected communications must be readily available (easily within the immediate reach) of the employee and be tested prior to the start of work to verify effective operation at the site of work.

(b) Develop an employee check-in/check-out communication process to ensure employee safety.

2-8. General Requirements.

a. Contractor Site Control. (2-8.a)

(1) On contractor site of work, the prime contractor's project management team, with the assistance of the SSHO, is responsible for managing, communicating,

implementing, and enforcing compliance with the accepted APP and other accepted SOH submittals and requirements.

(2) Visitors.

(a) All visitors must be escorted by appropriate site personnel. Personnel who escort visitors are responsible for their visitors and must ensure they are properly protected.

(b) Contractors must maintain a stock of common PPE, such as hard hats, eye protection, ear plugs, and reflective vests, for use by visitors. Escorts must ensure the visitors are wearing the appropriate PPE; provide if necessary.

Note. If visitors can be escorted along a designated safe path through the site where they are not exposed to the hazards, the use of PPE is not necessary.

(c) Escorts must ensure that all visitors receive a safety brief from a person knowledgeable on the hazards to be expected onsite and the SOH controls required.

(d) Maintain an onsite visitor sign-in/out log. The designated site personnel must keep a roster of all visitors that enter the site.

b. Contractor SOH Implementation and Oversight. (2-8.b)

(1) A Designation Letter is required for all levels of onsite SSHOs. Contractors must designate in writing all SSHOs on a mandatory ENG Form 6282 (Site Safety and Health Officer Designation Letter). Both the Corporate Safety Official and the SSHO must sign the form and submit it to the KO or COR for acceptance. If a new or additional SSHO is assigned to perform SOH duties onsite, the contractor must submit a new Designation Letter. Work must not be conducted until the KO or COR accepts ENG Form 6282 (Site Safety and Health Officer Designation Letter). The contractor must maintain a copy of the accepted form at the site of work. (See para 2-10.c)

(2) SSHO Requirements. The contractor must employ a minimum of one Level 1 SSHO at each project site to function as the primary Level 1 SSHO responsible for ensuring all site personnel are implementing SOH requirements according to the contract, this manual, applicable federal, state, and local requirements. A designated Level 1 SSHO must be at the site of work whenever work is performed).

(a) Level 1 SSHOs are not permitted to supervise non-safety personnel at the site of work.

(b) Additional or alternate SSHOs may be needed for projects with multiple sites, or shifts, or large projects. This requirement will be identified in the contract.

(c) If the Level 1 SSHO has to temporarily (that is, up to 24 hours / one day) leave the site of work due to unforeseen or emergency situations, a Level 1, 2, or 3 SSHO may be used in the interim and must be on the site of work at all times when work is being performed.

(d) If the Level 1 SSHO must be off-site for a period longer than 24 hours / one day, an additional/alternate Level 1 SSHO must be at the site of work to fulfill the same roles and responsibilities when work is performed.

(e) If an activity, task or DFOV contains multiple sites and has been assessed and given an activity residual RAC of low or medium, any Level SSHO may be appointed for each site where remote work locations are more than 45 minutes travel time from the primary Level 1 SSHO's site of work.

(f) A Level 1 SSHO must be assigned and at the site of work at all projects that have a residual RAC of high or extremely high. A Level 2 or 3 SSHO cannot be assigned to projects that have a residual RAC of high or extremely high.

(3) Exceptions to a full time Level 1 SSHO Requirement. The full time Level 1 SSHO requirement may be modified to use any level SSHO or combination of levels by the USACE KO and the local SOHO in contract documents according to the exemptions in this chapter. Modification of the requirement must be a collaborative effort and will be based on job complexity, size, and other pertinent factors. The KO and the SOHO will document the decision and rationale used to modify the requirements based on the project scope and risk. Some examples of contracts that may qualify for exceptions include):

(a) Tasks with no exposure to mechanical or explosive hazards such as field walk-over, surface soil sampling, or long-term sampling.

(b) Dredging, Maintenance, Service, and Limited Scope Contracts. These contracts include work such as dredging, mowing, furniture installation, fuel system maintenance, park attendants, and rest room cleaning.

c. Contractor SOH Submittals. (2-8.c)

(1) All submittals must be submitted according to the requirements of the contract.

(2) Submittals must be reviewed and approved by the contractor prior to submission to the government to ensure minimum contractual requirements are being met.

(3) The USACE KO or COR must review and accept contractor SOH submittals (for example, APP, AHA, proof of qualification) prior to work. This review is a cursory review intended to determine if SOH submittals generally conform to the SOH contractual requirements. If they do, the KO or COR will accept the submittal. If SOH

submittals do not conform to SOH contractual requirements, they will be returned to the contractor for correction.

Note. Acceptance of these submittals in no way relieves the contractor from ensuring employees a safe and healthful work environment or from complying the contract, this manual, applicable federal, state, local requirements, and good engineering practices.

d. Accident Investigation and Reporting. The reporting and associated investigation of accidents and near misses is considered a leading indicator. Utilize the ENG Form 3394 (add form title in parentheses) to report accidents and near misses. (2-8.d)

(1) Contractors must investigate, analyze, and report all accidents and near misses occurring incidentally to an operation, project, or facility for which this manual is applicable according to table 2-1.

Note. Except for rescue and emergency measures, do not disturb the accident scene until it has been released by the investigating official.

(2) Notify OSHA, as applicable, according to 29 CFR 1904.39.

(3) Notify the USCG if the work-related injury is considered a marine casualty or a vessel is involved in a marine casualty according to 46 CFR 4.05-5 and 4.05-10, a commercial diving casualty under 46 CFR 197.484.

(4) First aid treatments do not require an ENG Form 3394 unless requested by the KO or COR. Maintain records of all first aid treatments and provide them to the KO or COR upon request.

(5) Records must include, at a minimum, employee's name, job title, date, and type of accident, causes and corrective actions taken (for example, AHA review, process changes, establishment of controls, personnel qualifications, and training).

(6) The SSHO and/or SOHO will review and analyze this data for corrective actions, as appropriate.

e. Physical Qualifications of Employees. (2-8.e)

(1) All persons must be physically and medically qualified for performing the duties they are assigned. Some factors to be considered in making work assignments are strength, endurance, agility, coordination, and visual and hearing acuity.

(2) At a minimum, employees must meet the physical requirements for specific job tasks and hazards as required by this manual, the position, the job description, OSHA guidelines, applicable DOT regulations or applicable USCG requirements.

(3) Record medical documentation using applicable medical screening and medical history and examination forms and maintain them according to 5 CFR 293.

(4) While on duty, employees must not use or be under the influence of alcohol, narcotics, intoxicants, or similar performance or mind-altering substances. Employers must enforce the drug-free workplace requirements. Employees found to be under the influence of or consuming such substances will be immediately removed from the site of work.

(5) Any employee under a physician's treatment and taking prescribed narcotics or any medication that may prevent them being ready, willing, and able to safely perform position duties, must provide a medical clearance statement to their supervisor.

f. SOH Communications. (2-8.f)

(1) Communicate all SOH program information, documents, signs, and tags to employees in a language that they understand. Work sites with non-English speaking employees must have onsite interpreters and translators that are fluent in all the spoken language(s).

(2) SOH Bulletin Board. Within seven calendar days after commencement of contract work, the contractor must erect a safety bulletin board at the site of work. Where site, duration, or logistics of a project do not facilitate a bulletin board, an alternative KO or COR accepted method (for example, binder, digital) may be deemed as meeting the requirement for a bulletin board. The alternative method must include all mandatory information for employee and visitor review, as follows):

- (a) A map denoting the route to the nearest emergency care facility.
- (b) Emergency phone numbers.
- (c) A copy of the most current APP on or adjacent to the bulletin board or post a notice on the bulletin board stating the location of the plan. Locate the plan at the site of work and make it accessible to all employees.
- (d) Post OSHA Form 300A from February 1 to April 30 of the year following the issuance of this form (see <https://www.osha.gov/recordkeeping/forms>). Mount it on or adjacent to the bulletin board and make it accessible to all employees. See 29 CFR 1904, in OSHA's recordkeeping rule, for further details on the access provisions for these forms.
- (e) Mount a copy of the SOH deficiency tracking log on or adjacent to the bulletin board or post a notice on the bulletin board stating the location where it may be accessed by all employees upon request.
- (f) SOH promotional posters.

(g) OSHA Safety and Health Poster.

(h) A copy of the hazardous material inventory, identification of use, approximate quantities, and a site map detailing location as required by this manual.

(3) Deficiency Log and Hazard Tracking System. The contractor must establish a SOH deficiency tracking system that lists and monitors the status of SOH deficiencies in chronological order. The tracking system provides useful information that must be used to evaluate the effectiveness of the APP. A monthly evaluation of the data should be discussed in the QC or SOH meeting with everyone on the project. The deficiency log must be posted on the SOH bulletin board or post a notice on the bulletin board stating its location. The log must contain the following:

- (a) Date deficiency identified.
- (b) Description of deficiency.
- (c) Name of person responsible for correcting deficiency.
- (d) Projected resolution date.
- (e) Date resolved.

(4) Safety Meetings. Safety meetings must be conducted on project sites to review past activities, plan for new or changed operations, review pertinent aspects of appropriate AHAs, establish safe working procedures for anticipated hazards, and provide pertinent SOH training and motivation)

(a) Meetings must be conducted at least once a month for all supervisors on the project location and at least once a week for all workers.

(b) Document the meetings. Include the date, persons in attendance, subjects discussed, and names of individual(s) who conducted the meeting. Maintain the documentation and furnish copies to the KO or COR on request.

(c) Contractors will invite the KO or COR to all scheduled meetings providing sufficient advanced notification.

(5) Signage. Post signs at all site entrances requiring anyone entering the site to report to the project office for a safety briefing.

g. Interpretations. The following process will be used for contractors requesting interpretation of a requirement contained in this manual. (2-8.g)

- (1) The prime contractor must officially submit the following:
 - (a) Specifically identify the requirement for information/interpretation.
 - (b) Provide the exact citation and quote the requirement in question. A separate request must be made for each requirement.
 - (c) State the source of confusion regarding the requirement.
 - (d) Provide all the information necessary to understand the context in which the requirement is being applied.
 - (e) Provide the information/interpretation of the requirement and rationale.

(2) A contractor must request interpretation of a requirement from the field office under which they work who will then coordinate with the local SOHO to provide a response. The local USACE SOHO must submit the official request for information/interpretation to the HQUSACE-SO SharePoint located at https://team.usace.army.mil/sites/HQ/SO/Pages/Variations_and_Waivers.aspx within five business days of receipt.

(3) The entire package containing the requester's information, the local SOHO's interpretation, rationale, and supporting information in the HQUSACE-SO SharePoint will be sent to the division SOHO who must render a response within five business days of receipt in the system, and HQUSACE-SO will have at least 15 business days from date of receipt to consider the request and to render a written decision from the Chief of Safety and Occupational Health, HQUSACE.

Note. Interpretations apply ONLY to the specific time and the context in which the requirement is being applied. They may not be used as precedents to determine future applications of the requirement. HQUSACE-SO will make the proper notifications if a request for information/interpretation may be applied globally.

(4) Unofficial requests for interpretations to include clarifications of requirements from local SOHOs may be made via email or telephone. However, the answers provided via this mode will be considered general guidance, not official information/interpretations.

(5) HQUSACE-SO will NOT accept requests for official information/interpretations from parties outside the USACE structure.

h. Variations and Waivers. Within the Corps of Engineers, variations and waivers to provisions of this manual require the approval of the Chief of Safety and Occupational Health, HQUSACE. Variations or waivers must provide an equal or greater level of protection, must be substantiated with a hazard analysis of the activity and must be

documented and forwarded through channels to Chief of Safety and Occupational Health, HQUSACE. (2-8.h)

(1) The following process must be used when requesting a waiver or variance from a requirement contained in this manual:

(a) Official requests for variances and waivers and all responses must be submitted through the local USACE SOHO, who will enter the request in the HQUSACE-SO SharePoint.

(b) The local SOHO must submit, render a concurrence or non-concurrence, and justification within five business days.

(2) Waiver/Variance request package must be complete and must include the following:

(a) Specific identity of the requirement for which relief is being sought, providing exact citation and quoting the requirement;

(b) Statement as to whether a waiver (total elimination of the requirement) or a variance (retaining the basic requirement, but doing it differently) is being sought;

(c) Details as to why it is not possible or practical to comply with the requirement;

(d) All the information (maps, drawings, references, calculations, change analysis or impact, etc.) necessary to make an informed decision. The burden of proof rests with the requester. Failure to provide the necessary information may be justification for denial of the request. It is up to the requester to make the case as to why the requirement should be waived or varied;

(e) Identification of specific time period and operation for which the request is being made. A waiver/variance will be granted for specific time periods and operations and may not be used as a defense for failure to comply with a requirement at another time or on another project;

(f) Explanation of method they plan to use in lieu of the requirement and how it provides protection equal to or greater than the requirement being challenged;

(g) A detailed AHA addressing the alternate procedure. Risk assessment should be a part of the AHA process;

(h) Provision of any other requirements or standards addressing the requirement in question. It is incumbent upon the requester to research the literature to determine if any other requirement or standard exists addressing the requirement from which relief is being sought. If there is another standard(s), the requester must identify it and provide

a copy. Requests for waivers/variances will not be processed until this requirement has been met.

(3) Requester must work the action with the local USACE SOHO.

2-9. Figures and Tables.

**Table 2-1
Accident Reporting Required Timeline**

Accident Type	Notify <u>KO or COR</u>	Complete Final Accident Report on ENG 3394 and provide to <u>KO or COR</u>
Fatality, in-patient hospitalization, amputation, eye loss, or property damage over \$600,000.	Immediately, no later than (NLT) 8 Hours	Within 7 Days
All other accidents and near misses.	Immediately NLT 24 Hours	Within 7 Days

2-10. Checklists and Forms.

a. ENG 3394, U.S. Army Corps of Engineers Mishap Notification and Investigation (<https://www.publications.usace.army.mil/USACE-Publications/Engineer-Forms/>) (2-10.a)

b. ENG Form 6206, Activity Hazard Analysis (AHA) (non-mandatory) (<https://www.publications.usace.army.mil/LinkClick.aspx?fileticket=K66no-4L-v4%3d&tabid=16438&portalid=76&mid=43543>) (2-10.b)

c. ENG Form 6282, Site Safety and Health Officer (SSHO) Designation Letter (mandatory) (<https://www.publications.usace.army.mil/LinkClick.aspx?fileticket=6rKomvrleBI%3d&tabid=16438&portalid=76&mid=43543>) (2-10.c)

d. ENG Form 6293, Accident Prevention Plan (APP) Worksheet (mandatory) (https://www.publications.usace.army.mil/LinkClick.aspx?fileticket=LmW_eJDoLpl%3d&tabid=16438&portalid=76&mid=43543) (2-10.d)

**Chapter 3
Medical and First Aid**

3-1. References.

a. ANSI/International Safety Equipment Association (ISEA) Z308.1, Minimum Requirements for Workplace First Aid Kits and Supplies (<https://webstore.ansi.org/>) (3-1.a)

b. Centers for Disease Control and Prevention (CDC), Travelers Health (<https://wwwnc.cdc.gov/travel>) (3-1.b)

c. Defense Centers for Public Health – Aberdeen (<https://phc.amedd.army.mil/Pages/default.aspx>) (3-1.c)

d. Department of Health and Human Services, General Services Administration, “Guidelines for Public Access Defibrillation Programs in Federal Facilities,” Federal Register (FR), Volume 74, Number 156, p.4113-41139 (August 14, 2009) (https://foh.psc.gov/services/aed/fmr_bulletin_09-b2-guidelines_public_access_defib_in_federal_facilities.pdf#:~:text=SUMMARY%3A%20n%20May%2023%2C%202001%2C%20the%20Department%20of,sponsoring%20the%20program%20and%20not%20GSA%20or%20HHS) (3-1.d)

e. OSHA 3317-06N 2006, OSHA Best Practices Guide, Fundamentals of a Workplace First Aid Program (<https://www.osha.gov/sites/default/files/publications/OSHA3317first-aid.pdf>) (3-1.e)

f. 29 CFR 825.125, Definition of Health Care Provider (<https://www.govinfo.gov/content/pkg/CFR-2022-title29-vol3/pdf/CFR-2022-title29-vol3-sec825-125.pdf>) (3-1.f)

g. 29 CFR 1910.151, Medical Services and First Aid (<https://www.govinfo.gov/content/pkg/CFR-2019-title29-vol5/pdf/CFR-2019-title29-vol5-sec1910-151.pdf>) (3-1.g)

h. 29 CFR 1910.1030, Bloodborne Pathogens (<https://www.govinfo.gov/content/pkg/CFR-2019-title29-vol6/pdf/CFR-2019-title29-vol6-sec1910-1030.pdf>) (3-1.h)

i. 29 CFR 1926.50, Medical Services and First Aid (<https://www.govinfo.gov/content/pkg/CFR-2019-title29-vol8/pdf/CFR-2019-title29-vol8-sec1926-50.pdf>) (3-1.i)

3-2. Definitions.

a. First Aid Attendant. First Aid Attendants provide first aid and medical attention that is usually administered immediately after the injury occurs and at the location where it occurred. It often consists of a one-time, short-term treatment and requires little technology or training to administer. First aid can include cleaning minor cuts, scrapes, or scratches; treating a minor burn; applying bandages and dressings; the use of non-prescription medicine; draining blisters; removing debris from the eyes; massage; and drinking fluids to relieve heat stress. First Aid attendants will use the OSHA Best Practices Guide, Fundamentals of a Workplace First Aid Program OSHA 3317-06N 2006. (3-2.a)

b. Health Care Provider. A Health Care Provider is: (3-2.b)

(1) A doctor of medicine or osteopathy who is authorized to practice medicine or surgery (as appropriate) by the state in which the doctor practices; or

Note. State means any state of the United States or the District of Columbia or any Territory or possession of the United States.

Note. The phrase authorized to practice in the state as used means that the provider must be authorized to diagnose and treat physical or mental health conditions.

(2) Any other person determined by the Secretary of Labor or authorized representative to be capable of providing health care services. Including but not limited to (See 29 CFR 825.125 for other health care services providers):

(a) Podiatrists, dentists, clinical psychologists, optometrists, and chiropractors (limited to treatment consisting of manual manipulation of the spine to correct a subluxation as demonstrated by X-ray to exist) authorized to practice in the state and performing within the scope of their practice as defined under state law.

(b) Nurse practitioners, nurse-midwives, clinical social workers, and physician assistants who are authorized to practice under state law and who are performing within the scope of their practice as defined under state law.

Note. A health care provider listed above who practices in a country other than the United States, who is authorized to practice according to the law of that country, and who is performing within the scope of his or her practice as defined under such law is capable of providing health care services.

c. First Aid Station. The place at an event where people can go for medical treatment if they become ill or are injured. (3-2.c)

d. Other Potentially Infectious Materials. Human body fluids (that is, semen, vaginal secretions, cerebrospinal fluid, synovial fluid, pleural fluid, pericardial fluid, peritoneal fluid, amniotic fluid), any body fluid that is visibly contaminated with blood, and all body fluids where it is difficult or impossible to differentiate or identify; unfixed human tissues or organs; and human immunodeficiency virus (HIV)-containing cell or tissue cultures, organ cultures, and HIV- or hepatitis B virus (HBV)-containing culture medium or other solutions, or blood, organs, or other tissues infected with HIV or HBV. (3-2.d)

e. Near Proximity. Emergency care must be available within no more than 3-4 minutes from the workplace. (3-2.e)

3-3. Personnel Required Qualification/Training.

Based on the work activities performed, there may be other situations in the workplace that require additional personnel required training/qualifications in these areas identified in the applicable chapters (for example, chapters 6, 9, 11, 30, 19).

a. First Aid and Cardiopulmonary Resuscitation (CPR). First aid attendants must hold current certification in first aid and CPR from the American Red Cross, the American Heart Association, an organization whose training adheres to the standards of the International Liaison Committee on Resuscitation (as stated in writing), or a Health Care Provider. (3-3.a)

(1) All classes must include a hands-on component that cannot be taken online.

(2) The certificate(s) must state the date of issue and expiration date.

(3) Persons must be retrained every two years to maintain certification.

b. Automatic External Defibrillator (AED). When AEDs are present in the workplace, persons who are responsible for using them must be trained according to paragraph 3-3.a. (3-3.b)

c. First Aid Kit. All employees who work where there is a first aid kit must be trained on the content and use of the kit supplies. (3-3.c)

d. Bloodborne Pathogens (BBP). Instruct employees that may be exposed to blood or other potentially infectious materials through the performance of their job duties according to 29 CFR 1910.1030. (3-3.d)

e. First Aid Attendants. First aid attendants will provide first aid according to OSHA's first aid definition <https://www.osha.gov/medical-first-aid/recognition>. (3-3.e)

f. Health Care Provider. All projects, activities, or contracts (USACE or contractor) where work or tasks with a high or extremely high residual RAC and which 1,000 persons or more are employed (greatest total number of employees on a shift) must employ the full-time services of a Health Care Provider. (3-3.f)

Note. A certified Nationally Registered Emergency Medical Technician Basic/Intermediate/Advanced/Paramedic, Licensed Practical Nurse (LPN) or Registered Nurse (RN), who has direct communication with a Health Care Provider, when allowed and required by state law, may be used when a full-time Health Care Provider is not available. Military personnel with equivalent qualifications and certifications may be used in lieu of these personnel.

3-4. Roles and Responsibilities.

Not Applicable.

3-5. Inspection Requirements.

a. First Aid Kits. Check the contents of first aid kits prior to their use onsite and at least every 3 months when work is in progress. Ensure that they are complete, in good condition, and have not expired. (3-5.a)

b. Automatic External Defibrillator (AED). Document battery and functionality checks at least monthly or according to the manufacturer's instructions, or applicable federal, state, or local requirements, whichever is more stringent. (3-5.b)

3-6. Activity Hazard Analysis (AHA) Requirements.

Develop AHAs according to paragraphs 1-6 or 2-6, as applicable.

3-7. Minimum Plan Requirements.

a. Site-Specific Exposure Control Plan. A written site-specific Exposure Control Plan is required when employees may be exposed to blood or other potentially infectious materials through the performance of their job duties. When required, develop a site-specific Exposure Control Plan according to 29 CFR 1910.1030 to include the following: (3-7.a)

(1) Detailed description of work activities performed and/or job classifications in which employees may be exposed to blood or other potentially infectious materials.

(2) Description of anticipated hazards or concerns and the control measures that will be implemented to control to an acceptable level (for example, universal precautions, engineering and administrative controls, PPE, housekeeping, hepatitis B vaccination, training, and labels and signs).

(3) Post Exposure Control Protocol to manage the immediate medical evaluation of individuals involved in potentially infectious exposures, as recommended by the CDC. The plan must address at least HIV, HBV, hepatitis C virus (HCV), and any other disease state identified by the CDC. Follow applicable tribal, local, state, federal, and Host Nation standards for infectious diseases.

(4) Recordkeeping procedures.

(5) Inspection and oversight methods to ensure adherence to the plan and that the plan is up to date. The plan must be reviewed and updated at least annually or whenever necessary to address new or modified work activities in which employees may be exposed to blood or other potentially infectious materials.

b. AED Program. A written AED Program is required when AEDs are present in the workplace for employee use. The AED Program must include at least the following: (3-7.b)

(1) Training and Retraining (see para 3-3). Appropriate licensed Health Care Provider programmatic involvement and oversight according to Food and Drug Administration (FDA) and/or state guidance.

(2) Inspection Requirements. AEDs are required to be inspected and there must be a documented process for regular inspections within the program according to paragraph 3-5.b.

(3) SOPs for placement, maintenance and inspection of AEDs and emergency medical service (EMS) activation.

(4) Equipment Maintenance Program based on the manufacturer's recommendations that, at a minimum, include pad (regular and after use) and battery replacement.

3-8. General Requirements.

a. General. Contractors and all USACE locations must arrange for medical facilities and personnel to provide prompt attention to injured employees before starting work. Inform the medical facilities and personnel expected to treat injured employees of the nature of the work to be performed and the injuries and illnesses prevalent on such jobsites. Depending on the scope and size of the job, the USACE supervisor/KO or COR may require a formal written agreement. For work or tasks with a high or extremely high residual RAC, confirm in writing the arrangements with the medical facility. See chapter 1 or 2, as applicable. (3-8.a)

(1) Provide all employees with an effective means of communication that is readily available (for example, hard-wired, cellular telephone, or two-way radio) to dial 911 or other emergency response access. Test the communication devices in the area of use to assure functionality.

(2) Provide an effective means of transportation for immediate care of injured workers.

(3) Post the telephone numbers of physicians, hospitals, or ambulances on the safety bulletin board, near the onsite project office telephones, and at other conspicuous locations.

(4) Prepare a highly visible map delineating the best route to the nearest medical facility and post it on the safety bulletin board (see chapter 1 or 2).

b. First Aid and CPR Availability. (3-8.b)

(1) For shifts with more than one (1) employee, provide at least two employees that are certified to administer first aid and CPR (see para 3-3).

(2) When employees work alone, they must be certified in first aid and be provided an effective means of communication to call for assistance in the event of an emergency.

(3) When an employee(s) work in remote areas, or in areas where it is not reasonably accessible by time or distance for first aid, they too will be certified in first aid and be provided an effective means of communication to call for assistance in the event of an emergency.

(4) For jobsites with more than 100 employees on one shift, maintain a list of certified individuals in the site office and provide to site security personnel, as applicable.

c. First Aid Kits. (3-8.c)

(1) First aid kits must meet ANSI Z308.1 and contain the minimum fill requirements in table 3-1.

(2) Provide at least one first aid kit for every 25 (or fewer) employees.

(3) In addition to the basic fill requirements of the first aid kit, the contractor or local USACE SOHO, in consultation with a health care professional, must evaluate the hazards found in the work environment to determine the necessity of additional fill contents.

(4) Base the performance requirements for the first aid kits on the location where they will be stored according to ANSI Z308.1.

(a) Type I kits are intended for use in stationary, indoor settings where the potential for damage of kit supplies due to environmental factors and rough handling is minimal.

(b) Type II kits are for portable indoor settings where the potential for damage of kit supplies due to environmental factors and rough handling is minimal.

(c) Type III kits are for portable use in mobile, indoor and/or outdoor settings where the potential for damage of kit supplies due to environmental factors is not probable (for example, general indoor, sheltered outdoor use).

(d) Type IV kits are intended for portable use in mobile industries (that is, utilities, construction, transportation, armed forces) and/or outdoor settings where the potential for damage of kit supplies due to environmental factors and rough handling is significant.

(5) Clearly mark and distribute first aid kits through the site so that they are easily accessible to all workers and protected from the weather. The individual contents of the first aid kits must be kept sterile.

(6) Inspect first aid kits according to paragraph 3-5.

(7) All employees who work where there is a first aid kit must be trained according to paragraph 3-3.

d. Automatic External Defibrillators (AED). The placement of AEDs is optional, (except for health clinics) but highly recommended. Perform an assessment of the time and distance to EMS and provide a justification for the AEDs before placing them on the work site. When AEDs are present in the workplace for employee use, an AED Program must be developed (see para 3-7.b). For the ease of use and program maintenance, all AEDs in a location and/or Command must be the same manufacturer and model. For guidance, USACE facilities should refer to “Guidelines for Public Access Defibrillation Programs in Federal Facilities.” (3-8.d)

e. First Aid and Medical Facility Requirements. (3-8.e)

(1) Provide a first aid kit(s) according to paragraph 3-8.c for all projects, activities, or contracts (USACE or contractor operated) where:

(a) Less than 100 persons are employed (greatest total number of employees on a shift) and a first aid station nor a health clinic is available, or

(b) The site is not in near proximity from a hospital, medical clinic, or doctors’ office which has coordinated to provide emergency medical support.

(2) First Aid Stations.

(a) Establish and equip a first aid station at all projects, activities, or contracts (USACE or contractor operated) where between 100 and 299 persons are employed (greatest total number of employees on a shift) at the site of the work. In non-rural locations where at least two employees per shift are CPR certified (see para 3-3.a) and a first aid kit is available (see para 3-8.c), a first aid station is not required. In this case, emergency medical support must be provided by a medical clinic, hospital, or doctor’s office that is in near proximity of the work location, and that is capable of and has coordinated to provide emergency medical support.

(b) Where tunnels are being excavated, provide a first aid station and transportation so that treatment is readily available and in near proximity.

(c) A certified first aid attendant must be on duty in the first aid stations at all hours when work is in progress (except when on emergency calls) (see para 3-3.a).

(3) Health Clinics.

(a) All medium, high, or extremely high-risk operations, projects, activities, or contracts (USACE or contractor operated) for which 300 or more persons are employed at work (greatest total number of employees on a shift), must establish and equip, as directed by a Health Care Provider, a health clinic.

(b) Health Clinics must provide privacy, adequate lighting, climate control, adequate toilet facilities, hot and cold water, drainage, and electrical outlets. Walls and ceilings must be finished with the equivalent of two coats of white paint, windows and doors must be screened, and floors must be constructed with impervious materials.

(c) In remote locations where a health clinic is required, but where medical care is not available in near proximity, provide a properly equipped emergency vehicle, helicopter, or mobile first aid unit during work. The emergency vehicles may not be used for any other purpose, except in the case of a helicopter, which may be used for shift crew changes.

(d) An RN, a certified Emergency Medical Technician, Intermediate/Paramedic, or an LPN, with Health Care Provider oversight when allowed and required by state law, must be assigned on a full-time basis to each installation requiring a health clinic.

(e) Health clinics must be equipped with an AED.

(4) For activities requiring a first aid station or a health clinic, determine the type of facilities and equipment that will be provided after considering the proximity and quality of available medical services. The layout and operation of the facilities and equipment must follow the recommendations of a Health Care Provider. Alternative facilities that provide the quantity and quality of services outlined in this chapter may be used if recommended by the consulting Health Care Provider.

(5) Denote the location of first aid stations and health clinics with identification and directional markers.

(6) Provide emergency lighting for all first aid stations and health clinics.

(7) All locations where the work efforts are primarily administrative, such as a district or regulatory office, must have either an accessible, staffed infirmary in the building or a medical clinic, hospital, or doctors' office that is accessible within 15 minutes and that is capable of and has coordinated to provide emergency medical support. If an outside emergency medical clinic, hospital, or doctor's office is used, the facility must be equipped with a first aid kit(s) that meets ANSI Z308.1 and have a minimum of two employees on each shift certified to administer first aid and CPR. (See paras 3-3.a and 3-8.c)

f. Drenching and Flushing Facilities. When work activities present potential exposure (of any part of the body) to toxic or corrosive materials, provide drenching and/or flushing facilities in the work area for immediate emergency use. (See chapter 6) (3-8.f)

g. Bloodborne Pathogens (BBP). This paragraph applies when employees may be exposed to blood or other potentially infectious materials through the performance of their job duties. This includes but is not limited to employees designated as responsible

for rendering first aid or medical assistance. In addition to the below, also follow 29 CFR 1910.1030. (3-8.g)

(1) Provide employees with and ensure use and maintenance of PPE (for example, breathing barrier, latex-free gloves, gowns, masks, eye protectors, and/or resuscitation equipment) when appropriate for rendering first aid or other medical assistance to prevent contact with blood or other potentially infectious materials.

(2) Establish a site-specific Exposure Control Plan according to paragraph 3-7.

(3) Train the necessary employees according to paragraph 3-3.

h. Biologic and Environmental Diseases. Prior to the start of work outside the employee's normal geographical area, inform employees of parasitic, bacterial, viral, and environmental diseases endemic to the geographical work location (for example, Lyme Disease, West Nile Virus, Hantavirus, Histoplasmosis, Rocky-Mountain Spotted Fever, Dengue Fever, Malaria). (3-8.h)

(1) Seek guidance on the potential biological and environmental diseases in the work location. Consult the CDC Traveler's Health webpage, [Defense Centers for Public Health – Aberdeen](#), and the local health department.

(2) Provide the following information to the employee traveling in areas where such diseases are endemic:

(a) Modes of disease transmission.

(b) Specific health risks associated with the disease.

(c) Preventive measures such as available vaccines and PPE (for example, gloves, eye and skin protection, respirator).

(d) Appropriate work practices to prevent contact with infected agents (for example, bird or rodent droppings), such as watering down areas prior to dust-generating activities.

(e) Vaccine information, to include information on the effectiveness, risk, and availability.

(f) Safe removal of the source, where applicable.

(g) Symptom recognition and medical referral.

3-9. Figures and Tables.

**Table 3-1
Requirements for Basic First Aid Unit Package**

Unit First Aid Item	Minimum Size or Volume (Metric)	Minimum Size or Volume (US)	Item Quantity per Unit Package	Unit Package Size
Adhesive Bandage	2.5 x 7.5 cm	1 x 3 inches	<u>50</u>	1
Adhesive Tape	2.3 m	2.5 yd (total)	2	1 or 2
<u>Antibiotic Application</u>	<u>0.5 g</u>	<u>1/57 oz</u>	<u>25</u>	<u>1</u>
Antiseptic Wipe	2.5 x 2.5 cm	1 x 1 inch	<u>50</u>	1
Aspirin, Individually Wrapped	325 mg	Not Applicable	2	2
Burn Dressing (Gel)	10 x 10 cm	4 x 4 inches	<u>2</u>	1-2
Burn Treatment	0.9 g	1/32 oz	<u>25</u>	1
Cold Pack	10 x 12.5 cm	4 x 5 inches	<u>2</u>	1
Tourniquet	<u>2.5 cm width</u>	<u>1 in width</u>	1	1
Breathing Barrier	Not Applicable	Not Applicable	1	1
Eye Covering, with means of attachment	19 cm ²	2.9 in ²	2	1
Eye/Skin Wash	118 ml (total)	4 fl. oz total	1	2
First Aid Guide	Not Applicable	Not Applicable	1	1
<u>Medical Exam Gloves, latex free</u>	XL	XL	<u>4 pair</u>	1
Hand Sanitizer	0.9 g	1/32 oz	<u>10</u>	1
Roller Bandage (2 inches)	5 x 366 cm	2 inches x 4 yd	2	1
Roller Bandage (4 inches)	10 x 366 cm	4 inches x 4 yd	1	1
<u>Scissors</u>	Not Applicable	Not Applicable	<u>1</u>	<u>1</u>
<u>Splint (Padded)</u>	<u>10.2 x 61 cm</u>	<u>4 x 24 inches</u>	<u>1</u>	<u>1</u>
Sterile pads	7.5 x 7.5 cm	3 x 3 inches	4	1
<u>Trauma Pads</u>	<u>12.7 x 2.9 cm</u>	<u>5 x 9 inches</u>	<u>4</u>	<u>1</u>
Triangular Bandage	101 x 101 x 142 cm	40 x 40 x 56 inches	<u>2</u>	1

3-10. Checklists and Forms.

Not Applicable.

Chapter 4 Temporary Facilities

4-1. References.

- a. American Society of Civil Engineers (ASCE) 7, Minimum Design Loads and Associated Criteria for Buildings and Other Structures (<https://ascelibrary.org/standards>) (4-1.a)
- b. Department of Transportation (DOT) Federal Highway Administration's "Manual on Uniform Traffic Control Devices" (MUTCD) (<https://mutcd.fhwa.dot.gov>) (4-1.b)
- c. EM 385-1-97, Explosives Safety and Health Requirements Manual (<https://www.publications.usace.army.mil/USACE-Publications/Engineer-Manuals/>) (4-1.c)
- d. National Fire Protection Association (NFPA) 101, Life Safety Code (<https://www.nfpa.org/Codes-and-Standards>) (4-1.d)
- e. 29 CFR 1910.142, Temporary Labor Camps (<https://www.govinfo.gov/content/pkg/CFR-2020-title29-vol5/pdf/CFR-2020-title29-vol5-sec1910-142.pdf>) (4-1.e)

4-2. Definitions.

- a. Access/Haul Road. A temporary road constructed for the principal purpose of movement of construction materials, construction machinery, and/or access to a construction site. (4-2.a)
- b. Barricade. A physical obstruction (for example, tape, screens, cones) intended to warn of and limit access to a hazardous area. (4-2.b)
- c. Percent Grade. Equal to the number of feet that the roadway vertically inclines or declines over a horizontal distance of 100 feet (30.5 m). For example, a 10 percent grade means the roadway vertically rises or drops 10 feet (3 m) for every 100 feet (30.5 m) traveled. (4-2.c)

4-3. Personnel Required Training/Qualification.

Not Applicable.

4-4. Roles and Responsibilities.

Not Applicable.

4-5. Inspection Requirements.

Not Applicable.

4-6. Activity Hazard Analysis (AHA) Requirements.

Develop AHAs according to paragraphs 1-6 or 2-6, as applicable.

4-7. Minimum Plan Requirements.

a. Construction Site Plan. A written Construction Site Plan is required when temporary facilities are used and must include the following: (4-7.a)

(1) Locations and dimensions of temporary buildings and facilities to include layouts and details.

(2) Details on required anchoring of temporary structures.

(3) Equipment and material storage areas.

(4) Details of fencing to include ingress/egress points and signage used to secure the site.

(5) Access routes, see paragraphs 4-7.b and 4-8.e for access and haul road requirements.

(6) Location of containers for trash and recycling of materials.

(7) Temporary sanitary facilities.

(8) Parking areas for crews.

Note. See chapter 35 for sanitation, chapter 9 for temporary building spacing requirements, chapter 11 for temporary power distribution approval requirements, and chapter 24 for temporary ramp, trestle, scaffold, and platform approval requirements.

b. Access/Haul Road Plan. A written Access/Haul Road Plan is required when access or haul roads are to be used. Design access and haul roads according to current engineering criteria. Work on the haul road must not commence until the USACE supervisor/KO or COR has accepted the plan. The plan must address the following items: (4-7.b)

(1) Equipment usage, traffic density and patterns, right-of-way rules, and hours of operation.

(2) Road layout and widths, horizontal and vertical curve data, and sight distances.

(3) Sign and flagger requirements, road markings, and traffic control devices.

(4) Drainage controls.

(5) Safety controls (for example, barricades) in areas where construction vehicles and the public may come in contact.

(6) Maintenance requirements, including roadway integrity (for example, roughness, ruts, washout, smoothness) and dust control.

(7) Hazards adjacent to the road (for example, bodies of water, steep embankments).

4-8. General Requirements.

a. Temporary Structures. (4-8.a)

(1) Design and construct temporary structures according to ASCE 7. Consider the following loadings:

(a) Dead and live loads.

(b) Soil and hydrostatic pressures.

(c) Wind loads.

(d) Rain and snow loads.

(e) Flood and ice loads.

(f) Seismic forces.

(2) Anchor trailers and other temporary structures used as field offices, personnel housing, or for storage with rods and cables or by steel straps to ground anchors. Design the anchor system to withstand winds and according to the applicable state or local standards for anchoring mobile trailer homes.

(3) Control the growth of tall grass, brush, and weeds adjacent to trailers and other temporary structures used as field offices, personnel housing, or storage.

(4) Properly bond and ground temporary structures, equipment, and fencing placed under or near overhead electrical power transmission and distribution lines (see chapter 11).

b. Fencing and Warning Signs. (4-8.b)

(1) Provide temporary project fencing, or a substitute approved by the USACE supervisor or accepted by the KO or COR and delineated in the Construction Site Plan, on all projects located in areas of active use by members of the public. This includes sites near family housing areas or school facilities.

(2) Fencing must extend from grade to a minimum of 4 feet (1.2 m) above grade and must have a maximum mesh size of 2 inches (5 cm). Fencing must remain rigid and taut (that is, less than 4 inches (10 cm) of deflection when a minimum of 200 pounds (0.9 kilonewtons (kN) of force is exerted on it from any direction).

(3) Post signs on the fencing warning of the presence of construction hazards and for unauthorized persons to keep out of the construction area. At minimum, post signs every 150 feet (45.7 m). Post at least one warning sign on the fenced sides of project sites that are less than 150 feet (45.7 m) long. (See chapter 8)

(4) Depending upon the nature and location of the project site, the USACE supervisor/KO or COR may determine that fencing is not required. Perform a risk analysis of public exposure and project-specific considerations to make this determination and include the results in the Construction Site Plan. In those locations where the USACE supervisor/KO or COR has determined fencing is not needed, conspicuously post warning signs that identify the construction hazards.

c. Temporary Work Camps (Floating Plant Excluded). Design and construct work and labor camps according to 29 CFR 1910.142 and NFPA 101. (4-8.c)

(1) Provide shelters for protection from the elements. Each room used for sleeping purposes must contain at least 55 ft² (5.1 m²) of floor space for each employee currently remaining onsite during off duty hours, without regard to shift work, and at least 7 feet-6 inch (2.3 m) ceilings. The floor space does not include areas occupied by closets or wall lockers.

(2) Elevate all wooden floors not less than 1.5 feet (0.5 m) above the ground level at all points to prevent dampness and permit free circulation of air beneath and for easier and safer maintenance.

(3) Temporary sleeping quarters must be heated, cooled, ventilated, lighted, and kept in a clean and safe condition.

d. Temporary Explosives Storage Areas. Store explosives in temporary explosives storage areas according to EM 385-1-97. (4-8.d)

e. Access/Haul Roads. Prior to construction or use of an access/haul road, a written Access/Haul Road Plan must be developed according to paragraph 4-7. (4-8.e)

(1) Do not move any equipment or vehicle upon an access or haul road unless the roadway is constructed and maintained to safely accommodate the movement of the equipment or vehicle involved and has been approved by the USACE supervisor or accepted by the KO or COR.

(2) When road levels are above working levels, construct berms, barricades, or curbs to prevent vehicles overrunning the edge or end of embankment. The height of

the berms and curbs must be at least one-half the diameter of the tires on the largest piece of equipment using the roadway.

(3) Roadways must have a crown and ditches for drainage. Intercept water runoff before it reaches a switch back or large fill area and drain it away from these areas in a suitable manner (for example, culvert).

(4) Construct haul roads to widths suitable for safe operation of the equipment at the travel speeds proposed by the contractor and accepted by the KO or COR.

(5) Post maximum speed limit signs on all roads, including access and haul roads.

(6) Provide an adequate amount of turn-outs on single lane roads with two-way traffic. When turn-outs are not practical, the contractor must establish a traffic control system to prevent accidents.

(7) Whenever possible, use a right-hand traffic pattern on two-way haul roads.

(8) Horizontal Curves.

(a) All curves must have open sight lines and as great a radius as practical.

(b) Limit vehicle speed on curves so that vehicles can be stopped within one-half the visible distance of the roadway.

(c) The design of horizontal curves must consider vehicle speed, roadway width and surfacing, and superelevation.

(9) Grades.

(a) When necessary, based on grade and machine and load weight, equip machines with retarders to assist in controlling downgrade descent.

(b) Access and haul roads should be kept to 10 percent grade or less. There should be no more than 400 feet (121.9 m) of continuous grade exceeding 10 percent.

(c) Grades may not exceed 12 percent. Steeper grades may be allowed if sufficient evidence is provided to the USACE supervisor/KO or COR that all equipment using the haul road can operate on the designed slope, documented in the Access and Haul Road Plan and accepted by the local Chief of the SOHO.

(10) Provide adequate lighting (see chapter 7).

(11) Provide traffic control lights, barricades, road markings, signs, and flaggers for the safe movement of traffic according to the DOT Federal Highway Administration's MUTCD and this chapter.

(12) Maintain all roads so that they stay in a safe condition. Eliminate or control dust, ice, ruts, and similar hazards.

(13) Minimize the deposition of mud and or other debris on roads to the extent possible. Comply with state and local erosion, sediment, and runoff control requirements.

4-9. Figures and Tables.

Not Applicable.

4-10. Checklists and Forms.

Not Applicable.

Chapter 5

Personal Protective and Lifesaving Equipment

5-1. References.

a. American Conference of Government Industrial Hygienists (ACGIH), Threshold Limit Values (TLV) and Biological Exposure Indices (BEI)
(<https://www.acgih.org/publications/>) (5-1.a)

b. American Society for Testing and Materials (ASTM) Committee F18 Standards, Electrical Protective Equipment for Workers
(<https://www.astm.org/COMMIT/SUBCOMMIT/F18.htm>) (5-1.b)

c. ANSI/ASA S2.73/ISO 10819, Mechanical Vibration and Shock-Hand-arm Vibration – Measurement and Evaluation of the Vibration Transmissibility of Gloves at the Palm of the Hand (<https://webstore.ansi.org/>) (5-1.c)

d. ANSI/ASA S12.71, Performance Criteria for Systems that Estimate the Attenuation of Passive Hearing Protectors for Individual Users
(<https://webstore.ansi.org/>) (5-1.d)

e. ANSI/American Welding Society (AWS) Z49.1, Safety in Welding, Cutting, and Allied Processes (<https://webstore.ansi.org/>) (5-1.e)

f. ANSI/Compressed Gas Association (CGA) G-7.1, Commodity Specification for Air (<https://webstore.ansi.org/>) (5-1.f)

g. ANSI/ISEA Z87.1, American National Standard for Occupational and Educational Personal Eye and Face Protection (<https://webstore.ansi.org/>) (5-1.g)

h. ANSI/ISEA Z89.1, American National Standard for Industrial Head Protection, (<https://webstore.ansi.org/>) (5-1.h)

- i. ANSI/ISEA 105, American National Standard for Hand Protection Classification (<https://webstore.ansi.org/>) (5-1.i)
- j. ANSI/ISEA 107, American National Standard for High-Visibility Safety Apparel (<https://webstore.ansi.org/>) (5-1.j)
- k. ANSI/Laser Institute of America (LIA) Z136.1, American National Standard for Safe Use of Lasers (<https://webstore.ansi.org/>) (5-1.k)
- l. ANSI/VC Z80.3, Ophthalmics – Nonprescription Sunglass and Fashion Eyewear Requirements (<https://webstore.ansi.org/>) (5-1.l)
- m. ASTM D120, Standard Specification for Rubber Insulating Gloves (<https://www.astm.org/products-services/standards-and-publications.html>) (5-1.m)
- n. ASTM D1051, Standard Specification for Rubber Insulating Sleeves (<https://www.astm.org/products-services/standards-and-publications.html>) (5-1.n)
- o. ASTM F496, Standard Specification for In-Service Care of Insulating Gloves and Sleeves (<https://www.astm.org/products-services/standards-and-publications.html>) (5-1.o)
- p. ASTM F696, Standard Specification for Leather Protectors for Rubber Insulating Gloves and Mittens (<https://www.astm.org/products-services/standards-and-publications.html>) (5-1.p)
- q. ASTM F1116, Standard Test Method for Determining Dielectric Strength of Dielectric Footwear (<https://www.astm.org/products-services/standards-and-publications.html>) (5-1.q)
- r. ASTM F1117, Standard Specification for Dielectric Footwear (<https://www.astm.org/products-services/standards-and-publications.html>) (5-1.r)
- s. ASTM F1236, Standard Guide for Visual Inspection of Electrical Protective Rubber Products (<https://www.astm.org/products-services/standards-and-publications.html>) (5-1.s)
- t. ASTM F1449, Standard Guide for Industrial Laundering Care and Maintenance of Flame Resistant and Arc Rated Clothing (<https://www.astm.org/products-services/standards-and-publications.html>) (5-1.t)
- u. ASTM F1506, Standard Performance Specification for Flame Resistant and Electric Arc Rated Protective Clothing Worn by Workers Exposed to Flames and Electric Arcs (<https://www.astm.org/products-services/standards-and-publications.html>) (5-1.u)

- v. ASTM F1891, Standard Specification for Arc and Flame-Resistant Rainwear, (<https://www.astm.org/products-services/standards-and-publications.html>) (5-1.v)
- w. ASTM F1897, Standard Specification for Leg Protection for Chain Saw Users (<https://www.astm.org/products-services/standards-and-publications.html>) (5-1.w)
- x. ASTM F1959/F1959M, Standard Test Method for Determining the Arc Rating of Materials for Clothing (<https://www.astm.org/products-services/standards-and-publications.html>) (5-1.x)
- y. ASTM F2178/F2178M, Standard Specification for Arc Rated Eye or Face Protective Products (<https://www.astm.org/products-services/standards-and-publications.html>) (5-1.y)
- z. ASTM F2412, Standard Test Methods for Foot Protection (<https://www.astm.org/products-services/standards-and-publications.html>) (5-1.z)
- aa. ASTM F2413, Standard Specification for Performance Requirements for Protective (Safety) Toe Cap Footwear (<https://www.astm.org/products-services/standards-and-publications.html>) (5-1.aa)
- bb. ASTM F2675/F2675M, Standard Test Method for Determining Arc Rating of Hand Protective Products Developed and Used for Electrical Arc Flash Protection (<https://www.astm.org/products-services/standards-and-publications.html>) (5-1.bb)
- cc. ASTM F2677, Standard Specification for Electrically Insulating Aprons (<https://www.astm.org/products-services/standards-and-publications.html>) (5-1.cc)
- dd. ASTM F2757, Standard Guide for Home Laundering Care and Maintenance of Flame Resistant or Arc Rated Clothing (<https://www.astm.org/products-services/standards-and-publications.html>) (5-1.dd)
- ee. ASTM F3387, Standard Practice for Respiratory Protection (<https://www.astm.org/products-services/standards-and-publications.html>) (5-1. ee)
- ff. Department of Transportation (DOT), Federal Highway Administration's "Manual on Uniform Traffic Control Devices" (MUTCD) (<https://mutcd.fhwa.dot.gov>) (5-1.ff)
- gg. DoDI 6055.12, Hearing Conservation Program (<https://www.esd.whs.mil/directives/issuances/dodi/>) (5-1.gg)
- hh. ER 385-1-89, Hearing Conservation Program (<https://www.publications.usace.army.mil/USACE-Publications/Engineer-Regulations>) (5-1.hh)

- ii. ER 385-1-90, Respiratory Protection Policy
(<https://www.publications.usace.army.mil/USACE-Publications/Engineer-Regulations>) (5-1.ii)
- jj. NFPA 70E, Standard for Electrical Safety in the Workplace
(<https://www.nfpa.org/Codes-and-Standards>) (5-1.jj)
- kk. NFPA 1977, Standard on Protective Clothing and Equipment for Wildland Fire Fighting (<https://www.nfpa.org/Codes-and-Standards>) (5-1.kk)
- ll. NFPA 1989, Standard on Breathing Air Quality for Emergency Services Respiratory Protection (<https://www.nfpa.org/Codes-and-Standards>) (5-1.ll)
- mm. OSHA Technical Manual, Health Hazards, Section III: Chapter 5 Noise
(<https://www.osha.gov/otm/section-3-health-hazards/chapter-5>) (5-1.mm)
- nn. U.S. Department of Health and Human Services/National Institute for Occupational Safety and Health (NIOSH) 98-126, Occupational Noise Exposure, June 1998 (<https://www.cdc.gov/niosh/docs/98-126/>) (5-1.nn)
- oo. 29 CFR 1910 Subpart I, Personal Protective Equipment
(<https://www.govinfo.gov/content/pkg/CFR-2020-title29-vol5/pdf/CFR-2020-title29-vol5-part1910-subpartI.pdf>) (5-1.oo)
- pp. 29 CFR 1910.95, Occupational Noise Exposure
(<https://www.govinfo.gov/content/pkg/CFR-2020-title29-vol5/pdf/CFR-2020-title29-vol5-sec1910-95.pdf>) (5-1.pp)
- qq. 29 CFR 1910.134, Respiratory Protection
(<https://www.osha.gov/laws-regs/regulations/standardnumber/1910/1910.134>) (5-1.qq)
- rr. 29 CFR 1917.95, Other Protective Measures
(<https://www.govinfo.gov/content/pkg/CFR-2020-title29-vol7/pdf/CFR-2020-title29-vol7-sec1917-95.pdf>) (5-1.rr)
- ss. 29 CFR 1926.106, Working Over or Near Water
(<https://www.govinfo.gov/content/pkg/CFR-2020-title29-vol8/pdf/CFR-2020-title29-vol8-sec1926-106.pdf>) (5-1.ss)
- tt. 46 CFR 25.25, Life Preservers and Other Lifesaving Equipment
(<https://www.govinfo.gov/content/pkg/CFR-2020-title46-vol1/pdf/CFR-2020-title46-vol1-part25-subpart25-25.pdf>) (5-1.tt)
- uu. 46 CFR 117.70, Ring Life Buoys (<https://www.govinfo.gov/content/pkg/CFR-2020-title46-vol4/pdf/CFR-2020-title46-vol4-sec117-70.pdf>) (5-1.uu)

vv. 46 CFR 160, Lifesaving Equipment
(<https://www.govinfo.gov/content/pkg/CFR-2019-title46-vol6/pdf/CFR-2019-title46-vol6-part160.pdf>) (5-1.vv)

5-2. Definitions.

a. Air-Purifying Respirator. A respirator where ambient air is passed through an air-purifying element by either inhalation or with a blower. (5-2.a)

b. Arc Rating. A value of the incident energy (IE) necessary to pass through any given material, or multiple layers of materials, to cause, with 50% probability breakopen or onset of a second-degree skin burn injury. This value is measured in calories/cm². The necessary arc rating for an article of clothing is determined by performing an arc flash analysis or a risk assessment. Arc rating is reported as the lower value of either the arc thermal performance value (ATPV) or the energy breakopen threshold (EBT). (5-2.b)

c. Atmosphere-Supplying Respirator. A class of respirators that supply a respirable atmosphere, independent of the workplace atmosphere. This class includes airline respirators and self-contained breathing apparatus (SCBA). (5-2.c)

d. Canister/Cartridge. A container with a filter, sorbent, or catalyst, or combination of these items, which removes specific contaminants from the air passed through the container. (5-2.d)

e. Competent Person (CP). See paragraphs 1-2 or 2-2, as applicable. (5-2.e)

f. Decibel (dB). A unit used to measure the intensity of a sound (sound pressure level). (5-2.f)

(1) Decibel-A-Weighted (dBA). A-weighted decibel is an expression of the relative loudness of sounds in air as perceived by the human ear.

(2) Decibel-C-Weighted (dBC). C-weighted sound level is the sound pressure in decibels measured with a sound level meter using the C-weighting network and slow meter response. The C-weighted network correlates with the ear's response for the levels above 85 dB.

g. Drowning Hazards. Drowning hazards are associated with work on, over or adjacent to water and include the lack of life jackets, ring buoys and lifesaving skiffs and other devices. Drowning hazards also include work in confined spaces (see chapter 34) and during diving operations (see chapter 30). (5-2.g)

h. Dust. Solid particles generated by handling, crushing, grinding, or detonation of organic or inorganic materials. (5-2.h)

i. Filtering Facepiece Respirator. NIOSH-approved negative-pressure particulate respirator with a filter as an integral part of the facepiece or with the entire facepiece composed of the filtering medium. (5-2.i)

j. Fit Factor. A quantitative estimate of the fit of a particular respirator to a specific individual, and typically estimates the ratio of the concentration of a substance in ambient air to its concentration inside the respirator when worn. (5-2.j)

k. Fit Test. The use of a qualitative or quantitative protocol to evaluate sealing surface leakage of a specific tight-fitting respirator while worn by an individual. (5-2.k)

l. Hazardous Noise. Noise exceeding 85 dBA. (5-2.l)

m. High Visibility Safety Apparel (HVSA). Personal protective safety clothing intended to provide conspicuity during both daytime, nighttime, and other low-light condition usage. (5-2.m)

(1) Class 2 HVSA. A category of safety clothing that increases the visibility of the wearer in both daytime and nighttime conditions. Performance Class 2 HVSA is the minimum practice for HVSA in roadway rights-of-way, temporary traffic control zones, and where traffic is moving at or below 35 miles per hour (mph) (56.3 kilometers per hour (km/h)). Class 2 HVSA must have at least 201 in² (1926.8 cm²) of reflective material. See the MUTCD and ANSI/ISEA 107 for required amount of non-reflective material.

(2) Class 3 HVSA. A category of safety clothing that offers greater visibility to the wearer in complex backgrounds (for example, roadways where traffic is traveling in excess of 35 mph (56.3 km/h), emergency personnel or tow truck operators working in blizzard or hurricane conditions). Class 3 HVSA requires 310 in² (2000 cm²) of reflective material. Apparel often resembles a short sleeve t-shirt; a sleeveless garment or vest alone is not considered Performance Class 3. See ANSI/ISEA 107 for required amount of non-reflective material.

(3) Class E HVSA. Supplemental apparel comprised of high visibility garments such as pants, bib overalls, shorts, and gaiters. These items do not qualify as meeting the requirements of the standard when worn alone, however, when a Class E item is worn with a Class 2 or Class 3 garment, the overall classification of the ensemble is Class 3. (See ANSI/ISEA 107)

(4) Type P HVSA. “Public safety,” emergency responder, law enforcement worker apparel that provides daytime and nighttime visual conspicuity enhancement in occupational environments that include exposure to traffic from public access highway rights-of-way or roadway temporary traffic control zones, or from work vehicles and construction equipment within a roadway temporary traffic control zone or from equipment and vehicles within the activity area. Type P HVSA provides additional

options for emergency responders, incident responders and law enforcement who have compounding hazards or require access to special equipment. (See ANSI/ISEA 107)

(5) Type R HVSA. "Roadway use" apparel that provides daytime and nighttime visual conspicuity enhancement for workers in occupational environments that include exposure to traffic from public access highway rights-of-way or roadway temporary traffic control zones, or from work vehicles and construction equipment within a roadway temporary traffic control zone. (See ANSI/ISEA 107)

n. Immediately Dangerous to Life or Health (IDLH). An atmosphere that poses an immediate threat to life, would cause irreversible adverse health effects, or would impair an individual's ability to escape from a dangerous atmosphere. IDLH values are often used to guide the selection of breathing apparatus made available to workers or firefighters in specific situations. (5-2.n)

o. Impulse Noise. The pressure-time history of a single impulse includes a rise of 40 dB or more in 1 second or faster to a peak pressure, followed by a somewhat slower decay of the pressure envelope to ambient pressure, both occurring within 1 second. When the intervals between impulses are less than 500 milliseconds, the noise is considered continuous, except for short bursts of automatic weapons fire, which are considered impulse noise. (5-2.o)

p. Negative Pressure Respirator/Tight-Fitting Facepiece Respirator. A respirator in which the air pressure inside the facepiece is negative during inhalation with respect to the ambient air pressure outside the respirator. (5-2.p)

q. Ototoxic Chemicals. An agent known to have adverse effects on organs or nerves involved in hearing or balance and may be physical (for example, noise), biological, or chemical. Examples include arsenic, carbon disulfide, carbon monoxide (CO), cyanide, lead and derivatives, manganese, mercury and derivatives, n-hexane, Stoddard solvent, styrene, trichloroethylene, toluene, xylene. (5-2.q)

r. Personal Flotation Device (PFD). A piece of equipment designed to assist a wearer to keep afloat in water. The wearer may be either conscious or unconscious. Commonly referred to as a life jacket, life preserver, life belt, Mae West, life vest, life saver. (5-2.r)

s. Personal Protective Equipment (PPE). Any equipment worn to minimize exposure to hazards that cause serious workplace injuries and illness. (5-2.s)

t. Physician or Other Licensed Health Care Professional (PLHCP). A physician or other licensed health care professional is an individual whose legally permitted scope of practice (that is, license, registration, or certification) allows him or her to independently perform, or be delegated the responsibility to perform, the activities of a physician. (5-2.t)

u. Qualitative Fit Test (QLFT). A pass/fail fit test to assess the adequacy of respirator fit that relies on the individual's response to the test agent. (5-2.u)

v. Quantitative Fit Test (QNFT). An assessment of the adequacy of respirator fit by numerically measuring the amount of leakage into the respirator. (5-2.v)

w. Radiant Energy. The energy of electromagnetic waves produced by movement of molecules excited by the heat of an electric arc, gas flame, or the passage of electric current. Includes ultraviolet, visible light, and infrared energy. (5-2.w)

x. Sound-Pressure. Steady state sound that does not significantly change in intensity or frequency with time. (5-2.x)

y. Supplied-Air Respirator (SAR) or Airline Respirator. An atmosphere-supplying respirator for which the source of breathing air is not designed to be carried by the user. (5-2.y)

z. Threshold Limit Values (TLV). Airborne concentrations of chemical substances and represent concentrations under which it is believed that nearly all workers may be repeatedly exposed, day after day, over a working lifetime, without adverse health effects. (5-2.z)

aa. Vessel. Every type of watercraft or artificial contrivance used, or capable of being used, as a means of transportation on water, including special-purpose floating structures not primarily designed for or used as a means of transportation on water. (5-2.aa)

bb. Wildland Fire. A planned or unplanned fire involving wildland fuels. (5-2.bb)

5-3. Personnel Required Qualification/Training.

a. Personnel Protective Equipment (PPE). All employees required to use PPE must be trained and demonstrate an understanding of the following for each component of PPE prior to use: (5-3.a)

(1) Proper use, to include knowing when to use, selecting the appropriate PPE for specific hazards, donning, doffing, and adjusting.

(2) Care procedures, to include maintenance, inspection, testing, storage, cleaning, and disposal.

(3) Any limitations of the equipment, to include the useful life.

b. Hearing Protection. (5-3.b)

(1) Employees exposed to hazardous noise and/or ototoxic chemicals must be trained according to 29 CFR 1910.95 (contractors) or ER 385-1-89 (USACE only).

(2) Personnel who perform noise evaluations must be trained according to ER 385-1-89 (USACE only).

c. Respiratory Protection. When respiratory protection is required, employees must be qualified and trained according to the following: (5-3.c)

(1) Respiratory Protection Program Administrator (RPPA).

(a) USACE RPPAs must meet the training and qualifications according to ER 385-1-90.

(b) Contractor RPPAs must have documented knowledge and experience to understand OSHA's respiratory protection standard (that is, 29 CFR 1910.134) evaluate respiratory hazards, select appropriate respirators based on identified hazards, and train employees on respirator use.

(2) Respiratory Protection Program Manager (RPPM) (USACE only). USACE RPPMs must meet the training and qualifications according to ER 385-1-90.

(3) Respirator Users. In addition to the elements identified for general PPE training, all employees required to use respirators must be trained before initial use and annually by an RPPA/RPPM thereafter on the following:

(a) Why the respirator is necessary and how improper fit, usage, or maintenance can compromise the protective effect of the respirator.

(b) Capabilities and limitations of the respirator.

(c) How to use the respirator effectively in emergency situations, including situations in which the respirator malfunctions.

(d) How to inspect, put on and remove, use, and check the seals of the respirator.

(e) Procedures for maintenance, cleaning, storage, and disposal of the respirator.

(f) How to recognize medical signs and symptoms that may limit or prevent the effective use of respirators.

(g) The general requirements of the OSHA respiratory protection standard, 29 CFR 1910.134.

(4) Voluntary Respirator Users. Employees who choose to voluntarily use a respirator must be trained on the following:

(a) Correct method of wearing, cleaning, using, and disposal of the respirator.

(b) Limitations of the respirator.

(c) The requirements of 29 CFR 1910.134, Appendix D.

d. Automatic-Inflatable Personal Floatation Device (PFDs) Users. Users of automatic-inflatable PFDs must be trained in the use, including restrictions, maintenance, care, cleaning, storage, inspection, and post-deployment procedures according to the manufacturer's instructions before use. Wearer must be a confident swimmer (that is, able to tread water and swim for 100'). (5-3.d)

e. Lifesaving and Safety Skiffs. When lifesaving and/or safety skiffs are required, employees must be trained to launch and operate the skiff (see para 19-3). (5-3.e)

f. Retraining. When the employer has reason to believe that any affected employee who has been trained does not have the understanding and skill required for the use of the PPE, the employer must retrain the employee to acquire the appropriate skills. (5-3.f)

5-4. Roles and Responsibilities.

a. Employer. The employer is responsible for performing a hazard evaluation of the workplace and performed activities to identify associated hazards and applicable controls. (5-4.a)

(1) To properly identify and assess such hazards, obtain input from SOH personnel or other CPs to review the hazard evaluation and assist when selecting control measures.

(2) When hazards are identified that cannot be eliminated and/or controlled to an acceptable level through higher level controls (see hazard mitigation in paras 1-6 or 2-6, as applicable), PPE may be required. The decision to use PPE must be documented and communicated to each affected employee. Identify necessary PPE for work activities in the applicable AHAs and PHAs. See chapters 1 or 2, as applicable, and paragraph 5-6.

(3) Make all reasonable efforts to accommodate employees with religious beliefs that may conflict with determined PPE requirements. However, when such efforts do not provide the necessary protection (that is, without PPE), require that the employee use the PPE or prohibit the employee from working in the area where the hazard requiring protection exists.

(4) Provide the required PPE for employee use. When employees provide their own PPE, ensure it is adequate to protect against the hazards, including it is properly maintained and sanitized.

b. Employees. Use all PPE and safety equipment as directed by the employer and this manual. (5-4.b)

c. Respiratory Protection. The following roles and responsibilities are specific to respiratory protection (that is, when respirators are required to be used): (5-4.c)

(1) (USACE) Command SOHO. Identify and designate, in writing, an RPPA with the technical qualifications (see ER 385-1-90 Appendix E) and administrative authority to develop, implement, and update (as necessary) the district's Respiratory Protection Program (RPP). The RPPA provides guidance and technical support to organizations responsible for developing and implementing RPPs.

(2) (USACE) RPPM. An RPPM must be assigned, in writing, by all command organizations requiring a RPP. The RPPM administers the program with support of the RPPA and command SOHO.

(3) RPPA/RPPM. The RPPA/RPPM or their designee must provide respirator use training annually (or earlier if the requirements change significantly due to process changes or changes in site specific operations) to personnel using respirators at the facility or project. (USACE) The RPPM must develop annual training requirements with help from the district IH or RPPA.

5-5. Inspection Requirements.

a. General. Keep a copy of the manufacturer's use, inspection, testing, and maintenance instructions at the jobsite and have it readily available to personnel using the PPE and safety equipment. (5-5.a)

b. Personal Protective Equipment (PPE). Test, inspect, and maintain PPE in a serviceable and sanitary condition according to the manufacturer's instructions. (5-5.b)

(1) At minimum, PPE must be visually inspected before each use.

(2) Do not use defective or damaged equipment, or equipment that has exceeded its useful life. Tag it as out of service and/or immediately remove it from the work site to prevent use.

(3) Previously used PPE must be cleaned, inspected, and repaired as necessary before issuing to another employee.

5-6. Activity Hazard Analysis (AHA) Requirements.

Develop AHAs according to paragraphs 1-6 or 2-6, as applicable. Each AHA must include all required PPE and safety equipment, including type, quantity, ratings, and any replaceable materials. Select PPE and safety equipment according to the specific protection in paragraph 8 of this chapter, or as otherwise stated in this manual.

5-7. Minimum Plan Requirements.

a. Hearing Conservation Program (HCP). An HCP is required when employees are exposed to hazardous noise and/or toxic chemicals. USACE employees will follow ER 385-1-89. When required, contractors must develop and implement a written, site-specific HCP according to 29 CFR 1910.95, ACGIH TLVs, and this manual, to include the following: (5-7.a)

(1) The identification and documentation of the engineering controls, PPE, and hearing testing for all employees.

(2) Employee training on the hazards of noise and the methods of protection provided (see para 5-3.b).

(3) Labeling of all noise hazardous equipment and areas as required above.

(4) Pre-employment, annual, position change, and end-of-employment hearing testing of individuals working in noise hazardous environments greater than 30 days a year.

b. Respiratory Protection Program (RPP). A RPP is required when employees are required to use respirators. A written site-specific RPP must be developed and implemented according to this manual, 29 CFR 1910.134 (contractors), and ER 385-1-90 (USACE), to include the following: (5-7.b)

(1) Methods used to identify and evaluate workplace respiratory hazards.

(2) Procedures for selecting respirators for use in the workplace.

(3) Medical evaluations of employees required to use respirators.

(4) Fit testing procedures for tight-fitting respirators.

(5) Procedures for proper use of respirators in routine and reasonably foreseeable emergency situations.

(6) Procedures and schedules for cleaning, disinfecting, storing, inspecting, canister/cartridge change-out, repairing, discarding, and otherwise maintaining respirators.

(7) Procedures to ensure adequate air quality, quantity, and flow of breathing air for atmosphere-supplying respirators.

(8) Training of employees in the respiratory hazards to which they are potentially exposed during routine and emergency situations (see para 5-3.c).

(9) Training of employees in the proper use of respirators, including putting on and removing (donning and doffing) the respirator, any limitations on their use of the respirator, pre-use testing procedures, and respirator maintenance (see para 5-3.c).

(10) Procedures for regularly evaluating the effectiveness of the program.

(11) Project/facility-specific voluntary use guidelines and a requirement for voluntary users to learn and understand the contents of 29 CFR 1910.134 Appendix D, (Mandatory) Information for Employees Using Respirators When Not Required under the Standard.

5-8. General Requirements.

a. Minimum Requirements. (5-8.a)

(1) Employees must wear clothing suitable for the weather and work conditions. For fieldwork (for example, construction sites, industrial operations and maintenance activities, emergency operations, regulatory inspections), at a minimum, this is:

(a) Short sleeve shirt.

(b) Long pants (excessively long or baggy pants are prohibited).

(c) Leather or other protective footwear. Open-toed shoes are prohibited (see para 5-8.i.).

(2) The use of PPE and safety equipment is a control measure that should only be used after a hazard evaluation is performed and it is determined that the hazards cannot be eliminated and/or controlled to an acceptable level through engineering design or administrative actions, or as a secondary control to provide an additional layer of protection. See paragraphs 5-4 and 1-6.a or 2-6.a, as applicable.

(a) Employers must identify and provide the required PPE for employee use. Identify PPE required for work activities in the applicable AHAs and PHAs. See paragraph 5-6 and chapters 1 or 2, as applicable.

(b) Employees must use all PPE and safety equipment as directed by the employer and this manual (see para 5-4).

(3) All employees required to use PPE must be trained according (see para 5-3).

(4) All PPE must be inspected, tested, and maintained according to the manufacturer's instructions (see para 5-5).

b. Head Protection (that is, hard hats or helmets). Head protection is required when there is a potential for head injury from, to include but not limited to, impact, falling or flying objects, or electrical burns. (5-8.b)

(1) Select the proper head protection based on the activity and according to the manufacturer's instructions.

(a) All head protection must meet the requirements of ANSI Z89.1.

(b) All persons working in or visiting hard hat areas must be provided with and required to wear Type I or Type II, Class G or Class E head protection as appropriate.

(c) Select Type II head protection for emergency response operations and other activities with greater need for side impact protection (see chapter 37).

(d) Class E head protection must be worn when working near or on electric lines and equipment.

(2) Generally, all construction areas are considered hard hat areas. However, specific areas may be designated as non-hard hat areas or activities may be considered non-hard hat activities, if identified and properly documented in the associated AHA.

(3) Post a warning sign requiring the use of head protection according to chapter 8.

(4) Do not make any modifications to a hard hat or helmet shell, suspension, or other associated components (for example, paint, drill holes), except when such changes are applied or approved by the manufacturer. Stickers are allowed provided they do not interfere with the ability to properly inspect it.

(5) Do not wear ball caps, knit caps, or other headdress under the head protection that could interfere with the fit or stability, unless authorized or provided by the manufacturer.

(6) Perform a daily visual inspection of protective headgear and components for signs of damage (for example, dents, cracks) that might reduce the degree of safety integrity originally provided. Periodically inspect headgear for ultraviolet degradation as evidenced by cracking or flaking of the helmet. (See para 5-5)

(7) Wear chin straps on hard hats or helmets during high wind conditions or working on elevated structures.

(8) Protective headgear worn by USACE employees must, in addition to complying with the preceding specifications, be:

(a) White in color and marked with a 1-inch (2.5 cm) band of red reflective material placed along the base of the crown with 5 inches (12.7 cm) break in front. Have a red Corps of Engineers castle insignia centered at the front of the hat with the base of the insignia approximately three-quarter ($\frac{3}{4}$) inch (1.9 cm) above the base of the crown. Personnel may place their name above the insignia and their organization title below the insignia. The rank of military personnel should precede their name. An American Flag insignia may be worn on the back of the hard hat.

(b) Submit requests for variations in color and marking to accommodate occupational specialties for consideration to HQUSACE-SO.

c. Eye and Face Protection. Eye and/or face protection is required when there is a potential for eye and/or face injury (see table 5-1). (5-8.c)

(1) Eye and face protection must meet the requirements of ANSI/ISEA Z87.1 and bear a legible and permanent "Z87" logo to indicate compliance with the standard.

(2) Eye and face protection must be distinctly marked to identify manufacturer.

(3) When eye protection is required, protect those whose vision requires the use of corrective lenses, whether via the use of contact lenses or eyeglasses, by one of the following:

(a) Prescription safety glasses providing optical correction and equivalent protection.

(b) Protective glasses with side shields designed to fit over corrective lenses without disturbing the adjustment of the glasses.

(c) Goggles that can be worn over corrective lenses without disturbing the adjustment of the glasses.

(d) Goggles that incorporate corrective lenses mounted behind the protective lenses.

(4) Personnel who are considered blind in one eye and are working in other than administrative functions must always wear safety glasses with side shields.

(5) Operations involving the handling of harmful materials (for example, acids, caustics, hot liquids, creosoted materials) and operations where protection from gases, fumes, and liquids is necessary require the wearing of goggles with cups of soft pliable rubber and suitable face shields, masks, or hoods that cover the head and neck, and other protective clothing appropriate to the hazards involved.

(6) Wear ANSI Z80.3 compliant glare-resistant glasses with an ultraviolet A-region (UVA) and ultraviolet B-region (UVB) 99% filtration when conditions require protection

against glare. When conditions so warrant, polarized lenses must also be considered. Tinted or automatically darkening lenses should not be worn when work tasks require the employee to pass often from brightly to dimly lighted areas. For welding, cutting, brazing and soldering operations see table 5-2 for required shades.

d. Hearing Protection and Noise Control. Hearing protection is required when occupational exposure limits (OELs) are exceeded and engineering and/or administrative exposure controls are either infeasible or unable to reduce exposure levels to an acceptable level, or when required by regulation. (5-8.d)

(1) Conduct a noise evaluation and take noise measurements initially and regularly during work, or whenever there is difficulty in communicating at distances less than 3 feet (0.9 m) apart, upon worker complaint of excessive noise, or whenever hazardous noise levels are suspected. Personnel who perform noise evaluations must be trained according to ER 385-1-89 (USACE only). (See para 5-3.b)

(2) Noise Measurement Instruments. When conducting noise measurements, adhere to the following:

(a) For continuous (steady-state) noise and impact (impulse) noise, set the instrument according to table 5-3.

(b) Use noise dosimeters that can measure the employee's entire work shift for full-shift sampling.

(c) Calibrate noise measuring equipment according to the manufacturer's instructions. (USACE refer to ER 385-1-89)

(3) Employee Exposure. To assess employee exposures to noise, contractors must follow the ACGIH TLV continuous noise exposure standards in table 5-4, whereas USACE must follow ER 385-1-89.

(a) For impact (impulse) noise, personnel exposures must not exceed 140 dBC without effective hearing protection devices.

(b) For continuous (steady-state) noise, personnel exposures must not exceed 85 dBA without effective hearing protection devices.

(c) When the daily noise exposure is composed of two or more periods of noise exposure of different levels, the combined effects must be considered. See ACGIH TLVs and BEIs for additional information.

(4) When hazardous noise and/or exposure to ototoxic chemicals is known or expected, develop a HCP according to paragraph 5-7.a.

(5) Control Measures. When personnel are exposed to noise levels exceeding the limits identified in paragraph 5-8.d(3), control measures must be implemented according to the following. Identify necessary control measures for work activities in applicable AHAs. (See para 5-6)

(a) Engineering controls are the most effective of controlling exposures to excessive noise in the workplace. Implement when possible. These controls may include lubrication, isolation, damping, baffles, or other methods.

(b) Administrative Controls.

(b-1) Post all noise-hazardous areas and equipment to indicate the presence of hazardous noise levels and the requirement for hearing protection. If noise hazards impact personnel working in adjacent areas, notify the individuals in the adjacent areas of the noise values and offer hearing protection.

(b-2) If noise exposure to employees cannot be reduced to below the required standard, operating time limits may be imposed.

(c) PPE.

(c-1) Hearing protection devices must provide for the attenuation of noise to acceptable levels (that is, 85 dBA for continuous (steady-state) noise). If necessary to hear audible warnings, hearing protection devices should not attenuate noise levels below an individual's hearing threshold (that is, approximately 20-30 dBA).

(c-2) Double hearing protection (that is, the combination of earplugs with earmuffs) is required whenever employees are exposed to continuous noise greater than 103 dBA and up to 108 dBA. Double hearing protection may not attenuate the noise sufficiently at steady- state noise levels greater than 108 dBA. Therefore, more control measures (for example, limiting individual exposure time) are required.

(c-3) Determine the attenuation of the specific hearing protection, except custom ear mold hearing protection, using the NIOSH de-rating scheme. See NIOSH 98-126 and OSHA Technical Manual, Health Hazards, Section III: Chapter 5 Noise for estimating the de-rating of hearing protection.

(c-4) Ear insert devices, to include disposable, pre-formed, or custom-molded earplugs, must be fitted to the exposed individual by an individual trained in such fitting and able to recognize the difference between a good and poor fit. Plain cotton is not an acceptable hearing protection device.

(c-5) An earplug carrying case must be provided to exposed employees when feasible.

(c-6) Employees required to wear hearing protection must be trained according to paragraph 5-3.b.

e. Respiratory Protection. Respirators are required when OELs are exceeded and engineering and/or administrative exposure controls are either infeasible or unable to reduce exposure levels to an acceptable level, or when required by regulation. See 29 CFR 1910.134 (contractors) and ER 385-1-90 (USACE). (5-8.e)

(1) When respiratory protection is required in the form of respirators, develop a RPP according to paragraph 5-7.b. For roles and responsibilities of the RPP, see paragraph 5-4.c, and for applicable training requirements see paragraph 5-3.c.

(2) Respirator Selection and Use. Respirators must be selected by the RPPA (contractor)/RPPM in coordination with the RPPA (USACE) based on knowledge of the hazards and work methods to determine the highest potential exposure. Objective industrial hygiene data for the particular task or similar operations, as applicable, may also be used to assist in selection.

(a) All respirators must be NIOSH-certified.

(b) Respirator canisters/cartridges must be changed out according to the manufacturer's instructions or as specified by the RPPA/RPPM based on the operations, the objective industrial hygiene data, or from knowledge of similar operations.

(c) Do not use air-purifying respirators in atmospheres with less than 19.5% oxygen or in an atmosphere that is IDLH.

(d) If atmosphere-supplying respirators (for example, SARs, SCBAs) are used, the following requirements apply (excludes underwater diving SCBAs, see chapter 30):

(d-1) Air supply must meet the Grade D breathing air requirements according to ANSI/CGA G-7.1. Representative samples of purchased breathing air must be taken and tested according to ASTM F3387 using an NFPA 1989 accredited lab.

(d-2) If used in an atmosphere that has the potential to become IDLH, the respirator must have an alternate source of breathing air for escape from the environment.

(d-3) If an airline respirator is used in an environment that has the potential to become IDLH, a respirator air attendant must be present to prevent the lines from becoming tangled or tied, to change the air supply tanks, and/or to confirm the air source (for example, compressor, air supply tank manifold) is adequately working. If the air supply is interrupted, the attendant must immediately notify the respirator user to leave the area where respirator use is required.

(3) Fit Testing. Perform fit testing on all employees required to wear respirators with tight-fitting face pieces, including SARs and SCBAs, according to the procedures identified in the RPP to ensure that selected respirators achieve a proper face-to-facepiece seal. Fit testing must be performed before initial use of the selected respirator, whenever respirator size, make or model is changed, and at least annually.

(4) Medical Evaluation. All respirator users, except for employees approved for voluntarily use of filtering facepieces as specified in paragraph 5-8.e(6) below, must be medically evaluated to ensure they are fit enough to wear the selected respirators before being fit tested. All USACE respirator users must have a pre-placement history and targeted physical according to ER 385-1-90. Evaluation options for respirator use include:

(a) Completion of the respirator questionnaire from 29 CFR 1910.134, Appendix C, OSHA Respirator Medical Evaluation Questionnaire. A PLHCP will review the questionnaire and may recommend medical exams and testing. The employer must ensure that a follow-up medical examination is provided for the PLHCP recommendations prior to the user receiving medical clearance.

(b) Respirator Medical Evaluation Service. An online, mail-in or in-person evaluation service for the purpose of clearing an employee to wear selected respirators may be used provided it is supervised by a PLHCP and based upon to 29 CFR 1910.134, Appendix C.

(c) Provide additional medical evaluations when an employee reports medical signs or symptoms that are related to the ability to use a respirator; or a change occurs in workplace conditions (for example, physical work effort, protective clothing, temperature) that may result in a substantial increase in the physiological burden placed on an employee.

(d) Medical Clearances. Medical clearances to wear respirators must include the following:

(d-1) Telephone, e-mail, and physical address of the medical facility/provider.

(d-2) Printed name of the PLHCP along with his/her signature.

(d-3) The statement of clearances or respiratory limitations only (that is, no personal medical information or employee social security number may be included).

(d-4) Date of examination and date that clearance expires.

(5) Recordkeeping. Employers (Contractor)/RPPM (USACE) must establish and retain written information regarding medical evaluations, fit testing, and the respirator program. The following must be made available upon request:

(a) Records of medical approval.

(b) Fit test records must be kept for respirator users until the next fit test is administered. Establish a record of the QLFT and QNFT administered to an employee including:

(b-1) The name or identification of the employee tested.

(b-2) Type of fit test performed and name of the test administrator.

(b-3) Specific make, model, style, and size of respirator tested.

(b-4) Date of test.

(b-5) The pass/fail results for QLFTs or the fit factor and strip chart recording or other recording of the test results for QNFTs.

(6) Voluntary Use. The employer may allow the voluntary use of NIOSH-approved particulate filtering facepiece respirators (for example, N-95, P-95) in atmospheres that are below acceptable OELs (that is, a respirator is not required) and where such use will not in itself create a hazard, as determined by the RPPA (contractor)/RPPM in coordination with the RPPA (USACE). Before such use, the employee must be trained according to paragraph 5-3.c(4).

f. High-Visibility Safety Apparel (HVSA). HVSA is required when there are hazards associated with personnel visibility. (5-8.f)

(1) All HVSA must meet the requirements of ANSI/ISEA 107.

(2) Class 2 (Type R or P) HVSA must be worn whenever:

(a) There is limited visibility of workers exposed to mobile/heavy equipment operations, vehicles, load handling, or other hazardous activities.

(b) Reduced visibility conditions exist due to weather conditions (for example, rain, snow), illumination, or visually complex backgrounds where ambient visibility is at least 50 feet (15.2 m).

(c) Workers are exposed to vehicular or equipment traffic at speeds up to 35 mph (56.3 km/h).

(3) Class 3 (Type R or P) HVSA must be worn whenever:

(a) Reduced visibility conditions exist due to weather conditions (for example, rain, snow), illumination, or visually complex backgrounds where ambient visibility is less than 50 feet (15.2 m).

(b) Workers are exposed to vehicular or equipment traffic in excess of 35 mph (56.3 km/h).

(c) Workers are performing tasks which divert attention from approaching vehicular traffic, traveling in excess of 35 mph (56.3 km/h), as posted.

(d) Workers are involved in activities near vehicular traffic with no protective barriers.

(4) When working at night, on or near sites where vehicles are present, workers must wear, at a minimum, a Class 3 high-visibility safety coverall/jumpsuit or a Class 3 high-visibility safety jacket and Class E high-visibility pants, or bib overalls.

(5) If the use of high-visibility safety apparel proves to create a greater hazard due to moving machinery, pinch points, heat stress, or other reasons, develop an AHA detailing rationale for infeasibility of use and alternate safety measures to be used to ensure same level of worker safety and submit to the USACE supervisor for approval or acceptance by the KO or COR. Work may not commence until such acceptance has been obtained. (See para 5-6)

(6) The apparel background material color must be either fluorescent yellow-green, fluorescent orange-red, or fluorescent red (see ANSI/ISEA 107). When choosing color, consider optimization of color conspicuity between the wearer and work environment.

(7) All high-visibility apparel must be:

(a) Free of roughness, sharp edges, or projections that could cause irritation or injury.

(b) Correctly fitted to ensure that it remains in place for the expected period of use, environmental conditions, and wearer movements.

(c) Cleaned, laundered and/or dry-cleaned according to the manufacturer's instructions (for example, the label located on the apparel).

(d) In useable condition with limited rips, tears or fading.

(e) Inspected to ensure that the PPE meets the updated performance requirements including background material and reflective or combined-performance material and has been tested by an accredited laboratory.

(f) Replaced if it does not comply with any of the above or ANSI/ISEA 107.

g. Personal Flotation Devices (PFD). PFDs are required when there are hazards associated with water, to include but not limited to drowning. (5-8.g)

(1) Employers must provide, and users must properly wear (that is, zipped, tied, latched) inherently buoyant Type III, Type V work vests, or better USCG-approved PFDs in the following circumstances (see figure 5-1):

(a) On floating pipelines, pontoons, rafts, or stages.

(b) On structures or equipment extending over or next to water except where guardrails, personal fall protection system, or safety nets are provided for employees (see chapter 21).

(c) Working alone at night where there are drowning hazards, regardless of other safeguards provided.

(d) On vessels or floating plants, unless inside an enclosed cabin or cockpit.

(e) Whenever there is a drowning hazard.

(2) Automatic-inflatable PFDs Type V or better, USCG-approved for Commercial Use, may be worn by workers in lieu of paragraph 5-8.g(1), provided the following criteria is met:

(a) Personnel must be trained according to paragraph 5-3.d.

(b) In-water testing is performed prior to use for all first-time users so that wearers become familiar with the feel and performance of the PFD.

(c) PFDs must be inspected, maintained, stowed, and used according to the manufacturer's instructions. PFDs used in heavy construction or maintenance activities, or where hot work (for example, welding, brazing, cutting, soldering) is performed, must be designed, tested, and certified by the manufacturers for this type of work. An AHA must be developed for the intended activity and must identify the most appropriate PFD for the hazard(s) identified. (See para 5-6)

Note. The standard commercial auto-inflatable PFD often does not meet these requirements.

(d) PFDs must provide a 30-pound minimum buoyancy, post-deployment, and must have a status indicator window.

(e) PFDs are worn by workers over 16 years of age who weigh 90 lbs. (40.8 kg) or more.

(f) All auto-inflatable PFDs must be worn at all times a drowning hazard exists. The USCG-approval for auto-inflatable PFDs is contingent upon the PFD being worn, not stowed.

(3) All wearable PFDs must be international orange, orange/red, or ANSI 107 yellow-green in color.

(a) Each inherently buoyant PFD must have at least 31 in² (200 cm²) of retroreflective material attached to its front side and at least 31 in² (200 cm²) on its back side, per USCG requirements (see 46 CFR Part 25.25-15).

(b) Each auto-inflatable PFD must have at least 31 in² (200 cm²) of retroreflective material attached to its front side and at least 31 in² (200 cm²) on its bladder that is visible when deployed (with the exception of Work Vests, which are allowed to have a total of 31 in² (200 cm²) front and back, combined).

(4) Equip each PFD with a USCG-approved automatically activated light. Lights are not required for PFDs on projects performed exclusively during daylight hours.

(5) Before and after each use, inspect PFDs for defects that would alter its strength or buoyancy.

(6) Throwable Devices (Type IV PFD). See chapter 19 for requirements when working on vessels.

(a) All throwable devices must be USCG-approved.

(b) Ring buoys must be readily available and at intervals of not more than 200 feet (61 m) on pipelines, walkways, wharves, piers, bulkheads, lock walls, scaffolds, platforms, and similar structures extending over or immediately next to water. When the fall distance to the water is more than 45 feet (13.7 m), life rings must be used.

(c) Ring buoys must have at least 90 feet (27.4 m) of three-eighths (3/8) inch (1 cm) of attached solid braid polypropylene, or equivalent. Life rings are not required to have rope attached.

(d) Equip all PFDs with retroreflective tape according to USCG requirements.

(e) On all non-USCG inspected vessels and shore installations, lights on life rings are required only in locations where adequate general lighting (for example, floodlights, light stanchions) is not provided. For these plant and installations, at least one life ring, and every third one thereafter must have an automatic floating electric water light attached.

(f) Store all devices in such a manner as to allow immediate deployment and will be protected from degradation from weather and sunlight.

(g) Throw bags may be used in addition to life rings or ring buoys.

(h) These throwable devices and lifelines must be inspected at a minimum, every six months.

(7) Safety Blocks. At all navigation locks, perform an analysis of the benefits versus the hazards of using floating safety blocks (that is, blocks that may be quickly pushed into the water to protect individuals who have fallen in the water from being crushed by vessels). If the use of blocks is found acceptable, consider the size and placement of the blocks, the appropriate means of securing and signing the blocks, etc. When the use of blocks is found unacceptable, develop alternative safety measures.

h. Hand Protection. Hand protection is required when there is a potential for hand injury from, to include, but not limited to, absorption of harmful substances, cuts or lacerations, abrasions, punctures, chemical burns, thermal burns, temperature extremes, or vibration (see table 5-5). (5-8.h)

(1) Select appropriate hand protection based on an evaluation of the performance characteristics of the hand protection relative to the task(s) to be performed, conditions present, duration of use, and the hazards and potential hazards identified.

(2) Gloves must fit snugly.

(3) All hand protection must meet the requirement of ANSI 105, ASTM F18 (Electrical hazard resistance), F2292 (cut resistance) (see also table 5-6), F2878 (needle puncture resistance), F739 (Chemical permeation), D3889 or D3884 (Abrasion resistance), F 1358 (Heat and Flame Protection), F1060 (Conductive Heat Resistance), and ANSI S2 (Vibration Reduction).

i. Protective Footwear. Foot protection is required when there is a potential for foot injury from, to include but not limited to, impact, puncture, or electrical hazards. (5-8.i)

(1) Protective footwear providing protection against impact and compressive forces, conduction hazards, electrical hazards, slip resistance, and sole puncture must meet ASTM F2413 and ASTM F2412. Footwear providing protection against impact and compression hazards must be rated as I/75 and C/75. Employees may wear protective footwear that the employer demonstrates to the USACE supervisor/KO or COR satisfaction is at least as effective as protective footwear that is constructed according to either of the two ASTM standards.

(2) Add on devices, such as protective toe caps and puncture resistant devices, are allowed as long as they are used as an integral and permanent part of the protective footwear and meet the requirements of ASTM F2413.

(3) Unexploded ordnance (UXO) personnel whose job tasks require protective footwear but require no metal parts in or on their footwear must wear conduction protective footwear with protective toe cap/composite toe footwear.

(4) Personnel participating in wild land fire management activities must wear NFPA 1977 compliant leather lace-up boots with slip-resistant soles, such as a hard rubber lug-type or tractor tread, and a top height of 8 inches (20.3 cm) or more. Soles must not be made of compounds that have low melting points (for example, rubber or plastic).

j. Full-Body Protection. Full-body protection is required when there is a potential for bodily injury from, to include but not limited to, radiation, temperature extremes (air or water), hot splashes from molten metals and other hot liquids, impacts from tools, machinery, or materials, or hazardous chemicals or substances. (5-8.j)

(1) Select appropriate body protection based on an evaluation of the performance characteristics of the body protection relative to the task(s) to be performed, conditions present, duration of use, and the hazards and potential hazards identified. Employers must ensure that their employees wear PPE only for the parts of the body exposed to possible injury. Examples of body protection include laboratory coats, coveralls, vests, jackets, aprons, surgical gowns, and full body suits. Working near or over the water, protection may include full body anti-exposure suit or dry suit with PFD.

(2) Protective clothing comes in a variety of materials, each effective against particular hazards, such as:

(a) Paper-like fiber disposable suits provide protection against dust and splashes.

(b) Treated wool and cotton adapts well to changing temperatures, is comfortable, and fire-resistant and protects against dust, abrasions, and rough and irritating surfaces.

(c) Duck is a closely woven cotton fabric that protects against cuts and bruises when handling heavy, sharp, or rough materials.

(d) Leather is often used to protect against dry heat and flames.

(e) Rubber, rubberized fabrics, neoprene, and plastics protect against certain chemicals and physical hazards.

(f) Check with the clothing manufacturer to ensure the material selected will protect against the specific hazard. Manufacturer information must be available onsite.

(g) Chemicals with designations “prevent skin contact” or “skin” indicate there is a potential dermal hazard. For situations where direct skin contact may occur, chemical protective clothing providing resistance to permeation, penetration, and degradation is recommended.

(3) Protective leg chaps made of cut-resistant material must be worn by workers who operate chainsaws. Protective leg chaps must meet the specifications in ASTM F1897.

(4) For personal fall protection equipment, including lineman's equipment (electrically rated harnesses), see chapter 21.

(5) If a hazard assessment indicates a need for full body protection against toxic substances or harmful physical agents, the clothing should be carefully inspected before each use, it must fit each worker properly, and it must function properly and for the purpose for which it is intended.

k. Electrical Protective Equipment. Electrical protective equipment (for example, tools, PPE) is required when persons perform work that involves exposure to electrical hazards. (5-8.k)

(1) Inspect, test, and maintain all electrical protective equipment in safe conditions according to the manufacturer's instructions and table 5-7 (see para 5-5).

(a) Perform an air test on rubber insulating gloves before each use.

(b) Perform periodic electrical tests on rubber insulating gloves before first issue and every 6 months thereafter.

(c) Perform periodic electrical tests on rubber insulating blankets and sleeves before first issue and every 12 months thereafter, or when the insulating value is suspect (rubber insulating covers) according to 29 CFR 1910.137.

(2) Employees must use electrical protective gloves, sleeves, blankets, covers and line hoses as required by special conditions for work on energized components. Rubber goods provided to protect employees who work on energized components must meet ASTM Committee F18 standards or equivalent as determined by the Authority Having Jurisdiction (AHJ) (see chapter 11).

(3) Protective clothing and other PPE must be provided for any person entering the arc flash protection boundary and the limited approach boundary based on the electrical hazard risk assessment (see chapter 11).

(a) Do not wear synthetic clothing (for example, acetate, nylon, polyester, rayon), either alone or in blends with cotton while in the arc flash protection boundary.

(b) Employees must wear protective eye equipment when identified within the electrical hazard assessment.

(c) Employees must wear arc-rated clothing whenever they may be exposed to potentially energized components (see table 5-8).

(c-1) Arc-rated suits and their closure design must allow easy and rapid removal.

(c-2) The entire arc-rated suit, including the window, must have energy-absorbing characteristics suitable for arc flash exposure.

(c-3) Clothing and equipment required by the degree of electrical hazard exposure can be worn alone or be integrated with normal apparel.

(c-4) Protective clothing and equipment must cover associated parts of the body and all normal apparel that is not flame-resistant, while allowing movement and visibility.

(d) Employees must wear rubber-insulating gloves where there is a danger of hand or arm injury from electric shock or arc flash burns due to contact with energized components. Gloves made from layers of flame-resistant material provide the highest level of protection. Leather glove protectors should be worn over voltage-rated rubber gloves.

(4) Dielectric footwear is required where step and touch potential protection is necessary based on the electrical hazard assessment.

(5) Protective equipment of material other than rubber must provide equal or better electrical and mechanical protection

(6) Other protective equipment needed when performing electrical work (for example, insulated tools, fuse or fuse holder handling equipment, temporary protective grounds (TPG), fiberglass rods, ladders, protective, rubber insulation and guard equipment) must be manufactured to meet the standard specifications listed in NFPA 70E. Test all protective equipment using the standard testing methods listed in NFPA 70E.

(7) Only live-line tool poles having a manufacturer's certification to withstand at least the following test may be used: 100 (kilovolts) kV AC per ft (305 mm) of length for 5 minutes or 75 kV AC per ft (305 mm) for fiberglass-reinforced plastic (FRP) tools. Maintain records for all live-line tools to demonstrate satisfactory accomplishment of laboratory and shop test.

(8) Wooden tools are not authorized for use.

(9) When using live-line tools, workers must use voltage rated gloves and not place their hands closer than necessary to energized conductors or to the metal parts of the tool.

(10) Use only tools and equipment intended for live-line bare hand work on transmission lines. The tools must be kept dry and clean and must be visually inspected before use each day.

(11) Tools must be insulated and manufactured to meet ASTM F18. The insulating portion of tool must be made of FRP.

(12) Tools must be insulated and manufactured to meet ASTM standards as referenced in table 5-7 or equivalent as determined by the AHJ.

I. Lifesaving Skiffs. A skiff ensures prompt rescue of employees that fall into the water, regardless of other precautions taken to prevent this from occurring. A skiff supplies a backup to potential failures of fall protection devices, the use of fall protection systems is not a substitute for the skiff. (5-8.I)

(1) Lifesaving and/or safety skiffs are required during construction activities where work is performed over or immediately next to water irrespective of the fall protection provided. During any operations and maintenance activities that cause an employee to work outside the designated permanently installed safety controls (that is, guardrails) at least one lifesaving skiff should be immediately available.

(2) Provide personnel trained in launching and operating the skiff readily available during working hours. Lifesaving personnel must perform a lifesaving drill to include the launching and recover of the skiff before the initiation of work at the site and periodically thereafter as specified by the USACE supervisor/KO or COR (at least monthly or whenever new personnel are involved). (See paragraph 5-3)

(3) An employer must have a lifesaving skiff available that could, at the minimum, retrieve an employee from the water no more than three to four minutes from the time they entered the water. However, if there are any additional hazards, such as very cold water, rapids an employee could be swept into, etc., the lifesaving skiff would have to be able to retrieve an employee before they sustained injuries because of those additional hazards.

Note. If the water is so shallow that rescuers could simply run in (and a skiff would foul on the bottom anyway), a skiff may not be required.

(4) Required equipment onboard must meet or exceed USCG requirements and the requirements of chapter 19 of this manual. Skiffs must be equipped as follows:

- (a) Four (4) oars, or two (2) if the skiff is motor powered.
- (b) Oarlocks attached to gunwales or the oars.
- (c) One (1) ball-pointed boat hook.
- (d) One (1) ring buoy with 60 feet (18.3 m) of three-eighths (3/8) inch (1 cm) solid braid polypropylene, or equivalent, line attached.
- (e) PFDs in number equaling the skiff rating for the maximum number of personnel allowed on board.
- (f) Fire extinguisher.

(5) In locations where waters are rough or swift, or where manually operated boats are not practical, provide a power boat suitable for the waters and equip it for lifesaving.

(6) Skiffs and power boats must have buoyant material capable of floating the boat, its equipment, and the crew.

(7) Vessels without permanently mounted navigation lights (for example, skiffs), must be equipped with portable battery-operated navigation lights and use them during night operations.

(8) Provide additional skiffs as necessary based on the task, hazards, availability, etc.

5-9. Figures and Tables.

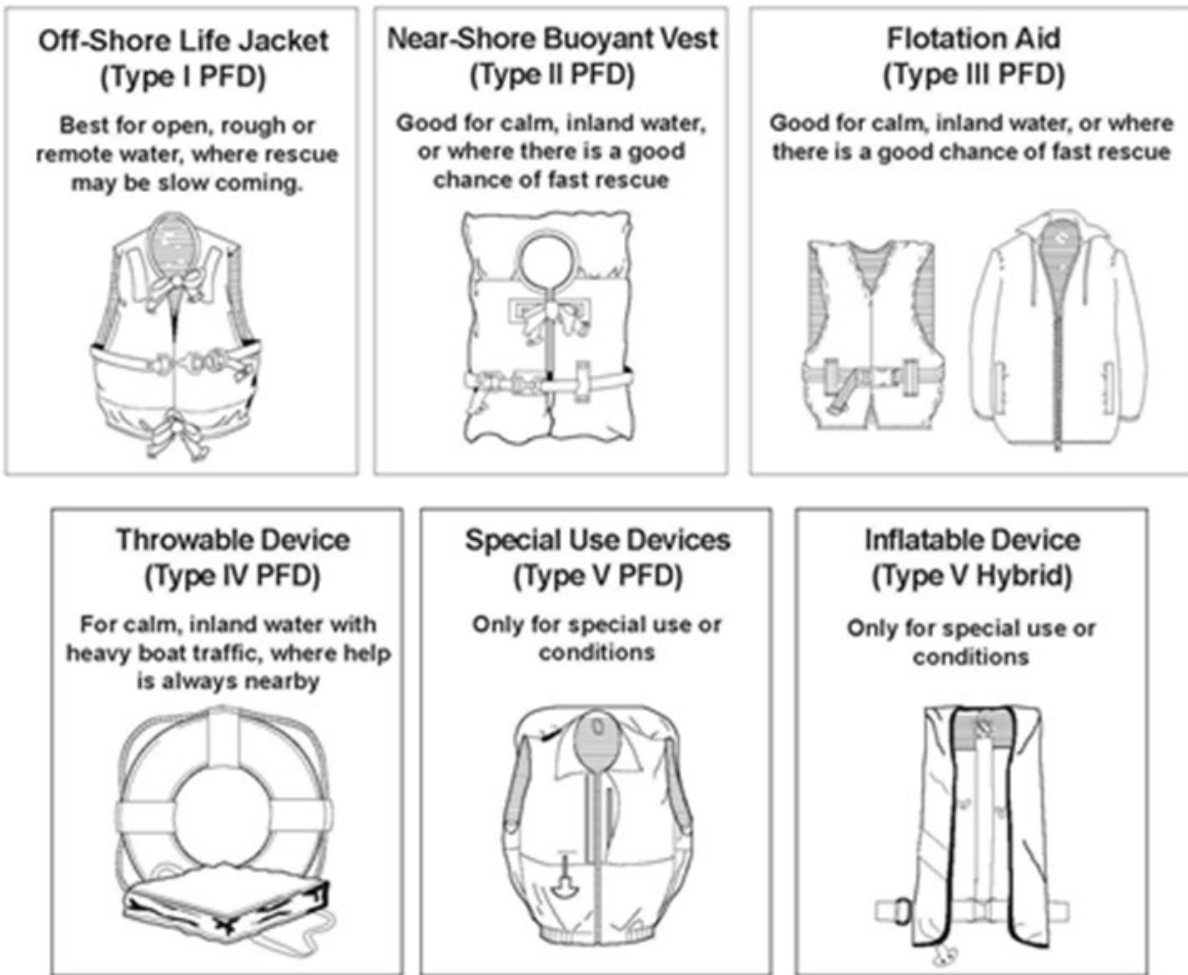

Figure 5-1. Personal Flotation Devices (PFD)

Table 5-1

Eye and Face Protector Section Guide

Hazard	Protectors	Limitations	Marking ¹
IMPACT - Chipping, grinding, machining, masonry work, riveting, and sanding			
Flying fragments, objects, large chips, particles, sand, dirt, etc.	<ul style="list-style-type: none"> • Spectacles with side protection • Goggles with direct or indirect ventilation • Face shield worn over spectacles or goggles • Welding helmet worn over spectacles or goggles • Loose-fitting respirator worn over spectacles or goggles • Full-facepiece respirators 	<p>Caution should be exercised in the use of metal frame protective devices in electrical hazard areas. Metal frame protective devices could potentially cause electrical shock and electrical burn through contact with, or thermal burns from exposure to the hazards of electrical energy, which include radiation from accidental arcs.</p> <p>To provide adequate protection, ensure goggles fit tightly to the face.</p> <p>Atmospheric conditions and the restricted ventilation of a protector can cause lenses to fog. Frequent cleaning may be required.</p>	Impact rated: + (spectacle lens) Z87+ (all other lens) Z87+ (plano frame) Z87-2+ (Rx frame)
HEAT - Furnace operations pouring, casting, hot dipping, gas cutting, and welding			
Hot sparks	<ul style="list-style-type: none"> • Spectacles with side protection • Goggles with direct or indirect ventilation • Face shield worn over spectacles or goggles • Loose-fitting respirator worn over spectacles • Full-facepiece respirator 	<p>Spectacles, cup, and cover type goggles do not provide unlimited facial protection.</p> <p>Operations involving heat may also involve optical radiation. Protection from both hazards must be provided.</p>	<p><i>Note.</i> There are currently no marking designations for eye protection to heat or high-temperature exposure in the ANSI/ISEA Z87.1 standard.</p>

**Table 5-1
Eye and Face Protector Section Guide — Continued**

Hazard	Protectors	Limitations	Marking ¹
Splash from molten metal	<ul style="list-style-type: none"> • Face shield worn over goggles • Loose-fitting respirator worn over spectacles or goggles • Full-facepiece respirator 	Lens mounting must be able to retain in position all parts of a cracked lens.	
High temperature exposure	<ul style="list-style-type: none"> • Screen face shield over spectacles or goggles • Reflective face shield over spectacles or goggles 		
CHEMICAL - Liquids, acid and chemical handling, degreasing, plating.			
Splash, droplets, and sprays	<ul style="list-style-type: none"> • Goggles with indirect ventilation (eyecup or cover type) • Face shield worn over goggles) • Loose-fitting respirator worn over spectacles or goggles • Full-facepiece respirator 	Atmospheric conditions and the restricted ventilation of a protector can cause lenses to fog. Frequent cleaning may be required. To provide adequate protection, ensure goggles fit tightly to the face.	Splash/droplet: D3
Irritating Mist	<ul style="list-style-type: none"> • Goggle with no ventilation (cover type) • Face shield worn over goggles • Loose-fitting respirator worn over spectacles or goggles • Full-facepiece respirator 	Atmospheric conditions and the restricted ventilation of a protector can cause lenses to fog. Frequent cleaning may be required. To provide adequate protection, ensure goggles fit tightly to the face.	<i>Note.</i> There are currently no marking designations for eye protection to irritating mists exposure in the ANSI/ISEA Z87.1 <u>2020</u> standard.

**Table 5-1
Eye and Face Protector Section Guide — Continued**

Hazard	Protectors	Limitations	Marking ¹
DUST - Woodworking, buffing, general dusty conditions			
Nuisance dust	<ul style="list-style-type: none"> • Goggles with direct or indirect ventilation (eyecup or cover type) • Full-facepiece respirator 	<p>Atmospheric conditions and the restricted ventilation of a protector can cause lenses to fog. Frequent cleaning may be required.</p> <p>To provide adequate protection, ensure goggles fit tightly to the face.</p>	Dust: D4
Fine dust	<ul style="list-style-type: none"> • Goggles with indirect ventilation or no ventilation • Full-facepiece respirator 	<p>To provide adequate protection, ensure goggles fit tightly to the face.</p>	Fine dust: D5
OPTICAL RADIATION			
Infrared Radiation (IR)	<ul style="list-style-type: none"> • Spectacles with side protection • Goggles with direct or indirect ventilation • Face shield worn over spectacles or goggles • Welding helmet worn over spectacles or goggles • Loose-fitting respirator worn over spectacles or goggles • Full-facepiece respirators 	<p>For proper fit of protector; there must be no penetration of direct infrared spectra light in all non-lens areas.</p> <p>Side shields must have filtering capability equal to or greater than the front lenses.</p>	IR: R and scale number

**Table 5-1
Eye and Face Protector Section Guide — Continued**

Hazard	Protectors	Limitations	Marking ¹
Visible Light (Glare)	<ul style="list-style-type: none"> • Spectacles with side protection (UVA and UVB 99% filtration) • Goggles with direct or indirect ventilation • Face shield worn over spectacles or goggles • Welding helmet worn over spectacles or goggles • Loose-fitting respirator worn over spectacles or goggles • Full-facepiece respirators 	<p>For proper fit of protector; there must be no penetration of direct visible light in all non-lens areas.</p> <p>Side shields must have filtering capability equal to or greater than the front lenses.</p>	Visible: L and scale number
Ultraviolet (UV) Radiation	<ul style="list-style-type: none"> • Spectacles with side protection (<u>UVA and UVB 99% filtration</u>) • Goggles with direct or indirect ventilation • Face shield worn over spectacles or goggles • Welding helmet worn over spectacles or goggles • Loose-fitting respirator worn over spectacles or goggles • Full-facepiece respirators 	<p>For proper fit of protector; there must be no penetration of direct UV light in all non-lens areas.</p> <p>Side shields must have filtering capability equal to or greater than the front lenses.</p>	UV: U and scale number

**Table 5-1
Eye and Face Protector Section Guide — Continued**

Hazard	Protectors	Limitations	Marking ¹
Lasers	Refer to ANSI/LIA Z136.1 for guidance in choosing the correct protective eyewear when working with lasers.		<i>Note.</i> There are currently no marking designations for eye protection to lasers in the ANSI/ISEA Z87.1 standard.
Electric Arcs	Refer to NFPA 70E “Standard for Electrical Safety in the Workplace”, for guidance in choosing the correct protective eyewear when working on electrical equipment.	Only face shields provide compliant eye and face protection, worn over protective spectacles.	<i>Note.</i> There are currently no marking designations for eye protection to electrical arcs in the ANSI/ISEA Z87.1 standard.
<p>Arc Welding: Arc Process Examples:</p> <p>Shielded Metal Arc Welding (SMAW)</p> <p>Gas Metal Arc Welding (GMAW)</p> <p>Gas Tungsten Arc Welding (GTAW)</p> <p>Air Carbon Arc Welding (CACA)</p> <p>Carbon Arc Welding (CAW)</p> <p>Plasma Arc Welding (PAW)</p> <p>Plasma Arc Cutting (PAC)</p> <p>Viewing electric arc</p>	<ul style="list-style-type: none"> • Welding helmet over spectacles or goggles • Face shield over spectacles or goggles • Respirator (if required by AHA) <p>TYPICAL FILTER LENS SHADE: 10-14</p>	<p>Protection from optical radiation is directly related to filter lens density. Select the darkest shade that allows adequate task performance.</p> <p>For proper fit of protector; there must be no penetration of direct visible light in all non-lens areas.</p> <p>Side shields must have filtering capability equal to or greater than the front lenses.</p> <p>Welding helmets are intended to shield the eyes and face from optical radiation, heat, and impact. Welding helmets should not be used as stand-alone protective devices and should be worn in conjunction with goggles or spectacles.</p>	<p>Welding: W shade number</p> <p>UV: U scale number</p> <p>IR: R scale number</p> <p>Variable tint: V</p> <p>Special purpose: S</p>

**Table 5-1
Eye and Face Protector Section Guide — Continued**

Hazard	Protectors	Limitations	Marking ¹
furnaces and boilers.	<ul style="list-style-type: none"> • 	<p>Filter lens shade selection is to be made based on the welding process, arc current, electrode size and/or plate thickness. Use ANSI Z49.1:2012, table 1, Guide for Shade Numbers, to select the proper filter lens shade for both protection and comfort (reduction in visible glare).</p> <p><i>Note.</i> Filter lenses must meet the requirements for shade designations in table 7 of ANSI/ISEA Z87.1-2020.</p>	
<p>Oxyfuel Gas Welding:</p> <p>Process Examples:</p> <p>Oxyfuel Gas Welding (OFW)</p> <p>Viewing gas-fired furnaces and boilers</p>	<ul style="list-style-type: none"> • Welding goggles • Welding helmet over spectacles or goggles • Welding face shield over spectacles or goggles <p>TYPICAL FILTER LENS SHADE: 6 -8</p>	<p>Protection from optical radiation is directly related to filter lens density. Select the darkest shade that allows adequate task performance.</p> <p>For proper fit of protector; there must be no penetration of direct visible light in all non-lens areas.</p>	<p>Welding: W shade number</p> <p>UV: U scale number</p> <p>Visible: L scale number</p> <p>IR: R scale number</p> <p>Variable tint: V</p>
Oxyfuel or Oxygen Cutting	<ul style="list-style-type: none"> • Welding goggles • Welding helmet over spectacles or goggles • Welding face shield over spectacles or goggles <p>TYPICAL FILTER LENS SHADE:3-6</p>	<p>Side shields must have filtering capability equal to or greater than the front lenses.</p> <p>Welding helmets are intended to shield the eyes and face from optical radiation, heat,</p>	<p>Special purpose: S</p>

**Table 5-1
Eye and Face Protector Section Guide — Continued**

Hazard	Protectors	Limitations	Marking ¹
	<ul style="list-style-type: none"> • 	<p>and impact. Welding helmets should not be used as stand-alone protective devices and should be worn in conjunction with goggles or spectacles.</p> <p>Filter lens shade selection is to be made based on the welding process, arc current, electrode size and/or plate thickness. Use ANSI Z49.1: 2012, table 1, Guide for Shade Numbers, to select the proper filter lens shade for both protection and comfort (reduction in visible glare).</p> <p><i>Note.</i> Filter lenses must meet the requirements for shade designations in table 7 of ANSI/ISEA Z87.1-2020.</p>	
Torch brazing	<ul style="list-style-type: none"> • Welding goggles • Welding helmet over spectacles or goggles • Welding face shield over spectacles or goggles • TYPICAL FILTER LENS SHADE: 3-4 		
Torch soldering	<ul style="list-style-type: none"> • Spectacles Welding face shield over spectacles • TYPICAL FILTER LENS SHADE: 2 	<p>Shade or special purpose lenses, as suitable.</p> <p><i>Note.</i> Refer to definition of special purpose lenses in ANSI/ISEA Z87.1.</p>	

**Table 5-1
Eye and Face Protector Section Guide — Continued**

Hazard	Protectors	Limitations	Marking ¹
Glare	<ul style="list-style-type: none"> Spectacles with or without side protection Face shield over spectacles or goggles. 		

*Table 8-9.b is as excerpted from ANSI/ISEA Z87.1, Occupational and Educational Personal Eye and Face Protection Devices Annex J.

1. Refer to ANSI/ISEA Z87.1 table 3 for complete marking requirements.
2. Refer to ANSI Z49.1: "Safety in Welding, Cutting, and Allied Processes", Guide for Shade Numbers, to select the proper lens filter protective shade based on welding process, arc current (in amperes), Electrode Size (arc welding only) and metal plate thickness (for oxyfuel and oxygen cutting only).
3. Refer to ANSI/LIA Z136.1 "Safe Use of Lasers", for guidance on choosing the correct protective eyewear when working with lasers.

**Table 5-2
Required Shades for Filter Lenses/Glasses in Welding, Cutting, Brazing and Soldering**

OPERATION	SHADE NUMBER
Soldering	2
Torch Brazing	3 or 4
<u>Oxygen</u> Cutting (light) up to 1 inch (2.5 cm)	3 or 4
<u>Oxygen</u> Cutting (medium) 1 to 6 inches (2.5 to 15.2 cm)	4 or 5
<u>Oxygen</u> Cutting (heavy) 6 inches (15.2 cm) or more	5 or 6
<u>Oxyfuel</u> Gas welding (light) up to 1/8 inch (0.3 cm)	4 or 5
<u>Oxyfuel</u> Gas welding (medium) 1/8 to 1/2 inch (0.3 to 1.3 cm)	5 or 6
<u>Oxyfuel</u> Gas welding (heavy) 1/2 inch (1.3 cm) or more	6 or 8
Atomic hydrogen welding	10 – 14
Inert-gas metal-arc welding (nonferrous): 1/16 inch to 5/32 inch (0.2 to 0.4 cm) electrodes	11
Inert-gas metal-arc welding (ferrous): 1/16 to 5/32 inch (0.2 to 0.4 cm) electrodes	12
Shielded metal-arc welding: 3/32 to 5/32 inch (0.1 to 0.4 cm) electrodes	10
Shielded metal-arc welding: 5/32 to 1/4 inch (0.4 to 0.6 cm) electrodes	12

Table 5-2**Required Shades for Filter Lenses/Glasses in Welding, Cutting, Brazing and Soldering — Continued**

OPERATION	SHADE NUMBER
Shielded metal-arc welding: <u>More than 1/4 inch</u> (0.6 cm) electrodes	14
Carbon arc welding	14
Plasma arc cutting up to 100 amps	8
Plasma arc cutting 100 to 200 amps	10
Plasma arc cutting 200 to 400 amps	12
Plasma arc cutting greater than 400 amps	14

Note:

Operations where protection from radiant energy with moderate reduction of visible light is necessary (for example, welding, cutting, brazing, soldering) require eye and face protection suitable to the type of work, providing protection from all angles of direct exposure, and with lenses of the appropriate shade.

Table 5-3**Settings for Noise Measuring Equipment**

Feature	Noise Dosimeter (ACGIH and USACE)	Type 2 (or better) Sound Level Meter for Continuous Noise (USACE)*	Type 1 Sound Level Meter for Impulse Noise (USACE)*
Criterion Time	8 hours	8 hours	8 hours
Criterion Level	85 dB	85 dB	85 dB
Weighting	A	A	<u>C (preferred)</u> or Z
Peak Weighting	<u>Z</u>	Z	<u>C (preferred)</u> or Z
Threshold Level	80 dB	80 dB	<u>80 dB</u>
Upper bound on integration	<u>140 dB</u>	140 dB	<u>140 dB</u>
Time Weighting	Slow	Slow	<u>Fast</u>
Exchange Rate	<u>3 dB</u>	3 dB	3 dB

Note:

When used for the purposes of delineating noise hazardous areas or evaluating noise exposures to personnel.

Table 5-4
Continuous Noise Exposures (ACGIH TLV)

Duration per day (hours)	Permissible sound-pressure level (dBA)
12	83
10	84
8	85
4	88
2	91
1	94
0.5 = 30 min	97
0.25 = 15 min	100

Table 5-5
Hand and Arm Protection

Type	Uses	Limitations	Applications
Cotton or cloth <u>gloves</u>	<ul style="list-style-type: none"> Prevent small scratches. Can be used as a lining to prevent perspiration if placed under other gloves. Protects against the handling of light materials. 	<ul style="list-style-type: none"> Do not offer a <u>high level of protection (thin layer)</u>. Do not prevent burns or cuts. 	<ul style="list-style-type: none"> Handling fragile objects.
Fabric and coated fabric gloves	<ul style="list-style-type: none"> Protect against dirt, slivers, chafing and abrasions. Protection against certain moderately concentrated <u>chemicals</u>. Coated gloves can offer slip-resistant qualities. 	<ul style="list-style-type: none"> Do not provide <u>sufficient protection for use with rough, sharp, or heavy materials</u>. Do not protect the entire hand from chemicals. 	<ul style="list-style-type: none"> Tasks ranging from handling bricks and wire rope to handling <u>chemical containers</u>.
Metal mesh gloves	<ul style="list-style-type: none"> Provide protection against <u>punctures and cuts</u>. 	<ul style="list-style-type: none"> Do not protect against power-driven blades, saws, and tools. Cannot be used near electrical distribution systems or equipment. 	<ul style="list-style-type: none"> Sheet metal <u>applications</u>. Using hand knives or blades.
Leather gloves	<ul style="list-style-type: none"> Resistant to sparks and <u>moderate heat</u>. Protects against abrasions from rough objects. 	<ul style="list-style-type: none"> Poor protection against liquids. Limited protection against cuts and punctures. 	<ul style="list-style-type: none"> Welding work. General purpose.

**Table 5-5
Hand and Arm Protection — Continued**

Type	Uses	Limitations	Applications
Butyl rubber gloves	<ul style="list-style-type: none"> Protect against corrosive acids and bases, <u>ketones</u>, and <u>esters</u>. Resists oxidation, ozone corrosion, abrasion and remain flexible at low temperatures. 	<ul style="list-style-type: none"> Do not protect against aromatic or aliphatic <u>hydrocarbons (for example, gasoline, diesel fuel, kerosene, turpentine)</u>. 	<ul style="list-style-type: none"> Cleaning <u>applications</u>.
Natural latex or rubber gloves	<ul style="list-style-type: none"> Resistant to chemicals, oils, solvents, and microorganisms. Offer dexterity for precision work. Strong dry grip. Abrasion resistant. 	<ul style="list-style-type: none"> Many people are allergic to latex. Provides limited range of <u>mechanical protection</u>. 	<ul style="list-style-type: none"> Medical applications. Cleaning. Chemical handling. General purpose.
Neoprene rubber gloves	<ul style="list-style-type: none"> Good pliability, dexterity, high density, and <u>tear resistance</u>. Provide protection from hydraulic fluids, gasoline, alcohols, <u>organic acids</u>, and <u>alkalis</u>. Cold water resistant. 	<ul style="list-style-type: none"> Poor for halogenated and aromatic hydrocarbons. Less effective against mechanical risks. Not very resistant to aromatic <u>solvents</u>. 	<ul style="list-style-type: none"> Automotive. Chemical and industrial cleaning. Water related activities and colder wet environments.
Nitrile rubber gloves	<ul style="list-style-type: none"> Provide protection from chlorinated solvents such as trichloroethylene and perchloroethylene. Resists <u>abrasion</u>, <u>puncturing</u>, <u>snagging</u>, and <u>tearing</u>. Good alternative to latex. 	<ul style="list-style-type: none"> Not <u>resistant to ketones and halogen products</u>. 	<ul style="list-style-type: none"> Wet or greasy environments. Food handling. Automotive industries. Jobs requiring dexterity and sensitivity.
Anti-vibration gloves	<ul style="list-style-type: none"> Reduce high frequency vibration from tools like grinders, sanders, <u>saws</u>. 	<ul style="list-style-type: none"> Often do not protect against low frequency vibrations (e. g., chisels and pavement breakers). May limit dexterity and grip. 	<ul style="list-style-type: none"> Operating vibrating <u>equipment or tools</u>.

Note:
When selecting chemical-resistant gloves be sure to consult the manufacturer's recommendations, especially if the gloved hand(s) will be immersed in the chemical.

**Table 5-6
Hand and Arm Protection Cut Resistance Levels**

ANSI/ISEA Cut Resistance Level	Typical Tasks
A1 Very light cut hazards.	Nuisance cut hazards, small parts assembly, product inspection and QC. Provide very limited protection against cutting hazards.
A2-A3 Light/Medium cut hazards	General purpose, light material handling, warehousing, small parts assembly (sharp edges), packaging, construction.
A4-A6 Medium/High cut hazards	Manufacturing, sheet metal handling, drywall work, electrical, carpet installation, heating, ventilation, and air conditioning (HVAC) assembly/installation/maintenance, light sheet metal stamping, automotive, construction framing, glass handling, machining.
A7-A9 High/Extreme cut hazards	Metal fabrication, industrial blade maintenance and changing, automotive assembly, metal stamping, recycling plant/sorting. Assembly of large, bulky, or heavy objects with sharp edges and/or difficult to grip.

**Table 5-7
Standards for Electrical Personal Protective Equipment**

SUBJECT	STANDARD DOCUMENT INFORMATION
Arc Rated Apparel	ASTM F1506
Arc Rated Face Protection	ASTM F2178/F2178M
Arc Rated Gloves	ASTM F2675/F2675M
Arc Rated Rainwear	ASTM F1891
Arc Rated and Flame-Resistant Apparel Care	ASTM F1449
	ASTM F2757
Dielectric Footwear	ASTM F1117
	ASTM F1116
Insulating Aprons	ASTM F2677
Insulating Gloves and Leather Protectors	ASTM D120
	ASTM F696
Insulating Sleeves	ASTM D1051
Insulating PPE Care and Inspection	ASTM F496
	ASTM F1236

**Table 5-8
Arc Flash Personal Protective Equipment**

Arc-Flash PPE Category	PPE
1	<p>Arc-Rated Clothing, Minimum Arc Rating of 4 cal/cm² (see note 1)</p> <p>Arc-rated long-sleeve shirt and pants or arc-rated coverall</p> <p>Arc-rated face shield (see note 2) or arc flash suit hood</p> <p>Arc-rated jacket, parka, high-visibility safety apparel, rainwear, or hard hat liner (optional) (see note 6)</p> <p>Hard hat; Safety glasses/goggles (S); Ear canal inserts (see note 3); Heavy-duty leather gloves (see note 4); Leather footwear (optional) (see note 5)</p>
2	<p>Arc-Rated Clothing, Minimum Arc Rating of 8 cal/cm² (see note 1)</p> <p>Arc-rated long-sleeve shirt and pants or arc-rated coverall</p> <p>Arc-rated flash suit hood or arc-rated face shield (see note 2) and arc-rated balaclava</p> <p>Arc-rated jacket, parka, high-visibility safety apparel, rainwear, or hard hat liner (optional) (see note 6)</p> <p>Hard hat; Safety glasses/goggles (S); Ear canal inserts (see note 3); Heavy-duty leather gloves (see note 4); Leather footwear (see note 5)</p>
3	<p>Arc-Rated Clothing selected so the System Arc Rating meets the required minimum arc rating of 25 cal/cm² (see note 1)</p> <p>Arc-rated long-sleeve shirt (A)</p> <p>Arc-rated pants (A)</p> <p>Arc-rated coverall (A)</p> <p>Arc-rated arc flash suit jacket (A)</p> <p>Arc-rated arc flash suit pants (A)</p> <p>Arc-rated arc flash suit hood</p> <p>Arc-rated gloves (see note 4)</p> <p>Arc-rated jacket, parka, high-visibility apparel, rainwear, or hard hat liner (optional) (see note 6)</p> <p>Hard hat; Safety glasses/goggles (S); Ear canal inserts (see note 3); Leather footwear (see note 5)</p>

**Table 5-8
Arc Flash Personal Protective Equipment (PPE) — Continued**

Arc-Flash PPE Category	PPE
4	<p>Arc-Rated Clothing selected so the System Arc Rating meets the required minimum Arc Rating of 40 cal/cm² (see note 1)</p> <p>Arc-rated long-sleeve shirt (A)</p> <p>Arc-rated pants (A)</p> <p>Arc-rated coverall (A)</p> <p>Arc-rated arc flash suit jacket (A)</p> <p>Arc-rated arc flash suit pants (A)</p> <p>Arc-rated arc flash suit hood</p> <p>Arc-rated gloves (see note 4)</p> <p>Arc-rated jacket, parka, high- visibility apparel, rainwear, or hard hat liner (optional) (see note 6)</p> <p>Protective Equipment: Hard hat; Safety glasses/goggles (S); Ear canal inserts (see note 3); Leather footwear (see note 5)</p>

A = as required. S = selection required.

Notes:

- ¹ Arc rating is the lower value of either the ATPV or EBT defined in ASTM F1959.
- ² Face shields must have wrap-around guarding to protect the face including forehead, ears, and neck.
- ³ Other types of hearing protection are permitted to be used instead of or in addition to ear canal inserts provided they are worn under an arc-rated arc flash suit hood.
- ⁴ If rubber insulating gloves with leather protectors provide arc flash protection in addition to shock protection. Higher class rubber insulating gloves with leather protectors, due to their increased material thickness, provide increased arc flash protection.
- ⁵ Footwear other than leather or dielectric must be permitted to be used provided it has been tested to demonstrate no ignition, melting, or dripping at the minimum arc rating for the respective arc flash PPE category.
- ⁶ The arc rating of outer layers worn over arc-rated clothing as protection from the elements or for other safety purposes, and that are not used as part of a layered system, must not be required to be equal or greater than the estimated IE exposure.

5-10. Checklists and Forms.

Not Applicable.

Chapter 6 Hazardous or Toxic Agents and Environments

6-1. References.

- a. ACGIH, Threshold Limit Values (TLV) and Biological Exposure Indices (BEI) (<https://www.acgih.org/publications/>) (6-1.a)
- b. American Industrial Hygiene Association (AIHA), Indoor Air Quality (<https://www.aiha.org/public-resources/air-quality>) (6-1.b)
- c. ANSI/ ASA S2.70, Measurement and Evaluation of Human Exposure to Vibration Transmitted to the Hand (<https://webstore.ansi.org/>) (6-1.c)
- d. ANSI/ASA S2.73, Mechanical Vibration and Shock – Hand-Arm Vibration – Measurement and Evaluation of the Vibration Transmissibility of Gloves at the Palm of the Hand (<https://webstore.ansi.org/>) (6-1.d)
- e. ANSI/ASSP Z9.4, Abrasive-Blasting Operations - Ventilation and Safe Practices for Fixed Location Enclosures (<https://webstore.ansi.org/>) (6-1.e)
- f. ANSI/ISEA Z358.1, Emergency Eyewash and Shower Equipment (<https://webstore.ansi.org/>) (6-1.f)
- g. AR 50-6, Chemical Surety (https://armypubs.army.mil/epubs/DR_pubs/DR_a/ARN32351-AR_50-6-000-WEB-1.pdf) (6-1.g)
- h. AR 385-10, The Army Safety and Occupational Health Program (<https://armypubs.army.mil/ProductMaps/PubForm/AR.aspx>) (6-1.h)
- i. DA Pam 40-501, The Army Hearing Program (<https://armypubs.army.mil/ProductMaps/PubForm/PAM.aspx>) (6-1.i)
- j. DA Pam 40-503, The Army Industrial Hygiene Program (<https://armypubs.army.mil/ProductMaps/PubForm/PAM.aspx>) (6-1.j)
- k. DoDI 6055.11, Protecting Personnel from Electromagnetic Fields (<https://www.esd.whs.mil/directives/issuances/dodi/>) (6-1.k)
- l. DTR 4500.9-R, chapter 204 Hazardous Material (https://www.ustranscom.mil/dtr/part-ii/dtr_part_ii_204.pdf) (6-1.l)
- m. EM 385-1-80, Ionizing Radiation Protection Manual (https://www.publications.usace.army.mil/Portals/76/Publications/EngineerManuals/EM_385-1-80.pdf?ver=9Z52MMPJXnB7-Q07cyIPQQ%3d%3d) (6-1.m)

- n. Environmental Protection Agency (EPA) Lead Renovation, Repair and Painting Program
(<https://www.epa.gov/lead/lead-renovation-repair-and-painting-program>) (6-1.n)
- o. EPA IAQ Management Checklist
(<https://www.epa.gov/sites/default/files/2014-08/documents/mgmtlist.pdf>) (6-1.o)
- p. ER 385-1-11, Industrial Hygiene Program
(<https://www.publications.usace.army.mil/LinkClick.aspx?fileticket=WNgg7LkTXZ4%3d&tabid=16441&portalid=76&mid=43546>) (6-1.p)
- q. ER 385-1-96, USACE Ergonomic Program Policy
(<https://www.publications.usace.army.mil/LinkClick.aspx?fileticket=13AXVgmz5Vs%3d&tabid=16441&portalid=76&mid=43546>) (6-1.q)
- r. International Organization for Standardization (ISO) 5349, Mechanical Vibration
(<https://www.iso.org/standards.html>) (6-1.r)
- s. ISO 8662, Hand-Held Portable Power Tools – Measurement of Vibrations at the Handle
(<https://www.iso.org/standards.html>) (6-1.s)
- t. NFPA 400, Hazardous Materials Code
(<https://www.nfpa.org/codes-and-standards/all-codes-and-standards/list-of-codes-and-standards/detail?code=400>) (6-1.t)
- u. TB MED 507, Heat Stress Control and Heat Casualty Management
(https://armypubs.army.mil/ProductMaps/PubForm/TB_Cal.aspx) (6-1.u)
- v. TB MED 508, Prevention and Management of Cold Weather Injuries
(https://armypubs.army.mil/ProductMaps/PubForm/TB_Cal.aspx) (6-1.v)
- w. TB MED 577 NAVMED P-5010-10/AFMAN 48-138 IP, Sanitary Control and Surveillance of Field Water Supplies
(https://armypubs.army.mil/ProductMaps/PubForm/TB_Cal.aspx) (6-1.w)
- x. TG 277, Industrial Hygiene Public Health Army Mold Remediation Guidance
(<https://phc.amedd.army.mil/PHC%20Resource%20Library/TG277FINAL28Feb2019.pdf>) (6-1.x)
- y. TG 278, Industrial Hygiene Public Health Mold Assessment Guide
(<https://phc.amedd.army.mil/PHC%20Resource%20Library/TG278.pdf>) (6-1.y)
- z. OSHA Instruction CPL 2.86, Memorandum of Understanding between the OSHA and the U.S. Nuclear Regulatory Commission (1989)
(<https://www.osha.gov/enforcement/directives/cpl-02-00-086>) (6-1.z)

- aa. UFGS 02 82 00, Asbestos Remediation (<https://www.wbdg.org/ffc/dod/unified-facilities-guide-specifications-ufgs/ufgs-02-82-00>) (6-1.aa)
- bb. UFGS 02 83 00, Lead Remediation (<https://www.wbdg.org/ffc/dod/unified-facilities-guide-specifications-ufgs/ufgs-02-83-00>) (6-1.bb)
- cc. 29 CFR 1910, General Industry (<https://www.osha.gov/laws-regs/regulations/standardnumber/1910>) (6-1.cc)
- dd. 29 CFR 1910.94, Ventilation (<https://www.govinfo.gov/content/pkg/CFR-2022-title29-vol5/pdf/CFR-2022-title29-vol5-sec1910-94.pdf>) (6-1.dd)
- ee. 29 CFR 1910.134, Respiratory Protection (<https://www.govinfo.gov/content/pkg/CFR-2022-title29-vol5/pdf/CFR-2022-title29-vol5-sec1910-134.pdf>) (6-1. ee)
- ff. 29 CFR 1910 Subpart H, Hazardous Materials (<https://www.govinfo.gov/content/pkg/CFR-2022-title29-vol5/pdf/CFR-2022-title29-vol5-part1910-subpartH.pdf>) (6-1.ff)
- gg. 29 CFR 1910 Subpart Z, Toxic and Hazardous Substances (<https://www.govinfo.gov/content/pkg/CFR-2022-title29-vol6/pdf/CFR-2022-title29-vol6-part1910-subpartZ.pdf>) (6-1.gg)
- hh. 29 CFR 1915 Subpart Z, Toxic and Hazardous Substances (<https://www.govinfo.gov/content/pkg/CFR-2022-title29-vol7/pdf/CFR-2022-title29-vol7-part1915-subpartZ.pdf>) (6-1.hh)
- ii. 29 CFR 1926.62, Lead (<https://www.govinfo.gov/content/pkg/CFR-2022-title29-vol8/pdf/CFR-2022-title29-vol8-sec1926-62.pdf>) (6-1.ii)
- jj. 29 CFR 1926.64, Process Safety Management for Highly Hazardous Chemicals (<https://www.govinfo.gov/content/pkg/CFR-2022-title29-vol8/pdf/CFR-2022-title29-vol8-sec1926-64.pdf>) (6-1.jj)
- kk. 29 CFR 1926.65, Hazardous Waste Operations and Emergency Response (<https://www.govinfo.gov/content/pkg/CFR-2022-title29-vol8/pdf/CFR-2022-title29-vol8-sec1926-65.pdf>) (6-1.kk)
- ll. 29 CFR 1926 Subpart Z, Toxic and Hazardous Substances (<https://www.govinfo.gov/content/pkg/CFR-2022-title29-vol8/pdf/CFR-2022-title29-vol8-part1926-subpartZ.pdf>) (6-1.ll)
- mm. 40 CFR 61 Subpart M, National Emission Standard for Asbestos (<https://www.govinfo.gov/content/pkg/CFR-2011-title40-vol8/pdf/CFR-2011-title40-vol8-part61-subpartM.pdf>) (6-1.mm)

nn. 40 CFR 141, National Primary Drinking Water Regulation
(<https://www.govinfo.gov/content/pkg/CFR-2015-title40-vol23/pdf/CFR-2015-title40-vol23-part141.pdf>) (6-1.nn)

oo. 40 CFR 302, Designation, Reportable Quantities, and Notification
(<https://www.govinfo.gov/content/pkg/CFR-2020-title40-vol30/pdf/CFR-2020-title40-vol30-part302.pdf>) (6-1.oo)

6-2. Definitions.

a. **Abrasive Blasting.** The forcible application of an abrasive to a surface by pneumatic pressure, hydraulic pressure, or centrifugal force. (6-2.a)

b. **Acclimatize.** The process or result of becoming accustomed to a new climate or to new conditions. (6-2.b)

c. **Action Level.** Action level means a concentration designated in 29 CFR 1910 for a specific substance, calculated as an eight (8)-hour time-weighted average (TWA), which initiates certain required activities such as exposure monitoring and medical surveillance. Usually the Action Level represents 1/2 of the OEL. (6-2.c)

d. **Asbestos-Containing Material (ACM).** Any material containing more than 1% of asbestos. (6-2.d)

e. **Chemical.** Any substance or mixture of substances. (6-2.e)

f. **Cold Stress.** An umbrella term that refers to cold-related illnesses that occur when the body can no longer maintain its normal temperature. These illnesses range from mild and treatable to permanent tissue damage and death. (6-2.f)

g. **Competent Person (CP).** See paragraphs 1-2 or 2-2, as applicable. (6-2.g)

h. **Exposure or Exposed.** When an employee is subjected in the course of employment to a chemical that is a physical or health hazard. "Subjected" in terms of health hazards includes any route of entry (for example, inhalation, ingestion, skin contact, or absorption). (6-2.h)

i. **Hazardous or Toxic Agent.** To include but not limited to, any substance defined as a hazardous substance under 29 CFR 1910.120 (29 CFR 1910 Subpart H), 29 CFR 1926.65, or 40 CFR 302, any chemical determined to be a hazard as specified in 29 CFR 1910.1200 to include gases, liquid vapors, mists, dusts, or fumes which have been identified as causing adverse health effects in exposed employees, noise and radiation where duration and quantity of exposure is capable of causing adverse health effects, or any agent pertaining to or that may cause poison, be poisonous, or harmful. (6-2.i)

j. Heat Stress. The net heat load to which a worker is exposed. Physical exertion, environmental factors, and clothing worn all contribute to heat stress. (6-2.j)

k. High-Efficiency Particulate Air (HEPA) Filter. A filter capable of trapping and retaining at least 99.97% of 0.3 micrometer diameter mono-disperse particles. (6-2.k)

l. Industrial Hygienist (IH). A scientist or engineer devoted to the anticipation, recognition, evaluation, prevention, and control of those environmental factors or stresses arising in or from the workplace which may cause sickness, impaired health and well-being, or significant discomfort among workers or among the citizens of the community. A Certified Industrial Hygienist (CIH) is a professional credential for this vocation, which is governed by the Board for Global EHS (environmental, health and safety) Credentialing. (6-2.l)

m. Occupational Exposure Limit (OEL). A generic term used to apply to all exposure limits, to include DoD standards such as military exposure guidelines, OSHA permissible exposure limits, ACGIH TLVs, NIOSH Recommended Exposure Limits, and other exposure limits reviewed for potential use. (6-2.m)

n. Potable Water. Water that meets the standards for drinking purposes of the state or local AHJ, or water that meets the quality standards prescribed by the U.S. EPAs National Primary Drinking Water Regulations (40 CFR 141). See also TB MED 577/NAVMED P-5010-10 and NAVMED P-5010-6. (6-2.n)

o. Regulated Area. An area established by the employer to demarcate areas where airborne concentrations of contaminants exceed, or there is a reasonable possibility that they may exceed the OEL. (6-2.o)

p. Rest. A period of time during which the person concerned is off duty, is not performing work, including administrative tasks, and is afforded the opportunity for uninterrupted sleep. This does not include time for breaks, meals, to travel time to/from work. (6-2.p)

q. Safety Data Sheet (SDS). A document that includes information such as the properties of each chemical, the physical, health and environmental health hazards, protective measures, and safety precautions for handling, storing, and transporting the chemical. OSHA requires that SDS preparers provide specific minimum information as detailed in Appendix D of 29 CFR 1910.1200 (29 CFR 1910 Subpart Z). (6-2.q)

r. Thermal Stress. Thermal stress includes both heat and cold stress. These conditions arise when temperatures become too extreme for the body, resulting in a physical response. (6-2.r)

s. Threshold Limit Value (TLV). Airborne concentrations of chemical substances and represent concentrations under which it is believed that nearly all workers may be

repeatedly exposed, day after day, over a working lifetime, without adverse health effects. (6-2.s)

t. Wet-Bulb Globe Temperature Index. A measurement of environmental factors that correlate with human deep body temperature and other physiological responses to heat. (6-2.t)

6-3. Personnel Required Training/Qualification

a. General. At a minimum provide training upon initial assignment and whenever a new hazard is introduced, as applicable. The below training requirements must include the following: (6-3.a)

(1) The specific nature of operations which could result in exposure and effects of exposure.

(2) The specific procedures implemented to protect employees from exposure, such as appropriate engineering controls, work practices, and PPE to be used. Workers must be trained in the removal of personal protective clothing and equipment to prevent further spread or contamination. (See chapter 35)

b. Hazard Communication (HazCom). Provide HazCom training to employees who use or may be exposed to hazardous or toxic agents upon initial assignment and whenever a new hazard is introduced. Training must include the following: (6-3.b)

(1) Requirements of the HazCom Program on the project.

(2) The location of all hazardous or toxic agents at the project.

(3) Identification and recognition of hazardous or toxic agents on the project.

(4) Physical and health hazards of the hazardous or toxic agents pertinent to project activities.

(5) Protective measures employees can implement when working with or around project-specific hazardous or toxic agents.

(6) The location and content of the SDSs for the hazardous or toxic agents.

(7) Procedures for preserving employee exposure records. For USACE ONLY, enter employee exposure records into Defense Occupational Environmental Health Readiness System – Industrial Hygiene (DOEHRS-IH).

(8) Requirements for contractors bringing hazardous materials (HAZMAT) onto USACE projects.

c. Thermal Stress. Provide training to employees exposed to thermal stressors commensurate with job responsibilities to include illnesses and injuries, signs and symptoms, prevention procedures and control measures, and first aid measures. (6-3.c)

d. Fatigue Management. Provide training to employees who perform work hours as identified in paragraph 6-7.j. Training must include symptoms, prevention and controls of fatigue. (6-3.d)

e. Testing and Monitoring Training. Those who perform testing and monitoring of hazardous or toxic agents and environments will follow manufacturer's instructions on the use of monitoring equipment. Review of APPs and contractor's qualifications will determine who can perform testing and monitoring. For USACE operations only, all IH testing and monitoring of USACE employees must be overseen by the District or Division IH and entered into DOEHS-IH. (6-3.e)

f. Hazardous Materials (HAZMAT). Provide training to persons who prepare shipments of HAZMAT as defined by Defense Transportation Regulation (DTR). Such persons must be trained, certified, and issued an appointment letter according to DTR 4500.9-R, chapter 204. (6-3.f)

g. Harmful Plants, Animals, and Insects. Provide training to employees who may be exposed to harmful plants, animals, and insects. Training must include the following as applicable: (6-3.g)

(1) Recognition of the animals and insects and their nesting habits, aggressiveness, potential disease exposure, etc.

(2) Recognition and identification of the plants.

(3) First aid response actions.

h. Exposure Potential Training. The following have different levels of training and certification requirements based on exposure potential and job responsibilities. (6-3.h)

(1) Lead Training. Provide training based on exposure potential according to applicable OSHA/EPA standards.

Note. Individuals performing work in residential houses, apartments, and child-occupied facilities such as schools and day-care centers built before 1978 must comply with EPA training and certification requirements outlined in EPA's Lead-Based Paint Renovation, Repair and Painting Program (RRP).

(2) Asbestos Training. Provide training based on exposure potential according to applicable OSHA/EPA standards.

(3) Beryllium Training. Provide training based on exposure potential according to applicable OSHA standards.

(4) Chromium Training. Provide training based on exposure potential according to applicable OSHA standards.

(5) Abrasive Blasting Training. Provide training based on exposure potential according to applicable OSHA standards.

(6) Respirable Silica. Provide training based on exposure potential according to applicable OSHA standards.

i. Competent Mold Inspector. Assessments/remediations of mold must be overseen by a Competent Mold Inspector with a minimum of five years of experience in evaluation of indoor air concerns and an understanding of the properties of mold behaviors and building design or construction. This person must be an IH, microbiologist, or a qualified indoor air specialist, or mold inspector who has been certified by an independent indoor air quality (IAQ) certifying agency and/or who can demonstrate training and experience in the IAQ investigative field. Some states, local authorities, and host nations also require this person to be licensed. (6-3.i)

6-4. Roles and Responsibilities.

For USACE ONLY, refer to ER 385-1-11, Industrial Hygiene Program.

a. Industrial Hygienist (IH). (6-4.a)

(1) Perform a hazard evaluation of jobsite operations, materials, and equipment that involve potential exposure to hazardous or toxic agents or environments to identify workplace hazards and plans required for implementation (see para 6-8.a).

(2) Review testing and monitoring results to determine the concentration of and any associated hazards of hazardous or toxic agents and environments (see para 6-8.d).

(3) Evaluate activities which could generate airborne contaminants (that is, gases, vapors, fumes, mist, or dusts) to determine potential personnel exposure (see para 6-8.p).

b. Qualified Person (QP). One who because of education, training, or experience, or a combination of these factors can understand the health and environmental risks associated with a chemical substance according to chapters 1 or 2, as applicable. QPs are responsible for overseeing the storage of hazardous chemicals, materials, substances, and wastes prior to transportation. (See para 6-8.e) (6-4.b)

6-5. Inspection Requirements.

a. Testing and Monitoring Equipment. Inspect equipment used for testing and monitoring of hazardous or toxic agents and environments according to the manufacturer's instructions. (6-5.a)

b. Emergency Facilities/Units (Eyewash and Showers). (6-5.b)

(1) Activate plumbed units at least weekly and document to verify proper operation.

(2) Visually inspect and document self-contained units weekly to determine if flushing fluid needs to be changed or supplemented.

(3) Inspect emergency facilities/units annually for compliance with ANSI/ISEA Z358.1 performance requirements.

c. Ventilation Systems. Ventilation systems used to remove hazardous dusts, fumes, gases, or substances must be evaluated at least annually to determine if the system functions as designed. (6-5.c)

d. Blasting Equipment. (6-5.d)

(1) Inspect all blasting PPE and components prior to every use.

(2) The ventilation in all blast enclosures must be measured annually to confirm the flow is adequate and the system does not require cleaning or maintenance.

6-6. Activity Hazard Analysis (AHA) Requirements.

Develop AHAs according to paragraphs 1-6 or 2-6, as applicable. Incorporate applicable information contained in SDSs into AHAs. If a hazardous or toxic agent is used in an operation, attach the SDS to the AHA.

6-7. Minimum Plan Requirements.

a. Hazard Communication (HazCom) Program. A written HazCom Program must be developed when hazardous chemicals are present or used at a project site. The written HazCom program must address the following in project-specific detail: (6-7.a)

(1) Hazardous Chemical Inventory. A list of the hazardous or toxic agents present or used at the project site with the following information. Update the inventory and site map at a minimum, annually, but as frequently as necessary to ensure it is current and accurately reflects those materials onsite.

(a) Explanation of how the agents are used at the project.

(b) For emergency response purposes, identify approximate quantities (for example, liters, kilograms, gallons, pounds) of each agent that is onsite or will be onsite at any given time.

Note. If the agent's name, quantity, and/or location are classified information, maintain in a location so it can be provided to emergency responders during an emergency.

(c) Attach a site map to the inventory showing where substances are stored.

(2) Hazardous or Toxic Agent Labeling. Procedures for assuring containers used to store and transport hazardous or toxic agents around the project site are appropriately labeled to communicate the physical and health hazards associated with the agents in the containers. Labels, at a minimum, must include the information required of the manufacturer label (that is, product identifier (compound name), signal word (danger or warning), hazard statement(s), pictogram(s), precautionary statements, and name, address and telephone number of the chemical manufacturer, importer, or other responsible party (or for workplace-made labels, the product identifier and any words, pictures, symbols, or combination thereof that provide general information regarding the hazards of the product).

(3) SDS Management. Procedures to ensure SDSs are maintained at the project site for each hazardous or toxic agent so all employees have access to them. The information must be followed in the use, storage, and disposal of material and selection of hazard control and emergency response measures.

(4) Employee Information and Training. Procedures to ensure employees are trained according to paragraph 6-3.b.

b. Process Safety Management (PSM) Program. A written PSM Program must be developed according to 29 CFR 1910.119 (29 CFR 1910 Subpart H) or 29 CFR 1926.64 when any of the following conditions exist: (6-7.b)

(1) A process involves a chemical at or above the specified threshold quantities listed in Appendix A of 29 CFR 1910.119.

(2) A process involves a Category 1 flammable gas or a flammable liquid with a flashpoint below 100 °F (37.8 °C) onsite in one location, in a quantity of 10,000 lbs. (4,535.9 kg) or more, except for, hydrocarbon fuels used solely for workplace consumption as a fuel, if such fuels are not part of a process containing another highly hazardous chemical covered under 29 CFR 1910.119, or flammable liquids with a flashpoint below 100 °F (37.8 °C) stored in atmospheric tanks or transferred which are kept below their normal boiling point without benefit of chilling or refrigeration.

c. Lead Compliance Plan. A written Lead Compliance Plan must be developed when employees may be exposed to lead above the action level, as applicable. The

plan must address the following (see 29 CFR 1910.1025 (29 CFR 1910 Subpart Z) and 29 CFR 1926.62): (6-7.c)

(1) A description of each work activity in which lead is emitted, to include equipment and materials used, crew size, job responsibilities, operating procedures, maintenance practices, and work activity locations and lead-containing components keyed to the project drawings.

(2) Description of control measures to be used to achieve exposure compliance, including any engineering and administrative controls and PPE (see paras 1-6 or 2-6, as applicable).

(3) Employee exposure assessment procedures to monitor and document employee lead exposure. Exposure monitoring must include two types:

(a) Initial determination (may be omitted if there is sufficient objective/historical data showing action level compliance according to the requirements).

(b) Continued exposure monitoring required as a result of initial exposure determinations.

(4) Protective clothing, housekeeping procedures to prevent spread of lead contamination both in and beyond the lead hazard control area, and hygiene facilities and practices to prevent employees from inadvertent ingestion of lead.

(5) Medical surveillance procedures to monitor employee exposures and ensure fitness for wearing respiratory protection (see chapter 5).

(6) Employee training required according to paragraph 6-3.h.

(7) Detailed sketches identifying lead hazard control areas, including decontamination areas and facilities, critical barriers, and physical and air distribution boundaries.

(8) Perimeter or other area air monitoring outside or adjacent to the regulated area.

(9) Security required for each lead hazard control area.

(10) Waste generation, characterization, transportation, and disposal (including recordkeeping).

d. Asbestos Management Plan. A written Asbestos Management Plan must be developed when work is performed that may disturb ACM, as applicable. The plan must address the following (see 29 CFR 1910.1001 (29 CFR 1910 Subpart Z), 29 CFR 1926.1101 (29 CFR 1926 Subpart Z), and 40 CFR 61, Subpart M): (6-7.d)

(1) A description of each activity where asbestos will be disturbed, including OSHA class of work, equipment required, crew size, job responsibilities, operating procedures, maintenance practices, and work activity locations and ACM components keyed to the project drawings.

(2) The method of notification of other employers at the work site.

(3) A description of regulated areas, types of containment, and decontamination unit plan.

(4) Air monitoring plan - personal, environmental, and clearance. Employee exposure assessment procedures must address monitoring and documenting employee exposures.

(a) An initial determination (may be omitted if there is sufficient objective/historical data showing compliance with the requirements).

(b) Continued exposure monitoring may be required as a result of initial exposure determinations.

(c) Environmental monitoring must demonstrate the absence of asbestos fiber migration outside the regulated area.

(d) Clearance monitoring will be conducted by an independent IH or a QP per contract specifications.

(5) Description of control measures to be used to achieve exposure compliance, including any engineering and administrative controls and PPE (see paras 1-6 or 2-6, as applicable).

(6) Housekeeping procedures to prevent spread of asbestos contamination both in and beyond the regulated area.

(7) Hygiene facilities and practices.

(8) Employee training required according to paragraph 6-3.h.

(9) Medical surveillance procedures to monitor employee exposures and ensure fitness for wearing respiratory protection (see chapter 5).

(10) Waste generation, containerization, transportation, and disposal (including recordkeeping).

(11) Security, fire, and medical emergency response procedures.

e. Ionizing Radiation Safety and Radiofrequency (RF) Plans (see EM 385-1-80). (6-7.e)

f. Abrasive Blasting Plan. A written Abrasive Blasting Plan must be developed when abrasive blasting is performed. The plan must address the following: (6-7.f)

(1) Identification of blasting CP and roles and responsibilities.

(2) Identification of blasting equipment make(s) and model(s).

(3) A description of each work activity in which abrasive blasting is required and written SOPs to be implemented for abrasive blasting operations, including pressurized pot procedures (filling, pressurizing, depressurizing, maintenance and inspection).

(4) Selection of abrasive blasting media and description of surface being blasted.

(5) Evaluation to determine composition and toxicity of the abrasive and the dust or fume generated by the blasted material, including surface coatings.

(6) Identify engineering controls, administrative controls to include signage, and PPE to be utilized to minimize exposure during operation to prevent spread of dust, contaminants, and hazardous material in the working area and surrounding area (see paras 1-6 or 2-6, as applicable).

(7) Medical surveillance procedures to monitor employee exposures and ensure fitness for wearing respiratory protection (see chapter 5).

(8) Waste generation, characterization, transportation, and disposal.

(9) Any additional hazards generated because of abrasive blasting work.

(10) Emergency response procedures.

(11) Minimum training and certification requirements (see para 6-3.h).

(12) Methods to inspect blasting equipment according to manufacturer's recommendations.

g. Thermal Stress Management Plan. A written Thermal Stress Management Plan must be developed when employees may be exposed to thermal stressors. The plan must include the following: (6-7.g)

(1) Signs and symptoms of thermal stress illnesses and injuries and first aid procedures for each.

(2) Procedures and control measures for preventing thermal stress illnesses and injuries.

(3) Training on thermal stress according to paragraph 6-3.c.

(4) Methods used to monitor exposures to thermal stressors, including appropriate standards to be utilized and the responsible person to monitor thermal stressors.

h. Mold Remediation Plan. A written Mold Remediation Plan is required when mold remediation activities are performed according to Army TG 277. The plan must include the following: (6-7.h)

(1) Documentation of employee training on proper clean up methods, personal protection, and potential health hazards.

(2) Description of source, location, and extent of mold.

(3) Description of mold growth conditions.

(4) A description of the engineering controls, work practices, and PPE, to include respiratory protection used to limit employee exposure to mold during abatement activities (see paras 1-6 or 2-6, as applicable).

(5) A description of housekeeping measures to limit employee exposure and prevent mold migration.

(6) A description of the procedures used to restrict access to work areas, when necessary, to minimize the number of employees exposed.

(7) Medical surveillance procedures to ensure fitness for wearing respiratory protection (see chapter 5).

(8) Post-remediation air sampling procedures.

i. Silica Compliance Plan. A written Silica Compliance Plan is required when employees may be exposed to respirable crystalline silica, as applicable. The plan must include the following (see 29 CFR 1910.1053 (29 CFR 1910 Subpart Z) and 29 CFR 1926.1153 (29 CFR 1926 Subpart Z)): (6-7.i)

(1) A description of the task(s) in the workplace that involve exposure to respirable crystalline silica.

(2) A description of the engineering controls, work practices, and respiratory protection used to limit employee exposure to respirable crystalline silica for each task.

2. (a) Identify specific exposure control methods per 29 CFR 1926.1153, tables 1 or 2.

(b) Identify alternative exposure control methods for tasks not listed in table 1, or where the employer does not fully and properly implement engineering controls, work practices and respiratory protection described in table 1.

(3) Employee exposure assessment procedures to document employee silica exposure.

(4) A description of the housekeeping measures used to limit employee exposure to respirable crystalline silica.

(5) A description of the procedures used to restrict access to work areas, when necessary, to minimize the number of employees exposed to respirable crystalline silica and their level of exposure, including exposures generated by other employers or sole proprietors.

(6) Medical surveillance procedures to monitor employee exposures and ensure fitness for wearing respiratory protection (see chapter 5).

j. Fatigue Management Plan (FMP). A written FMP is required whenever work hours exceed 10-hours a day for more than four consecutive days, exceed 50-hours in a 7-day work week, exceed 12-hours a day for more than three consecutive days, and/or exceed 58-hours a week for sedentary (to include office) work. The FMP must address the following components and conditions for operator work hour limitations: (6-7.j)

(1) Equipment Operators. Operators of equipment, such as hoisting equipment and draglines, mobile construction equipment, electrical power systems, hydropower plants, industrial manufacturing systems, hydraulically operated equipment, powered vessels, and boats, must not be permitted to exceed 12-hours of duty time in any 24-hour period, including time worked at another occupation. A minimum of eight consecutive hours of rest between shifts in a 24-hour period is required.

(2) Motor Vehicle Operators. Operators of motor vehicles, while on duty, must not operate vehicles for a continuous period of more than 10-hours in any 24-hour period. In addition, no employee, while on duty, may operate a motor vehicle after being in a duty status for more than 12-hours during any 24-hour period. A minimum of eight consecutive hours must be provided for rest in each 24-hour period.

(3) Floating Plant. All floating plant personnel must be scheduled to receive a minimum of 8-hours rest in any 24-hour period, except:

(a) When quarters are provided immediately adjacent to, or aboard the work site, these hours of rest may be divided into no more than two periods, one of which must be at least six continuous hours in length.

(b) Rest periods may be interrupted in case of emergency, drill, or other overriding operational necessity.

(4) Identify affected workers.

(5) Employee training required according to paragraph 6-3.d.

(6) Control measures established at the work site to minimize fatigue including a discussion of driving to and from work and any possible mitigation of driving as a factor of fatigue. Controls for fatigue may include work scheduling (limit number of consecutive night shifts), rotating jobs to prevent repetitive work, breaks at critical times in the work cycle, control of environmental factors (heat, cold, use of PPE), buddy check-in for individuals working alone, and alternate transportation for long commutes. (See paras 1-6 or 2-6, as applicable)

(7) Management responsibility to implement plan requirements.

6-8. General Requirements.

a. Hazard Evaluation and Control. Jobsite operations, materials, and equipment involving potential exposure to hazardous or toxic agents or environments must be evaluated by an IH, or equivalent CP in industrial hygiene operations, to identify workplace hazards and plans required for implementation based on potential exposure (see para 6-7). (6-8.a)

(1) The hazard evaluation must document the workplace and activity evaluated, the nature of the evaluation (air, biological or radiological samples, etc.), any controls and training used, that it serves as certification of hazard evaluation, the name, position, and credentials of the person certifying the evaluation has been performed, and the date of the evaluation. This evaluation must be documented in a written report and available for review by the local SOHO/USACE supervisor/KO or COR.

(2) For USACE operations, frequency of evaluations will be conducted as required by initial survey determination based on DOEHRS-IH shop priorities.

(3) Mitigate hazards according to paragraphs 1-6 or 2-6, as applicable.

(4) In addition, regular housekeeping (work and break area surface cleaning) and personal decontamination procedures must be instituted in areas where operations generate toxic dust and fume hazards. The frequency of surface cleaning and of decontamination procedures is dependent on the nature of the hazard and frequency

and risk from the exposure. Include housekeeping procedures in the applicable plan. (See para 6-7 and chapter 35)

b. Exposure Standards. Occupational exposure, through inhalation, ingestion, skin absorption, or physical contact, to any hazardous or toxic agent more than the OEL is prohibited. (6-8.b)

(1) Comply with all applicable standards and regulations to reduce contaminant concentration levels to as low as reasonably achievable.

(2) For activities where occupational exposure to a chemical or biological warfare agent is possible, comply with current DA SOH requirements for chemical and biological agents such as AR 385-10 chapter 14 Biological Agents, AR 385-10 chapter 21 Chemical Agent Safety Management, and AR 50-6 Chemical Surety.

c. Labs. For laboratory use of chemicals follow 29 CFR 1910.1450 (29 CFR 1910 Subpart Z). (6-8.c)

d. Testing and Monitoring. (6-8.d)

(1) Approved and calibrated testing devices must be provided to measure hazardous or toxic agents and environments. Devices must be labeled with calibration information (that is, name of individual performing the calibration and date of the most current calibration). Calibration results must be maintained in a calibration log. For USACE operations, IH equipment calibration results must be maintained in the DOEHRS-IH.

(2) Individuals performing testing and monitoring must be trained according to paragraph 6-3.

(3) Testing and monitoring devices must be used, inspected, and maintained according to the manufacturer's instructions. Maintain a copy of the manufacturer's instructions with each device.

(4) Use appropriate NIOSH, OSHA, EPA, or DA sampling and analytical methods, or other independently verified sampling and analytical methods.

(5) Laboratories used for analysis must be accredited by nationally recognized bodies, such as the AIHA, for the type of analysis performed.

(6) Determination of the concentration of and hazards from hazardous or toxic agents and environments must be made by a qualified IH or other CP.

(7) Perform testing and monitoring during initial startup and as frequently as necessary to ensure the safety and health of the workers or other potentially exposed individuals.

(8) Records of testing/monitoring must be maintained onsite and must be available to the local SOHO/USACE supervisor/KO or COR, upon request. For USACE operations, records of testing/monitoring are to be maintained in DOEHRs-IH.

e. Hazardous and Toxic Agents Handling. (6-8.e)

(1) When engineering and work practice controls or substitution are either infeasible or insufficient, appropriate PPE and chemical hygiene facilities must be provided and used for the handling of hazardous or toxic agents.

(a) Refer to the SDS to determine PPE requirements. An IH, Safety, or other CP must determine the scope and type of PPE required.

(a-1) Special attention must be given to selecting proper chemical protection when working with materials designated with a “skin” notation by OEL. Such materials may produce systemic toxic effects through absorption through unbroken skin. (See chapter 5)

(a-2) Before commencing use of epoxy resins, concrete, or other dermatitis-producing substances, employees must be made aware of the manufacturer’s skin protection recommendations. Barrier cream ointment or other skin protection measures recommended by the manufacturer or the SDS for the specific exposure must be available for use.

(b) When the eyes or body of any person may be exposed to hazardous or toxic agents and suitable facilities for drenching or flushing of the eyes and body are required, they must comply with ANSI Z358.1. Such facilities must be provided in the work area for immediate emergency use, no more than 10 seconds from the hazardous or toxic agent.

(b-1) Emergency eyewash equipment must be provided where there is the potential for an employee’s eyes to be exposed to corrosives, strong irritants, or toxic chemicals.

(b-2) The emergency eyewash equipment must irrigate and flush both eyes simultaneously while the operator holds the eyes open.

(b-3) The emergency eyewash equipment must deliver at least 0.4 gal (1.5 L) of water per minute for 15 minutes or more, providing a minimum of 6 gal (22.7 L) of water.

(b-4) Water used in emergency eyewashes and showers must meet potable water standards. When these items are exposed to the elements, steps will be taken to ensure the water does not freeze or become stagnate.

(b-5) Personal eyewash equipment may be used to supplement emergency washing facilities, they cannot be used as a substitute (see para 6-5.b).

(b-6) All plumbed emergency facilities and hand-held drench hoses must be connected to an approved potable water supply and activated weekly.

(b-7) All facilities must be inspected according to paragraph 6-5.b to ensure they function correctly and the quality and quantity of water is satisfactory for emergency washing purposes.

(c) When personal protective clothing is required, an area must be established for the removal of the personal protective clothing which limits the spread of any chemical waste, dust, or fume, and workers must be trained in the removal of personal protective clothing and equipment to prevent further spread or contamination (see chapter 35).

(2) Store hazardous or toxic agents so that they are only accessible to authorized personnel and NFPA 400 according to the manufacturer's recommendations (for example, SDS), 29 CFR 1910 Subpart H and requirements.

(3) Hazardous material must be segregated into appropriate storage designated for ignitability (flammable substances), corrosivity (acids and bases), reactivity (avoid water, temperature, pressure), and toxicity according to 29 CFR 1910 Subpart Z, 29 CFR 1915 Subpart Z, and 29 CFR 1926 Subpart Z.

(4) All hazardous chemicals, materials, substances, and wastes being stored prior to transportation must be under the supervision of a qualified person (see para 6-4.b).

(5) Transportation, use, and storage of hazardous or toxic agents must be planned and controlled to prevent contamination of people, animals, food, water, equipment, materials, and environment.

(6) Dispose of surplus or excess hazardous or toxic agents in a manner that will not contaminate or pollute any water supply, ground water, or streams, and that complies with applicable federal, state, and local requirements and guidelines.

(7) Do not use containers that have held hazardous or toxic agents to hold other materials unless they have been managed or cleaned under hazardous waste and DOT regulatory requirements.

(8) Every hazardous or toxic agent being transported for disposal must be transported with a copy of the substance's SDS.

(9) Persons who prepare shipments of hazardous chemicals, materials, substances and/or wastes that are defined as hazardous material under DOT regulations are required to be trained according to paragraph 6-3.f.

f. Asbestos and Lead Hazard Control. (6-8.f)

(1) Asbestos Hazard Control.

- (a) Known friable ACMs must not be used or brought onto any USACE projects.
- (b) Evaluate all construction or maintenance projects for the potential to contact ACM.
- (c) Label all ACM an asbestos hazard that must not be disturbed without proper protection. If presumed asbestos containing materials or ACM is inaccessible to label, create and post a site map that identifies the location of the asbestos hazards.
- (d) If evaluation shows the potential for activities to disturb ACM, an Asbestos Management Plan must be developed and employees trained according to paragraphs 6-3.h and 6-7.d. If regulations in local jurisdictions exceed federal requirements, the most stringent will apply.

(2) Lead Hazard Control.

- (a) Lead-based paints will only be used with prior written approval of the local SOHO/USACE supervisor or accepted by the KO or COR and must never be used inside a residence, childcare facility, or medical treatment facility.
- (b) Evaluate all construction or maintenance projects for the potential to create an occupational lead hazard exposure.
- (c) Label all lead sources that may generate an occupational exposure. If lead hazards are inaccessible or infeasible to label, create and post a site map that identifies the location of the lead hazards.
- (d) If evaluation shows the potential for activities to generate an occupational exposure to lead, a written Lead Compliance Plan must be developed and employees trained according to paragraphs 6-3.h and 6-7.c. If regulations in local jurisdictions exceed federal requirements, the most stringent will apply.

g. Hot Substances. (6-8.g)

- (1) Protection from Hot Substances. Hazards from hot substances include increased inhalation and skin hazards and burns from the heat. When working with hot substances the following must be considered:
 - (a) PPE (for example, respirators, gloves) must be evaluated for efficiency in hot atmospheres and protectiveness from heat as well as the chemical hazard.
 - (b) Heat stress precautions and measurements (see para 5-8.n).
 - (c) Location where hot substances are heated must be located away from any ventilation intake air vents. If hot substances are being applied to a roof, the ventilation intake air vents must be temporarily relocated to prevent the uptake of the hazardous air

contaminants into the building, or the work must be completed at a time when the building is not occupied. Ventilation requirements are further addressed in paragraph 6-8.j.

(2) Transporting and Handling Hot Substances.

(a) Provide runways or passageways clear of obstructions for all persons carrying hot substances.

(b) Do not carry hot substances up or down ladders.

(c) When hoists are used to raise or lower hot substances, ensure the hoisting mechanism is adequate for the loads imposed and is securely braced and anchored.

(d) Provide protection to all persons handling hot substances against contact with, or exposure to radiant heat, glare, fumes, and vapors of the substances. At a minimum, roofers handling roofing materials must be fully clothed including long sleeved shirts, shoes secured at least 6 inches (15.2 cm) in height and gloves up to the wrist. (See chapter 5)

(e) Containers for handling and transporting hot substances must be of substantial construction (minimum 24-gauge sheet steel), free from any soldered joints or attachments, and must not be filled higher than 4 inches (10.2 cm) from the top.

(f) Piping used to transport hot substances must have an entry and exit shut off valve and must be made of flexible metallic hoses fitted with insulated handles. In cold climates, piping must be insulated to prevent material from solidifying on the inside of the pipe.

h. Harmful Plants, Animals, and Insects. (6-8.h)

(1) Provide protection from disease-carrying or flea-harboring insects or animals according to the following, as applicable:

(a) Ensure PPE such as netted hoods, leather work gloves, and high-top work boots are worn in conjunction with trousers and long-sleeved shirts.

(b) Clothing treated at the factory with DEET or Permethrin is recommended in areas of high insect population.

(c) Drain or spray breeding areas in heavily trafficked and inhabited areas.

(d) Destroy or flag (mark as hazard) nests.

(e) Use smudge pots and aerosols to protect workers and small areas.

(f) Eliminate actions or conditions that propagate insects or vermin.

(g) When necessary, exterminate areas or facilities (see chapter 35).

(h) Ensure employees are trained to perform the necessary first aid response according to chapter 3. Employees allergic to plants, animals, or insects are encouraged to self-identify to their supervisor and carry the necessary response materials (for example, EpiPen).

(i) Provide inoculation against diseases known to be a local hazard.

(j) Provide training to necessary employees according to paragraph 6-3.g.

(2) In areas where there is exposure to poisonous or venomous snakes or lizards, ensure PPE such as snake chaps or knee-high snake boots are worn in conjunction with trousers and long-sleeved shirts.

(3) In areas where employees are exposed to poisonous plants, provide the following protective measures, as applicable:

(a) Remove or destroy plants, where practicable. When burning poisonous plants, implement controls to prevent contact with or inhalation of toxic elements contained in the smoke.

(b) Provide appropriate protective clothing such as gloves.

(c) Provide protective ointments.

(d) Provide soap and water for washing exposed parts.

(e) Provide training to necessary employees according to paragraph 6-3.g.

i. Ionizing Radiation and Non-Ionizing Radiation, Magnetic, and Electric Fields (see EM 385-1-80). (6-8.i)

j. Ventilation and Exhaust Systems. (6-8.j)

(1) Portable and Temporary Ventilation Systems.

(a) All portable or temporary ventilation systems must remove dusts, fumes, mists, vapors, and gases away from the worker and the work environment or provide air to prevent an oxygen deficient atmosphere.

(b) Portable or temporary ventilation systems must be used as designed by the manufacturer. All hoses must be only as long as the maximum allowed by the manufacturer to provide the required air flow at the supply or exhaust point. If adding or

changing hoses, use only hoses and/or connectors that are comparable and compatible with the hoses and connectors provided by the manufacturer.

(c) Make-up air for air supply ventilation systems must draw air free of contaminants and away from any potential contaminant source.

(d) Any portable or temporary ventilation system and the locations where the systems are to be used must be approved by the local SOHO/USACE supervisor or accepted by the KO or COR before use. Provide manufacturer information or design criteria with the request for acceptance.

(e) Use high efficiency, filtered, recirculated ventilation units when:

(e-1) The filtration system lowers the levels of any airborne contaminants from the operation to less than half of the OEL. This must be documented by an IH or CP through sampling for the contaminants.

(e-2) The unit and filtration are regularly maintained and the maintenance procedure and schedule are written and documented when maintenance is completed.

(2) Ventilation systems must be operated and maintained to ensure the maintenance of volume and velocity of exhaust air is sufficient to gather contaminants and safely transport them to suitable points for removal.

(3) Duration of Operation.

(a) Ventilation systems must be operated continuously during operations when persons are exposed to airborne contaminants at or above the OEL or explosive gases at or above acceptable safe limits as defined in paragraph 6-8.b or as otherwise specified by this manual, referenced standards, or regulations.

(b) Ventilation systems must remain in operation for a time after the work process or equipment has ceased to ensure the removal of any contaminants in suspension or vaporizing into the air.

(4) Local exhaust ventilation systems must be periodically evaluated to ensure proper contaminant capture, movement through the system, and filtration or exhaust to the outside.

(5) Dusts and refuse materials removed by exhaust systems or other methods must be disposed of in a manner that will not create a hazard to employees or the public and according to this manual, applicable federal, state, and local requirements.

(6) Evaluate ventilation systems used to remove hazardous dusts, fumes, gases, or substances according to paragraph 6-5.c. The cleaning of the ventilation system must be part of the written Housekeeping Plan. (See chapter 35)

k. Abrasive Blasting. Silica sand must not be used as an abrasive blasting media. Alternative abrasive blasting materials are available and listed in table 6-1. (6-8.k)

(1) When abrasive blasting is performed, an Abrasive Blasting Plan must be developed and employees trained according to paragraphs 6-7.f and 6-3.h.

(2) Blast Cleaning Enclosures and Rooms.

(a) Exhaust systems must be part of a regular cleaning and maintenance program (see para 6-5.d).

(b) All air inlets and access openings must be baffled to prevent the escape of abrasive agents and contaminants.

(c) Provide air inlet flow according to the operation specific minimums of ANSI Z9.4.

(d) Negative pressure must be maintained inside during blasting.

(e) Transport velocities of the system must be at a minimum 3,500 feet per minute (fpm) (17.8 m/s), but 4,000 to 5,000 fpm (20.3 to 25.4 m/s) is recommended by ANSI Z9.4.

(f) The rate of exhaust must be sufficient to provide prompt clearance of the dust-laden air within the enclosure after cessation of the blasting. Appendix A of ANSI Z9.4 outlines minimal airflow velocities for various devices.

(g) If abrasive blasting is automated, the blast must be turned off before the enclosure is opened. The exhaust system must run for a sufficient period to remove the dusty air within the enclosure to minimize the escape of dust into the workroom and prevent any health hazard.

(h) Perform routine cleanup using wet methods or HEPA filtered vacuuming to minimize the accumulation of dusts. Broom sweeping or compressed air is prohibited. If the blasting agent is removed manually, appropriate PPE, including respiratory protection, must be worn and not removed until outside the blasting room.

(i) For blasting cabinets, inward air velocity at the hand openings must be 500 fpm (2.5 m/s) measured at the free openings without the curtains due to proximity of operator. Gloves inserted must be inspected prior to every use according to paragraph 6-5.d. The cabinet must have a minimum of 20 air changes per minute.

(3) Blasting Without Enclosures.

(a) If abrasive blasting must be performed inside a building without enclosures, respiratory protection must be provided for all employees in the area according to

chapter 5. Portable engineering control devices must also be used at the location to collect the entire used abrasive agent as it is applied.

(b) When airborne abrasive blasting dust becomes sufficiently heavy in an area to cause a temporary safety hazard by reduced visibility or discomfort to the unprotected employees not engaged in abrasive blasting, such operations in the affected area must be discontinued until the airborne dust is removed by exhaust ventilation and the settled dust has been removed from the horizontal surfaces in the area.

(c) Abrasive materials must not be allowed to accumulate on aisles and walkways to create a slipping hazard.

(d) If wet abrasive blasting is employed to reduce dust exposures, the aerosols produced and the dried residues that become airborne might be potential hazards and must be considered.

(4) Confined Spaces. Abrasive blasting work conducted in a confined space must be performed according to chapter 34. Use exhaust ventilation systems in containment structures to capture dust.

(5) Blasting Outdoors.

(a) Work completed outside has been shown to create exposures to health hazards for the worker and other trades in the area. Air and noise samples must be taken to document the level of exposure to the worker and the workers in the area, unless similar operations documented no exposure. Blasters must be protected with proper PPE (see chapter 5) and proper ventilation (see 29 CFR 1910.94).

(b) Engineering controls and work practices, such as wet blasting methods, must be used to prevent the dust from spreading to other work areas. Check with local and state requirements which may add restrictions to outdoor abrasive blasting. If the surface to be blasted is painted or contains high levels of silica and/or heavy metals, such as lead, chromium, or cadmium, an enclosure may be required to prevent disbursement of the hazard.

(6) Hearing protection and respiratory protection must be available to all employees in areas where the associated hazards exist (see chapter 5).

I. Personal Protective Equipment (PPE). (6-8.I)

(1) Select and use PPE according to chapter 5. If reusable coveralls are used, they must be vacuumed before all breaks and removed at the end of the shift. Clothes must not be taken home to be cleaned by the worker or family, they must be laundered by the employer. (See chapter 35)

(2) Air-supplied helmets, blast helmets/hoods, respirators, earmuffs, safety boots or toe guards, durable coveralls closeable at wrists, ankles, and other openings, and safety glasses should be an individual issue item, identified with and used by only one employee. Such equipment may be reissued to another employee only after complete cleaning, repair, and decontamination.

(3) Clean and store air-supplied respiratory equipment after each shift of use. Storage must be in a clean enclosure such as locker, footlocker, plastic container, or zip-lock type bag. Employees must be trained to maintain issued equipment in clean and good working condition.

(4) Replace visibly damaged safety glasses (plano or prescription).

(5) Replace faceplates in air-supplied helmets and blast helmets/hoods when a side-on light source produces obscuring visible reflections and glare from the etched spots and pit holes in the faceplate. Mylar coating, or similar transparent plastic material, is recommended to protect the glass or plastic faceplate.

(6) Do not alter the length of air hose(s) from the manufacturer's specifications.

(7) Daily checks must be performed by the wearer of PPE to maintain it in good working condition. Rips, tears, and openings of PPE that expose skin to abrasive agents must be mended or replaced. Functional tests for leaks, proper respiration, and good connections must be performed on the complete air-supply system.

(8) Air supply, portable.

(a) The breathable air supplied to the blast helmet or hood must be Grade D quality air per 29 CFR 1910.134(i) for breathing air quality and use. The compressed air used for blasting must be isolated and separated from the compressed air line used for breathing air. The compressed air line for breathing air must be used per manufacturer's recommendations and be adequately labeled to clearly state quality air if being provided by the same compressor as the blasting air. Breathable air-supply system should be equipped, if possible, with audible alarm at the helmet or hood to warn the user of low air pressure.

(b) Hearing protection. Suitable hearing protection, capable of attenuating employee noise exposure according to chapter 5, must be worn.

(c) Heat stress. Cooling of breathable air, supplied to the blast helmets/hoods, should be considered depending on season and employee exposure to heat sources.

m. Thermal Stressors Management. When employees may be exposed to thermal stressors, a Thermal Stress Management Plan must be developed and employees trained according to paragraphs 6-7.g and 6-3.c. Take into consideration the influence of environmental conditions, workload, and personal factors. (6-8.m)

(1) Implement a buddy system. Workers should not only monitor themselves, but also be alert to changes and the symptoms of their co-workers.

(2) Provide readily available potable drinking water to all employees (see chapter 35).

(3) Allow workers to adequately acclimatize to work conditions.

(4) Monitor weather conditions. When possible, schedule work activities to minimize thermal stress exposure.

(5) Comply with thermal stressor management recommendations as promulgated by Centers for Disease Control (CDC)/NIOSH Heat Stress and Cold Stress (see <https://www.cdc.gov/niosh/topics/heatstress/default.html> or <https://www.osha.gov/winter-weather/cold-stress>), OSHA Heat Stress and Cold Stress (see <https://www.osha.gov/heat-exposure> or <https://www.osha.gov/winter-weather/cold-stress>), and the Defense Centers for Public Health - Aberdeen Heat Illness Prevention and Cold Injury Prevention (see <https://phc.amedd.army.mil/topics/discond/hipss/Pages/default.aspx> or <https://phc.amedd.army.mil/TOPICS/DISCOND/CIP/Pages/default.aspx>).

n. Industrial Ergonomics. (6-8.n)

(1) Work activities that require employees to conduct lifting, handling, or carrying; rapid and frequent application of high grasping forces; repetitive hand/arm manipulations; tasks that include continuous, intermittent, impulsive, or impact hand-arm vibration or whole-body vibration; and other physical activities that stress the body's capabilities must be evaluated by a CP to ensure the activities are designed to match the capabilities of the employees.

(2) When work activities include items listed in paragraph 6-8.n(1), the employer must identify and document hazards and controls via the associated AHA. The AHA must incorporate processes that recognize cumulative trauma hazards, isolate causative factors, provide controls and train as appropriate.

(3) Specific control measures to minimize vibration may include use of anti-vibration tools and/or gloves; implementation of work practices that keep the employee's hands and body warm/minimize vibration coupling between employee and the vibration tool; application of specialized medical surveillance to identify personnel susceptible to vibration; and adherence to TLV guidelines as specified by ACGIH in "Threshold Limit Values and Biological Exposure Indices". For USACE only, the evaluation must be according to ER 385-1-96, ANSI S2.70, ANSI S2.73, ISO 5349, and ISO 8662.

o. Indoor Air Quality (IAQ) Management. (6-8.o)

(1) Investigations. IAQ must be brought to the attention of the facility manager/owner or other designated representative who is responsible for resolving the

IAQ complaint in a timely manner. For leased facilities, procedures for resolving IAQ issues should ultimately be investigated and resolved by the lessor. An IH or CP should initiate an IAQ investigation using appropriate guidelines published by ACGIH; AIHA; ANSI; American Society of Heating, Refrigeration, and Air Conditioning Engineers; EPA; OSHA; NIOSH; or other federal, DoD, state, local, and host nation requirements.

(2) Environmental tobacco smoke (ETS) and vaping products. Employees must be protected from involuntary exposure to ETS and vaping in working and public living environments. Smoking, to include the use of smokeless cigarettes or cigars, is prohibited inside all DoD vehicles, aircraft, vessels, and work buildings. Provide designated smoking areas (that is, outdoors) that are at least 50 feet (15.2 m) from building entrances and in areas that are not commonly used or accessed by nonsmokers.

(3) Mold Assessment. Because mold can contribute to health concerns ranging from minor irritation to serious debilitation if found in high quantities or improper locations, a mold assessment must be performed when need is indicated.

(a) Assessments/remediation must be overseen by a competent mold inspector according to paragraph 6-3.i.

(a-1) Mold remediation should not be performed by the same entity that performed the mold assessment.

(a-2) Employees in the immediate area of the mold contamination must be informed of the remediation, results of any testing, and symptoms of the hazard. The employees must not be in the area during the remediation.

(a-3) Post-remediation air sampling must be done in the immediate area and in any areas in the mold spore or vegetative air-pathway and compared to outside air samples. Mold in areas above drop ceilings with combined air plenums must have air samples taken within the plenum as well as in air-serviced areas. Air samples should be taken in the immediate area of remediation and analyzed by a laboratory in the AIHA Environmental Microbiology Laboratory Accreditation Program.

(b) A visual assessment of potential mold hazards must be performed, based on criteria in the TG 278, the EPA IAQ Management Checklists, and guidance from AIHA. Bulk and/or air samples are generally not necessary to evaluate mold hazardous environments.

(c) A mold assessment must be written and must contain the following:

(c-1) Description of the area assessed including size (footprint), ventilation, and occupancy.

(c-2) Name and qualifications of the individual completing the assessment.

(c-3) Results of samples taken, including location of the sample result, date and time of the sample, temperature, and humidity at the time of the sample, and laboratory procedure used to analyze the sample.

(c-4) Drawing of the area showing location of samples, location of visible mold or mildew and the type of substrate it is growing on, ventilation sources in the room, and other information thought to be important.

(c-5) Potential sources of the moisture which has caused the mold growth.

(c-6) Recommendations for controlling the problem and remediating the mold.

(d) Causes of mold (for example, water leakages, seepages, drainage, HVAC/insulation damage) must be addressed before completing mold remediation.

(e) If the assessment indicates remediation is required, a Mold Remediation Plan must be developed according to paragraph 6-7.h.

p. Control of Chromium (VI) Exposure. (6-8.p)

(1) General. All activities which could generate chromium (VI) fumes, mists, or dusts must be evaluated by an IH to determine potential personnel exposure over the OEL. Typical operations where chromium exposures are high include cutting or breaking up of cement surfaces made from Portland cement with a high chromium content, painting or paint removal operations, welding using rods or wire with a chromium coating, heating or welding on stainless steel, and handling or applying anti-corrosive substances or coatings.

(a) The evaluation must include a risk assessment of the type and frequency of exposure and breathing zone air sampling in the work and surrounding area according to applicable OSHA/EPA standards.

(b) The evaluation must be added as an appendix to the APP or the Project SOH Plan. Individual sample results must be provided to the employee and add to their official occupational health record and a summary of the sample results should be posted in the work area.

(2) To prevent exposure to chromium (VI), the use of paints with chromium pigments, Portland cement with greater than 0.002% chromium, or chromium/arsenic treated lumber must be avoided when possible. Should chromium (VI) containing products be required, a justification and similar non-chromium (VI) product evaluation must be conducted and submitted for review by the local SOHO/USACE supervisor/KO or COR.

(3) If chromium containing compounds are used and the objective determination is inconclusive, before air sampling confirms the level of exposure, the employer must

comply with the requirements of 29 CFR 1910.1026 (29 CFR 1910 Subpart Z), 29 CFR 1915.1026 (29 CFR 1915 Subpart Z), or 29 CFR 1926.1126 (29 CFR 1926 Subpart Z), whichever is applicable. At a minimum, employers must provide appropriate PPE, respirators, decontamination facilities, and a lunchroom/area clean from chromium (IV) dust and/or fume.

(4) If air sampling confirms chromium (VI) exposure over the OEL, and there is no adequate substitute or work practice change (for example, use of argon instead of carbon dioxide (CO₂) when arc welding), then the employer must provide appropriate engineering controls (for example, local HEPA filtered ventilation systems, medical surveillance, housekeeping, and air sampling as required by the applicable chromium (VI) standard). If adequate engineering controls are not feasible or appropriate due to the length of the task, then PPE must be provided.

(5) In areas where chromium (VI) is generated or used, there must be a housekeeping plan according to applicable OSHA/EPA standards and decontamination program instituted.

(a) Maintain surfaces as free as practicable of accumulations of chromium (VI), as required by the applicable OSHA standard.

(a-1) The employer will ensure that surfaces contaminated with chromium (VI) are cleaned by HEPA-filter vacuuming or other methods that minimize the likelihood of exposure to chromium (VI).

(a-2) The employer will ensure cleaning equipment is handled in a manner which minimizes the reentry of Chromium (VI) into the workplace.

(b) At a minimum all exhaust and ventilation systems must be cleaned and filters changed according to manufacturer's recommendations.

(c) Workers will not enter eating and drinking areas with protective work clothing or equipment unless surface chromium (VI) has been removed from the clothing and equipment by methods that do not disperse chromium (VI) into the air.

q. Crystalline Silica. (6-8.q)

(1) The employer must ensure no employee is exposed to an airborne concentration of respirable crystalline silica more than 25 micrograms (ACGIH) per cubic meter of air, as calculated as an 8-hour TWA.

(2) All exposures to respirable crystalline silica, except where employee exposure will remain below 25 micrograms per cubic meter of air as an 8-hour TWA, will be regulated by applicable OSHA/EPA standards.

(3) The employer must assess the exposure of each employee who is or may reasonably be expected to be exposed to respirable crystalline silica at or above the action level (12.5 micrograms per cubic meter of air as an 8-hour TWA).

(a) If initial monitoring indicates employee exposures are below the action level, the employer may discontinue monitoring for those employees whose exposures are represented by such monitoring.

(b) Where the most recent exposure monitoring indicates employee exposures are at or above the action level, but at or below the OEL, the employer must repeat such monitoring within six months of the most recent monitoring.

(c) Where the most recent exposure monitoring indicates employee exposures are above the OEL, the employer must repeat such monitoring within three months of the most recent monitoring.

(d) Where the most recent (non-initial) exposure monitoring indicates employee exposures are below the action level, the employer must repeat such monitoring within six months of the most recent monitoring until two consecutive measurements, taken seven or more days apart, are below the action level, at which time the employer may discontinue monitoring for those employees whose exposures are represented by such monitoring.

(e) The employer must reassess exposures whenever a change in the production, process, control equipment, personnel, or work practices may reasonably be expected to result in new or additional exposures at or above the action level, or when the employer has any reason to believe new or additional exposures at or above the action level have occurred.

(4) Control mechanisms must be implemented to reduce employee exposures if exposure data indicates action levels are exceeded.

(5) If the evaluation shows the potential for activities to generate an occupational exposure to silica exceeding the action level, a written Silica Compliance Plan must be developed according to paragraph 6-7.i and employees trained according to paragraph 6-3.h. If regulations in local jurisdictions exceed federal requirements, the most stringent will apply.

6-9. Figures and Tables.

**Table 6-1
Abrasive Blasting Media, Silica Substitutes**

Applications	Media	Advantages
Cleaning Hard Metals (Titanium); Removing Metal Etch Glass; Carve Granite	Aluminum Oxide	Recyclable
General Paint Removal Stripping Aircraft Skins Cleaning Surfaces in Food Processing Plants Removing Paint from Glass	Baking Soda (Sodium Bicarbonate)	Less Material Used/Less Cleanup Low Nozzle Pressures (35-90 pounds per square inch (PSI)) Non-Sparking Water Soluble
General Paint, Rust, & Scale Removal from Steel Paint Removal from Wood Exposure of Aggregates	Coal Slag	Less than 1% Free Silica Inert, Fast Cutting Creates Anchor Profile
General Paint, Rust & Scale Removal from Steel Paint Removal from Wood	Copper Slag	Rapid Cutting
Deburring Paint & Rust Removal from Wood & Metal	Corn Cob Granules	Low Consumption Low Dust Levels Biodegradable
Cleaning Aircraft Parts Cleaning Exotic Metals	Dry Ice (CO ₂)	No Residue Remains Minimal Cleanup
General Paint, Rust & Scale Removal from Steel	Garnet	Lower Nozzle Pressure (60-70 PSI) Low Dust Levels Fast Cleaning Rates Can be Recycled 6-7 Times Low Free Silica
Cleaning & Polishing Deburring	Glass Beads	Uniform Size and Shape Recyclable Provide High Luster Polished Surface
General Paint, Rust & Scale Removal from Steel	Nickel Slag	Rapid Cutting
Cleaning Soft Materials (for example, Aluminum, Plastic, Wood)Cleaning Surfaces in the Petroleum Industry	Nut Shells	High Removal Speed Non-Sparking Low Consumption
Clean Light Mill Scale/Rust from Steel 2.5 MIL Profile & Finer	Olivine	Low Chloride Ion Level Low Conductivity

6-10. Checklists and Forms.

Not Applicable.

Chapter 7 Lighting

7-1. References.

- a. American Bureau of Shipping (ABS), Guide for Crew Habitability on Ships (<https://ww2.eagle.org/en/rules-and-resources/rules-and-guides.html>) (7-1.a)
- b. ANSI/Illuminating Engineering Society (IES), The Lighting Library (<https://store.ies.org/product/ies-lighting-library-collection-subscription/>) (7-1.b)
- c. ANSI Workplace Lighting Standards (<https://webstore.ansi.org/industry/workplace-lighting?source=blog>) (7-1.c)
- d. NFPA 101, Life Safety Code (<https://www.nfpa.org/Codes-and-Standards>) (7-1.d)
- e. United Facilities Criteria (UFC) 3-530-01, Interior and Exterior Lighting Systems and Controls (<https://www.wbdg.org/ffc/dod/unified-facilities-criteria-ufc>) (7-1.e)
- f. 29 CFR 1926.56, Illumination (<https://www.govinfo.gov/content/pkg/CFR-2020-title29-vol8/pdf/CFR-2020-title29-vol8-sec1926-56.pdf>) (7-1.f)

7-2. Definitions.

- a. Foot Candle. The English and American traditional measurement unit of light (illuminance) as perceived by the human eye, and is roughly equal to 10.7 Lux. (7-2.a)
- b. Lux. The International System of Units measurement of light (illuminance) as perceived by the human eye. (7-2.b)

7-3. Personnel Required Training/Qualification.

Not Applicable.

7-4. Roles and Responsibilities.

Not Applicable.

7-5. Inspection Requirements.

Conduct and document a survey of the area to be lighted by generator-powered lighting units to ensure overhead power lines do not pose a hazard.

7-6. Activity Hazard Analysis (AHA) Requirements.

Develop AHAs according to paragraphs 1-6 or 2-6, as applicable. Review the lighting requirements for specific tasks or operations as part of AHA development.

7-7. Minimum Plan Requirements.

Night Operations Lighting Plan. If work is to be performed at night, a Night Operations Lighting Plan must be developed to ensure all activities, areas, and operations are adequately illuminated to perform work safely. The plan must be submitted to the USACE supervisor for approval or to the KO or COR for acceptance and include the following:

- a. A map of the work area to be illuminated. (7-7.a)
- b. Locations of all lighting units used to meet minimum lighting levels. (7-7.b)
- c. Identification of required lighting level by area. (7-7.c)
- d. Identification of onsite personnel responsible for verifying lighting plan is effective and does not present a glare hazard for nearby roadways and other public transportation. (7-7.d)

7-8. General Requirements.

a. Lighting Levels. While work is in progress, facilities, accessways, working areas, roads, etc., must be illuminated to not less than the minimum intensities specified below (see table 7-1 for limited reference and requirements). Areas not specified below must be illuminated according to the minimum intensities specified in the applicable ANSI Workplace Lighting Standards. (7-8.a)

- (1) For construction work sites, see 29 CFR 1926.56.
- (2) Design DoD facilities, according to UFC 3-530-01.
- (3) For marine lighting, see ABS, Guide for Crew Habitability on Ships.
- (4) For illumination of means of egress and emergency lighting, see NFPA 101.
 - (a) Provide emergency lighting for buildings under construction when the progress of construction or environmental conditions limits the ability of natural lighting to provide safe egress (average of 1 foot candle or 10.7 Lux) during a power outage.
 - (b) The illumination must be arranged so that the failure of any single lighting unit, including the burning out of an electric bulb, will not leave any area darkened to the point of impeding the means of egress.
- (5) Take and record illumination readings, with a calibrated light meter, when the minimum lighting requirements of an area is in question.

b. Lighting Fixtures. (7-8.b)

(1) Guard and secure lamps and lighting fixtures to preclude injury to personnel. Light fixtures used for general illumination must be provided with protection to prevent accidental contact or breakage.

(a) Provide lighting fixtures within 7 feet (2.1 m) of a normal working surface with suitable fixtures or lamp holder with a guard.

(b) Open fixtures must have wire guards, lenses, tube guards and locks, or safety sockets that require force in the horizontal axis to remove the lamp, or other means to prevent damage to the bulb.

(2) When buildings are equipped with overhead sprinkler systems, lighting fixtures must be no closer than 18 inches (45.7 cm) to an overhead sprinkler.

c. Temporary lighting. (7-8.c)

(1) Temporary lighting will be installed according to chapter 11.

(2) Generator-powered portable lighting units must be grounded according to the manufacturer's instructions. Conduct overhead power line survey according to paragraph 7-5.

7-9. Figures and Tables.

**Table 7-1
Minimum Lighting Requirements**

Facility	Function	Foot-Candles	Lux
Accessways	General indoor	5	54
Accessways	General outdoor	3	32
Accessways	Exit ways, walkways, ladders, stairs	10	108
Administrative Areas	Offices, drafting and meeting rooms, etc.	50	538
Chemical Laboratories	Chemical laboratories	50	538
Construction Areas	General indoor	5	54
Construction Areas	General outdoor	3	32
Construction Areas	Tunnels and general underground work areas (min 110 lux required at tunnel/shaft heading during drilling, mucking, and scaling)	5	54
Conveyor Routes	Conveyor routes	10	108
Dam Operating Areas (Interior)	Tunnels and underground work areas	5	54

Table 7-1
Minimum Lighting Requirements — Continued

Facility	Function	Foot-Candles	Lux
Dam Operating Areas (Interior)	Control stations	15	<u>161</u>
Docks and Loading Platforms	Docks and loading platforms	3	32
Elevators, Freight, and Passenger	Elevators, freight, and passenger	5	<u>54</u>
Temporary Electrical Panels	Interior	30	<u>325</u>
Temporary Electrical Panels	Exterior	10	<u>108</u>
First-Aid Stations and Infirmaries	First-aid stations and infirmaries	30	<u>323</u>
Maintenance/Operating Areas/Shops	Vehicle maintenance shop	30	323
Maintenance/Operating Areas/Shops	Carpentry shop	10	108
Maintenance/Operating Areas/Shops	Refueling area, outdoors	5	54
Maintenance/Operating Areas/Shops	Shops, fine detail work	50	538
Maintenance/Operating Areas/Shops	Shops, medium detail work	30	323
Maintenance/Operating Areas/Shops	Welding shop	30	<u>323</u>
Maintenance/Operating Areas/Shops	<u>Machine shop</u>	<u>30</u>	<u>323</u>
Maintenance/Operating Areas/Shops	<u>Lofts</u>	<u>10</u>	<u>108</u>
Maintenance/Operating Areas/Shops	<u>Tool room</u>	<u>10</u>	<u>108</u>
Maintenance/Operating Areas/Shops	<u>General construction plant and shops</u>	<u>10</u>	<u>108</u>
Maintenance/Operating Areas/Shops	<u>Batch plants</u>	<u>10</u>	<u>108</u>
Maintenance/Operating Areas/Shops	<u>Screening plants</u>	<u>10</u>	<u>108</u>
Maintenance/Operating Areas/Shops	<u>Rigging lofts</u>	<u>10</u>	<u>108</u>
Mechanical/Electrical Equipment Rooms	Mechanical/electrical equipment rooms	10	108
Outdoor Parking Areas	Outdoor parking areas	3	32

Table 7-1**Minimum Lighting Requirements — Continued**

Facility	Function	Foot-Candles	Lux
Toilets, Wash, and Dressing Rooms	Toilets, wash, and dressing rooms	10	108
Visitor Areas	Visitor areas	20	215
Warehouses and Storage Rooms/Areas	Indoor rack storage	25	269
Warehouses and Storage Rooms/Areas	Outdoor storage	3	32
Work areas – General (not listed above)	Work areas – General (not listed above)	30	323
<u>Vessel – General Areas</u>	<u>Mess Halls, Dining Halls</u>	<u>30</u>	<u>323</u>
<u>Vessel – General Areas</u>	<u>Accessways</u>	<u>3</u>	<u>32</u>
<u>Vessel – General Areas</u>	<u>Exits</u>	<u>3</u>	<u>32</u>
<u>Vessel – General Areas</u>	<u>Gangways</u>	<u>3</u>	<u>32</u>
<u>Vessel – General Areas</u>	<u>Stairs</u>	<u>3</u>	<u>32</u>
<u>Vessel – General Areas</u>	<u>Walkways</u>	<u>3</u>	<u>32</u>
<u>Vessel – General Areas</u>	<u>All assigned work areas on any vessel or vessel section</u>	<u>5</u>	<u>54</u>

Note:

Table 7-1 is provided as a limited reference of areas and requirements and is not all inclusive.

7-10. Checklists and Forms.

Not Applicable.

Chapter 8

Accident Prevention Signs, Tags, Labels, Signals, and Traffic Control

8-1. References.

a. American Society of Mechanical Engineers (ASME) A13.1, Scheme for the Identification of Piping Systems (<https://webstore.ansi.org/>) (8-1.a)

b. ANSI/National Electrical Manufacturers Association (NEMA) Z535, Safety Alerting Standards (<https://webstore.ansi.org/>) (8-1.b)

c. EP 310-1-6, Graphic Standards Manual (<https://www.publications.usace.army.mil/USACE-Publications/Engineer-Pamphlets/>) (8-1.c)

d. EP 310-1-6a, Sign Standards Manual, Vol 1
(<https://www.publications.usace.army.mil/USACE-Publications/Engineer-Pamphlets/>)
(8-1.d)

e. EP 310-1-6b, Sign Standards Manual, Vol 2
(<https://www.publications.usace.army.mil/USACE-Publications/Engineer-Pamphlets/>)
(8-1.e)

f. ER 1130-2-500, Partners and Support (Work Management Policies) - chapter 6:
Sign Standards Program for Civil Works Projects
(<https://www.publications.usace.army.mil/USACE-Publications/Engineer-Regulations/>)
(8-1.f)

g. Department of Transportation (DOT), Federal Highway Administration's Manual
on Uniform Traffic Control Devices for Streets and Highways (MUTCD)
(<https://mutcd.fhwa.dot.gov>) (8-1.g)

h. 29 CFR 1910.145, Specifications for Accident Prevention Signs and Tags
(<https://www.govinfo.gov/content/pkg/CFR-2020-title29-vol5/pdf/CFR-2020-title29-vol5-sec1910-145.pdf>) (8-1.h)

i. 29 CFR 1926.200, Accident Prevention Signs and Tags
(<https://www.govinfo.gov/content/pkg/CFR-2020-title29-vol8/pdf/CFR-2020-title29-vol8-sec1926-200.pdf>) (8-1.i)

8-2. Definitions.

Not Applicable.

8-3. Personnel Required Qualification/Training.

a. General. All employees must be trained/informed on the meaning of the various signs, tags, and labels used throughout the workplace. (8-3.a)

b. Flaggers. Flaggers must be trained according to the MUTCD and applicable state DOT requirements. (8-3.b)

8-4. Roles and Responsibilities.

a. Supervisors. (8-4.a)

(1) Ensure proper signage is in place and employees are trained/informed on the meaning of the various signs, tags, and labels used throughout the workplace, and on any special precautions that may be required (see para 8-3.a).

(2) Provide, erect, maintain, and remove all traffic signs, barricades, and other traffic control devices necessary for maintenance of traffic.

(3) Use flaggers where required and ensure they are trained in flagging operations according to paragraph 8-3.b and have appropriate PPE before placing them in traffic.

(4) USACE-ONLY. Appoint a USACE Sign Program Manager according to ER 1130-2-500.

b. Employees. All employees must follow signage directives and inform their supervisors of missing, damaged, or obscured signs. (8-4.b)

c. Flaggers. All flaggers must wear appropriate PPE according to chapter 5 and OSHA, to include high-visibility apparel, safety-toed footwear, and hard hats. Flaggers must also communicate with each other and with the foreman, and effectively signal and direct the affected public. (8-4.c)

d. USACE Sign Program Manager (USACE ONLY). The USACE Sign Program Manager is responsible for ensuring compliance with the Sign Standards Program according to ER 1130-2-500, to include approving all orders for signs at civil works projects. (8-4.d)

8-5. Inspection Requirements.

Inspect signage according to the applicable USACE, federal, state, and local requirements.

a. When signage deficiencies are identified, make timely corrections as required or as directed by this manual, applicable federal, state, and local requirements. (8-5.a)

b. Document all inspections according to this manual, applicable federal, state, and local requirements. (8-5.b)

8-6. Activity Hazard Analysis (AHA) Requirements.

Develop AHAs according to paragraphs 1-6 or 2-6, as applicable. Include any required signage, flagging, warning tape, barricade, etc., or other elements as required by this manual, applicable federal, state, and local requirements.

8-7. Minimum Plan Requirements.

A Traffic Control Plan is required when USACE mission (including contractors) affects the normal function of a public or private road. The Traffic Control Plan must be developed by a person knowledgeable in performing temporary traffic control specific to the work being done according to the requirements of the MUTCD and applicable state DOT requirements. The Traffic Control Plan must be developed prior to the commencement of work and include the following:

a. Detailed description of the activity being performed. (8-7.a)

b. Description of anticipated hazards or concerns and the control measure that will be implemented to control to an acceptable level. (8-7.b)

c. Assignment of personnel and their roles and responsibilities. Include necessary information/documentation to support qualification/training of such persons. (See para 8-3) (8-7.c)

d. The complete details of the proposed plan for the maintenance of traffic and access through the contract work area with consideration for the least possible obstruction to the safe and satisfactory movement of traffic. Include details of all required traffic control signage and devices that will provide safety for all road and work area users (for example, contractors, government personnel, motorists, bicyclists, and pedestrians within the highway or on public roads open to public travel). (8-7.d)

e. Any required coordination with adjacent projects, potentially affected stakeholders, and external agencies (for example, law enforcement, highway agencies, businesses). (8-7.e)

f. Proposed placement of signage. (8-7.f)

g. The number of flag and/or signal persons that will be used to control traffic within the work area. (8-7.g)

h. Minimum PPE requirements for all personnel on the work site (see chapter 5). (8-7.h)

i. Procedures for coordination requirements for road closings with appropriate local authorities. (8-7.i)

j. Inspection and oversight methods to ensure adherence to the plan. (8-7.j)

8-8. General Requirements.

a. General Sign, Tag, and Label Requirements. (8-8.a)

(1) All signs, tags, and labels must meet this manual, applicable federal, state, and local requirements (for example, OSHA, ANSI, NFPA, MUTCD). It is the responsibility of the employer to meet the correct safety standard for the type of facility or job they are working on.

Note. Temporary use of signs, tags, and labels on a USACE project may meet OSHA or ANSI standards.

Note. USACE facilities must use signs according to EP 310-1-6a.

(2) Provide signs, tags, and labels to give adequate warning and caution of hazards. They are provided to instruct and direct workers and the public.

(3) All signs, tags, and labels must be visible at all times when the hazard or problem exists. Remove or cover them when the hazard or problem no longer exists.

(4) Locate signs, tags, and labels as close as safely possible to their respective hazards. Affix tags by a positive means (such as wire, string, or adhesive) that prevents their loss or unintentional removal.

(5) Signs, tags, and labels must be legible and in English.

(a) In areas where a significant percentage of the workforce or the visiting population speaks primarily in a foreign language, the use of symbol signs is strongly encouraged.

(b) When no symbols exist or where words are essential, two signs, one in English and one in the foreign language, should be placed side by side with the English sign placed on the left side. Each of the two signs must follow the same format (that is, same overall size, letter size and style, color, and mounting). More than one language should never appear on the same sign.

(c) Legends for non-English signs, because of variations in dialect, must be developed at the local level.

b. Sign Requirements. (8-8.b)

(1) Place safety signs to alert and inform the viewer within a sufficient timeframe to take appropriate evasive actions and to avoid potential harm from the hazard according to this manual, applicable federal, state, and local requirements. Signs must be legible, intuitive, and non-distracting to the viewer. Placement of signs should not create additional hazards. Signs must be fabricated with retro-reflective sheeting, as appropriate for adequate visibility under normal and emergency operating conditions.

(2) Safety sign finishes must be of durable materials with colors according to the USACE Sign Standards Manual (that is, EP 310-1-6a and EP 310-1-6b) or ANSI Z535.1.

(3) Furnish signs with rounded or blunt corners that are free from sharp edges, burrs, splinters, or other sharp projections. The ends or heads of bolts or other fastening devices must be installed and maintained so that they do not present a hazard.

(4) The type of sign or tag used in a particular situation must be appropriate for the degree of hazard or intent of message.

(5) Place Warning signs on unattended government-owned floating plant and land-based heavy equipment accessible to the public. The Warning sign must read “No Trespassing – U.S. Government Property.”

(6) Place a slow-moving vehicle emblem/sign on vehicles or equipment that, by design, move at 25 mph (40 km/h) or less that travel on public roads.

Note. USACE employees must follow the USACE Sign Standards Manual. If a sign with a unique legend for Danger, Warning, or Caution is needed, follow the USACE Sign Standards Manual instruction to request approval for a nonstandard safety sign. The sign legend must be concise, easy to read, and contain enough information to be easily understood. Text for custom (that is, other than Danger, Warning, or Caution) signs must be approved by the local USACE Sign Manager.

(7) Signs required to be seen at night must be retroreflective.

c. Sign Types. (8-8.c)

(1) DANGER Signs. Use Danger signs when the circumstances indicate an imminently hazardous situation that, if not avoided, will result in death or serious injury.

(2) WARNING Signs. Use Warning signs when the circumstances indicate a potentially hazardous situation that, if not avoided, could result in death or serious injury. The hazards may be the same as those associated with Danger signs but are of significantly less magnitude.

(3) CAUTION Signs. Use Caution signs when circumstances indicate a potentially hazardous situation that, if not avoided, may result in a minor or moderate injury. It may also be used to alert against unsafe practices that may result in property damage. The hazards may be the same as those associated with Danger signs but are of significantly less magnitude.

(4) NOTICE Signs. Use Notice signs to indicate a statement of company/organizational (for example, USACE offices, contractors) policy directly or indirectly related to the safety of personnel or protection of property. The signal word should not be associated directly with a hazard or hazardous situation, and must not be used in place of Danger, Warning, or Caution. These signs are used to control or define access and circulation. They are used primarily for information and are not placed to identify a hazard.

(5) SAFETY Signs. Use general safety signs to indicate general instructions relative to safe work practices, remind of proper safety procedures, or indicate the location of safety equipment. These signs identify rules and facilities relating to health, first aid, medical equipment, sanitation, housekeeping practice, and general safety information.

(6) Fire safety signs must conform to applicable NFPA requirements.

(7) Use RF radiation hazard warning signs according to ANSI Z535.2.

(8) Use ionizing radiation warning signs, labels, and signals according to the applicable ANSI and Institute of Electrical and Electronic Engineers (IEEE) standards.

d. Tags and Labels. (8-8.d)

(1) Label, tag, or mark each container of hazardous material (see chapter 6).

(2) Use accident prevention tags only as a temporary means of warning employees of an existing hazard (for example, defective tools, equipment, caution orders, tags for HEC).

(3) Tags must contain a signal word (that is, Danger, Warning, Caution) and a major message (presented in either pictographs, written text, or both) to indicate the specific hazardous condition or the instruction to be communicated to the employee. The signal word must be readable at a minimum distance of 5 feet (1.5 m), or such greater distance as warranted by the hazard.

(4) Identify piping systems (for example, pipes, fittings, valves, and pipe coverings) according to ASME A13.1 color scheme and directional flow requirements.

e. Traffic Control. Traffic control is extremely important on highways, in residential areas and at construction sites. When traffic may pose a hazard to operations, public roads must be closed. If passing traffic will likely be affected by a USACE mission/contract, a Traffic Control Plan appropriate to the complexity of the work must be prepared according to paragraph 8-7. (8-8.e)

(1) Coordinate road closings with the USACE supervisor/KO or COR and appropriate local agencies, and obtain, in writing, approval and required permits prior to closing or restricting any roads. Contractors must keep the KO or COR apprised of any such closing as early as possible.

(2) Conduct traffic control, traffic flagging, and signage procedures according to the MUTCD.

(3) All barricades, warning signs, lights, temporary signals, other devices, flagmen, and signaling devices must meet or exceed the minimum requirements of this manual, applicable federal, state, and local requirements.

(4) In construction areas, post legible traffic signs in advance of and/or at points of hazard according to the MUTCD.

(5) Erect required barricades, and signage (for example, Danger, Warning, Detour) before closing any roads.

(6) When roads are temporarily closed to public access, use barricades or gates that are highly visible in day or night conditions according to the MUTCD and other applicable requirements.

(7) Post appropriate warning signs on affected roads at least 100 feet (30.5 m) before the barrier according to the MUTCD or USACE Sign Standards Manual (that is, EP 310-1-6a and EP 310-1-6b). Size and placement of signs depend on viewing distance and speed limit of roadway.

f. Signal and Flagging Systems, Personnel, and Procedures. (8-8.f)

(1) For marine signals, see chapter 19.

(2) For LHE and helicopter hand signals, see chapter 16 of this manual.

(3) Protect signal systems against unauthorized use, breakage, weather, or interference. Stop all work if the system malfunctions.

8-9. Figures and Tables.

Not Applicable.

8-10. Checklists and Forms.

Not Applicable.

Chapter 9 Fire Prevention and Protection

9-1. References.

a. EP 1130-2-540, Environmental Stewardship and Maintenance Guidance and Procedures (<https://www.publications.usace.army.mil/USACE-Publications/Engineer-Pamphlets/>) (9-1.a)

b. International Code Council, International Building Code (IBC) (<https://www.iccsafe.org/>) (9-1.b)

c. National Interagency Fire Center, Interagency Standards for Fire and Fire Aviation Operations, 'Redbook' (https://www.nifc.gov/policies/pol_ref_redbook.html) (9-1.c)

- d. NFPA 10, Standard for Portable Fire Extinguishers (<https://www.nfpa.org/codes-and-standards/all-codes-and-standards/list-of-codes-and-standards/detail?code=10>) (9-1.d)
- e. NFPA 30, Flammable and Combustible Liquids Code (<https://www.nfpa.org/codes-and-standards/all-codes-and-standards/list-of-codes-and-standards/detail?code=30>) (9-1.e)
- f. NFPA 30A, Code for Motor Fuel Dispensing Facilities and Repair Garages (<https://www.nfpa.org/codes-and-standards/all-codes-and-standards/list-of-codes-and-standards/detail?code=30A>) (9-1.f)
- g. NFPA 51B, Standard for Fire Prevention During Welding, Cutting, and Other Hot Work (<https://www.nfpa.org/codes-and-standards/all-codes-and-standards/list-of-codes-and-standards/detail?code=51B>) (9-1.g)
- h. NFPA 58, Liquefied Petroleum Gas Code (<https://www.nfpa.org/codes-and-standards/all-codes-and-standards/list-of-codes-and-standards/detail?code=58>) (9-1.h)
- i. NFPA 70, National Electrical Code (NEC) (2020) (<https://www.nfpa.org/Codes-and-Standards>) (9-1.i)
- j. NFPA 241, Standard for Safeguarding Construction, Alteration, and Demolition Operations (<https://www.nfpa.org/codes-and-standards/all-codes-and-standards/list-of-codes-and-standards/detail?code=241>) (9-1.j)
- k. NFPA 386, Standard for Portable Shipping Tanks for Flammable and Combustible Liquids (<https://www.nfpa.org/codes-and-standards/all-codes-and-standards/list-of-codes-and-standards/detail?code=386>) (9-1.k)
- l. NFPA 600, Standard on Facility Fire Brigades (<https://www.nfpa.org/codes-and-standards/all-codes-and-standards/list-of-codes-and-standards/detail?code=600>) (9-1.l)
- m. NFPA 1051, Standard for Wildland Firefighting Personnel Professional Qualifications (<https://www.nfpa.org/codes-and-standards/all-codes-and-standards/list-of-codes-and-standards/detail?code=1051>) (9-1.m)
- n. NFPA 1142, Standard on Water Supplies for Suburban and Rural Firefighting (<https://www.nfpa.org/codes-and-standards/all-codes-and-standards/list-of-codes-and-standards/detail?code=1142>) (9-1.n)
- o. NFPA 1143, Standard for Wildland Fire Management (<https://www.nfpa.org/codes-and-standards/all-codes-and-standards/list-of-codes-and-standards/detail?code=1143>) (9-1.o)

p. NFPA 1710, Standard for the Organization and Deployment of Fire Suppression Operations, Emergency Medical Operations, and Special Operations to the Public by Career Fire Departments (<https://www.nfpa.org/codes-and-standards/all-codes-and-standards/list-of-codes-and-standards/detail?code=1710>) (9-1.p)

q. NFPA 1720, Standard for the Organization and Deployment of Fire Suppression Operations, emergency Medical Operations, and Special Operations to the Public by Volunteer Fire Departments (<https://www.nfpa.org/codes-and-standards/all-codes-and-standards/list-of-codes-and-standards/detail?code=1720>) (9-1.q)

r. NFPA 1977, Standard on Protective Clothing and Equipment for Wildland Fire Fighting and Urban Interface Fire Fighting (<https://www.nfpa.org/codes-and-standards/all-codes-and-standards/list-of-codes-and-standards/detail?code=1977>) (9-1.r)

s. NFPA 2010, Standard for Fixed Aerosol Fire-Extinguishing Systems (<https://www.nfpa.org/codes-and-standards/all-codes-and-standards/list-of-codes-and-standards/detail?code=2010>) (9-1.s)

t. OSHA's Nationally Recognized Testing Laboratory (NRTL) Program (<https://www.osha.gov/nationally-recognized-testing-laboratory-program>) (9-1.t)

u. UFC 3-600-01, Fire Protection Engineering for Facilities (<https://www.wbdg.org/ffc/dod/unified-facilities-criteria-ufc>) (9-1.u)

v. UFC 3-601-02, Fire Protection Systems Inspection, Testing, and Maintenance (<https://www.wbdg.org/ffc/dod/unified-facilities-criteria-ufc>) (9-1.v)

w. 29 CFR 1910.110, Storage and Handling of Liquefied Petroleum Gases (<https://www.govinfo.gov/content/pkg/CFR-2019-title29-vol5/pdf/CFR-2019-title29-vol5-sec1910-110.pdf>) (9-1.w)

x. 29 CFR 1910.156, Fire Brigades (<https://www.govinfo.gov/content/pkg/CFR-2022-title29-vol5/pdf/CFR-2022-title29-vol5-sec1910-156.pdf>) (9-1.x)

9-2. Definitions.

a. Extinguisher Classification. The letter classification given to an extinguisher to designate the classes of fire on which it will be effective. (9-2.a)

b. Extinguisher Rating. The numerical rating given to an extinguisher that indicates the extinguishing potential of the unit. (9-2.b)

c. Fire Cut-Offs. Building features (for example, fire walls, automatic fire doors) designed to retard or restrict the spread of a fire within the building. (9-2.c)

d. Fixed Extinguishing System. A permanently installed system that either extinguishes or controls a fire. (9-2.d)

e. Flammable Liquid. Any liquid having a flashpoint at or below 199.4°F (93°C). Flammable liquids are divided into four categories as follows: (9-2.e)

(1) Category 1 includes liquids having flashpoints below 73.4°F (23°C) and having a boiling point at or below 95°F (35°C).

(2) Category 2 includes liquids having flashpoints below 73.4°F (23°C) and having a boiling point above 95°F (35°C).

(3) Category 3 includes liquids having flashpoints at or above 73.4°F (23°C) and at or below 140°F (60°C).

(4) Category 4 includes liquids having flashpoints above 140°F (60°C) and at or below 199.4°F (93°C).

f. Fume. Very small suspended solid particles created by condensation from the gaseous state. (9-2.f)

g. Hot Work. Hot work is considered any activity that generates or has the potential to generate, heat, sparks, open flame, or explosion (for example, hot riveting, welding, burning, abrasive blasting, brazing, cutting, grinding, powder-actuated tools, soldering). Grinding, drilling, abrasive blasting, or similar spark-producing operations are also considered hot work except when such operations are isolated physically from any atmosphere containing more than 10% of the lower explosive limit (LEL) of a flammable or combustible substance. (9-2.g)

h. Hot Work Permit. Written authorization to perform hot work operations. (9-2.h)

i. Incipient Stage Fire. A fire that is in the initial or beginning stage and that can be controlled or extinguished by portable fire extinguisher, Class II standpipe, or small hose systems without the need for protective clothing or breathing apparatus. (9-2.i)

j. Prescribed Fire. Any fire ignited to meet specific management objectives. (9-2.j)

k. Qualified Person (QP), Fire Protection Systems, Inspection, Testing and Maintenance. An individual who meets the criteria of a QP as defined in UFC 3-601-02. (9-2.k)

l. Sprinkler System. A system of piping designed according to fire protection engineering standards and installed to control or extinguish fires. The system includes an adequate and reliable water supply, a network of specialty sized piping and

sprinklers that are interconnected, a control valve, and device for actuating an alarm when the system is in operation. (9-2.l)

m. Wildland Fire. A planned or unplanned fire involving wildland fuels. (9-2.m)

9-3. Personnel Required Qualification/Training.

a. Fueling Heaters. Train personnel involved in fueling heaters so that they are thoroughly familiar with the manufacturer's instructions for safe fueling procedures. (9-3.a)

b. Kettle Operators. Train kettle operators in the proper operation of the kettle so that they have knowledge of the material being heated therefore not to allow the material to be heated beyond the allowable temperature. (9-3.b)

c. Portable Fire Extinguishers. When portable fire extinguishers are provided for employee use in the workplace, the employer must provide training upon initial employment and at least annually thereafter to employees who are responsible for their use in the general principles of fire extinguisher use and the hazards involved with incipient stage firefighting. (9-3.c)

d. Wildland Firefighting. (9-3.d)

(1) Employees that may encounter incipient stage wildland fires must be trained upon initial employment and at least annually thereafter in approved firefighting techniques commonly used to extinguish incipient stage wildland fires and the hazards associated with such firefighting activities.

(2) Wildland Fire Management Teams. All wildland fire management team personnel must be trained and qualified according to NFPA 1051 and 1143, to include training in fire line safety, basic wildland fire behavior, basic wildland fire suppression tactics, communications procedures, first aid and use, and limitations and care of protective and firefighting equipment.

(3) Employees engaged in fire management activities must be examined by a physician and obtain certification that they are physically able to perform assigned fire management duties.

e. Firefighting Organizations. Firefighting organizations must be trained according to NFPA 1710 and 1720. (9-3.e)

(1) Fire brigade drills must be held according to 29 CFR 1910.156 to assure a well-trained and efficient operating force. Maintain record of drills.

(2) Conduct demonstrations and training in first aid according to chapter 3 and firefighting at intervals to ensure that project personnel are familiar with and capable of operating firefighting equipment.

f. Fire Prevention Plan. All employees must be trained on the contents of their site-specific Fire Prevention Plan to include the following: (9-3.f)

(1) The fire hazards and the materials and processes to which they are exposed.

(2) Emergency evacuation procedures.

(3) The preferred means of reporting emergencies, such as manual pull box alarms, public address systems, or telephones.

9-4. Roles and Responsibilities.

A Qualified Person (QP) for Fire Protection Systems, Inspection, Testing and Maintenance will:

a. Conduct surveys, including an annual survey, of the suitability and effectiveness of fire prevention and protection measures and facilities at each project or installation according to UFC 3-601-02. Retain records of the survey findings and recommendations on file at the project or installation. (9-4.a)

b. Service, test, maintain, or repair fire detection alarm, and mass notification systems. (9-4.b)

9-5. Inspection Requirements.

a. Portable Fire Extinguishers. Inspect and maintain fire extinguishers according to NFPA 10. Inspect fire extinguishers at least monthly. Keep records on a tag or label attached to the extinguisher on an inspection check list maintained on file, or by an electronic method that provides a permanent record. The record/tag must include date inspection was performed and initials of the person performing the inspection. (9-5.a)

Note. For any extinguishers that do not require an annual internal examination, designate a person/s to perform annual maintenance check of fire extinguishers. If deficiencies are found that would require the emptying of extinguishing agent or the release of pressure to correct, the extinguisher deficiency must be corrected by a certified fire extinguisher technician per NFPA 10.

b. Fixed Fire Suppression Systems. Inspect and maintain fixed fire suppression systems according to UFC 3-601-02. Fixed fire suppression systems that are not addressed in the UFC should be inspected and maintained according to the applicable NFPA standards. Record inspection and maintenance dates on the container, on a tag attached to the container, or in a central location. (9-5.b)

c. Standpipe and Hose Systems. (9-5.c)

(1) Inspect and maintain standpipe systems according to UFC 3-601-02.

(2) Inspect hose systems after each use and at least annually to assure that all equipment is in place, available for use, and in operable condition.

(3) Un-rack hemp and linen hoses and physically inspect them for deterioration at least annually, and re-rack them using a different fold pattern.

(4) When the system or any portion of the system is found not to be serviceable, remove it for repair and replace it with equivalent protection (for example, fire watch, extinguisher) until the repairs are complete.

9-6. Activity Hazard Analysis (AHA) Requirements.

Develop AHAs according to paragraphs 1-6 or 2-6, as applicable.

a. AHAs are required when conducting wildland fire prescribed burns (see paras 9-7.b and 9-8.l). (9-6.a)

b. Employer will determine how long a fire watch is required to stay in place, but it must be a minimum of thirty (30) minutes after the exposure has ended and documented in the AHA (see para 9-8.g). (9-6.b)

9-7. Minimum Plan Requirements.

a. Fire Prevention Plan. A Fire Prevention Plan is required at all USACE facilities and project sites. For construction operations, develop according to NFPA 241, and for marine operations, develop according to chapter 19. All plans must include the following: (9-7.a)

(1) Detailed description of activities performed where fire hazards are present or generated during the course of such activities.

(2) Description of anticipated hazards, to include the following:

(a) A list of the major workplace fire hazards.

(b) Potential ignition sources.

(c) Control measures that will be implemented to control to an acceptable level, to include housekeeping procedures (for example, removal of waste materials) and the types of fire suppression equipment or systems appropriate to control a fire.

(3) Assignments of personnel and their roles and responsibilities, to include responsibilities for maintaining fire suppression equipment or systems and controlling

fuel source hazards. Include necessary information/documentation to support qualifications/training of such persons. (See para 9-3)

(4) Inspection and oversight methods to ensure adherence to the plan.

b. Wildland Fire Management Plan. A Wildland Fire Management Plan is required at all USACE facilities and project sites with potential exposure to wildland fire, whether prescribed or planned. Plans must be reviewed and updated at least annually. Plans must address prescribed fire and wildfire prevention and suppression to include the following: (9-7.b)

Note. USACE only. Develop plans according to EP 1130-2-540.

(1) Detailed description of activity being performed, to include individual prescribed fire burn plan procedure and AHA.

(2) Description of anticipated hazards or concerns and the control measures that will be implemented to control to an acceptable level, to include the following:

(a) An analysis of wildland fire causes and special wildland fire hazards and risks.

(b) Proposed measures to reduce wildfire occurrence and decrease fire damage.

(c) Procedures for public education and notification and wildfire prevention sign posting, including procedures for keeping the public informed of the current fire danger rating.

(d) Provisions for cooperative efforts with all other neighboring wildland fire management protection agencies.

(e) A listing of cooperating agencies (including any mutual aid agreements with adjacent fire departments and agencies) and notification procedures for both them and the in-house wildland fire management or control team.

(f) A listing of additional available resources for work force, equipment, supplies, and facilities, and contracting or procurement information.

(g) An up-to-date map(s) of the managed and/or protected area(s) that shows boundaries, roads, and other means of access, heliports, airports, water sources, special hazards, and special fire risks.

(h) A listing of weather information sources.

(i) A pre-attack fire suppression plan.

(j) Conduction of onsite safety meetings to discuss predicted weather patterns, escape route(s), and safety zone(s).

(3) Assignment of personnel and their roles and responsibilities, to include the in-house wildland fire management or control team organization and personnel roster, training, and equipment requirements. Include necessary information/documentation to support qualification/training of such persons. (See para 9-3)

(4) Inspection and oversight methods to ensure adherence to the plan.

9-8. General Requirements.

Follow applicable NFPA recommendations in situations not covered in this chapter. When unusual fire hazards exist or fire emergencies develop, provide additional protection as required by the USACE supervisor/KO or COR.

a. Fire Prevention. (9-8.a)

(1) Fire Prevention Plan. A Fire Prevention Plan must be developed for all USACE facilities and project sites according to paragraph 9-7.a. All employees must be trained on the plan according to paragraph 9-3.f. Use the plan to brief emergency first responders on the fire hazards, the materials and processes, and the emergency evacuation procedures.

(2) Do not leave fires and open flame devices unattended.

(3) Separate all sources of ignition, including smoking, at least 50 feet (15.2 m) from any operations with a potential fire hazard or areas where flammable, combustible, or oxidizing materials are stored. Conspicuously post with legible signs stating, "NO SMOKING, MATCHES, or OPEN FLAME."

(4) Segregate DOT-identified noncompatible materials that may create a fire hazard with a barrier having a fire resistance rating equivalent to a listing of at least one hour. See chapter 20 for compressed gas cylinders.

(5) Do not install low-density fiberboard, combustible insulation, or vapor barriers with a flame spread greater than 25 inches in permanent buildings.

(6) Space temporary buildings according to the IBC.

(7) Shield all combustibles from all types of hot work activities.

(8) Take precautions to protect formwork and scaffolding from exposure to and spread of fire.

(9) Control the growth of tall grass, brush, and weeds adjacent to facilities. Maintain a break of at least 3 feet (0.9 m) around all facilities.

(10) Maintain sufficient clearance around lights and heating units to prevent ignition of combustible materials.

(11) Housekeeping.

(a) Promptly remove and dispose of accumulations of combustible scrap and debris.

(b) Use self-closing containers to collect waste saturated with flammable liquids.

(c) Use non-combustible or Underwriters Laboratories (UL)-labeled nonmetallic containers to dispose of waste and rubbish.

b. Fire Protection. (9-8.b)

(1) When outside help is relied upon for fire protection, prepare a written agreement or a memorandum of record stating the terms of the arrangement and the details for fire protection services and provide it to the USACE supervisor/KO or COR.

(2) Provide and maintain water supply and distribution facilities for firefighting according to NFPA 1142.

(3) Establish and maintain fire lines that are free of obstructions and provide access to all areas.

(4) Do not permit vehicles, equipment, materials, and supplies to obstruct access to fire hydrants and other firefighting equipment.

(5) Portable Fire Extinguishers. Provide portable fire extinguishers according to table 9-2.

(a) All portable fire extinguishers must be approved by a NRTL and labeled to identify the listing and labeling organization and the fire test and performance standard that the fire extinguisher meets or exceeds.

(b) All portable fire extinguishers must be marked with their extinguisher classification and rating.

(c) Fire extinguishers must be suitably placed, distinctly marked, and readily accessible. All fire extinguishers must be fully charged and in operable condition.

(d) Inspect fire extinguishers according to paragraph 9-5.a.

(e) When fire extinguishers are provided in the workplace, employees must be trained according to paragraph 9-3.c.

(f) Do not use fire extinguishers with carbon tetrachloride or bromochloromethane extinguishing agents.

(g) Do not use soldered or riveted shell self-generating foam or gas cartridge water-type portable extinguishers that are operated by inverting the extinguisher to rupture or initiate an uncontrollable pressure generating chemical reaction to expel the agent.

(6) Standpipe and Hose System Equipment.

(a) The design and construction of standpipes must be according to UFC 3-600-01.

(b) Locate standpipes or otherwise protect them against damage. Promptly repair damaged standpipes.

(c) Design and maintain reels and cabinets used to contain fire hose to ensure easy access to the hose valve, hose, and other equipment. Conspicuously identify reels and cabinets and only use them for fire equipment.

(d) Locate hose outlets and connections high enough above the floor to avoid their obstruction and to be accessible to employees. To ensure hose connections are compatible with support fire equipment, standardize the screw threads or provide adapters throughout the system.

(e) Equip standpipe systems with vinyl type or lined hoses of such length that friction loss resulting from water flowing through the hose will not decrease the pressure at the nozzle below 30 psi (206.8 kilopascal (kPa)) gauge. The dynamic pressure at the nozzle will be within 30 psi (206.8 kPa) gauge and 125 psi (861.8 kPa) gauge.

(f) Equip standpipe hoses with basic spray nozzles with a straight stream to wide stream spray pattern. Nozzles must have a water discharge control capable of functions ranging from full discharge to complete shutoff.

(g) Perform the following tests on standpipe and hose systems before placing them in service:

(g-1) Hydrostatically test piping (including yard piping) for at least two hours at not less than 200 psi (1379 kPa), or at least 50 psi (344.7 kPa) more than normal pressure when the normal pressure is greater than 150 psi (1034.2 kPa).

(g-2) Hydrostatically test hose with couplings in place at a pressure of not less than 200 psi (1379 kPa). Maintain this pressure for at least 15 seconds, but not more than one minute, during which time the hose must not leak or the jacket thread break.

(h) Keep water supply tanks filled to the proper level except during repairs. When pressure tanks are used, always maintain proper pressure except during repairs.

(i) Always keep valves in the main piping connections to the automatic sources of water supply fully open, except during repairs.

(j) Inspect the system according to paragraph 9-5.c.

(k) The minimum water supply for standpipe and hose systems provided for the use of employees must provide at least 100 gal (0.38 m³) per minute for at least 30 minutes.

(l) For all structures in which standpipes are required, or where standpipes exist in structures being altered, install the standpipes as soon as practical and maintain them as construction progresses so that they are always ready for fire protection use. There must be at least one standard hose outlet at each floor.

(7) Fixed Fire Suppression Systems.

(a) Design, install, and acceptance test fixed fire suppression systems according to the requirements of the UFC 3-600-01.

(b) Inspect the system according to paragraph 9-5.b.

(c) Protect automatic sprinkler systems from damage.

(d) Maintain a vertical clearance of at least 18 inches (45.7 cm) between the top of stored material and sprinkler deflectors.

(e) If a fixed extinguishing system becomes inoperable, the employer must notify the employees and take necessary precautions to assure their safety until the system is restored to operating order.

(f) Provide effective safeguards to warn employees against entry into fixed extinguishing system discharge areas where the atmosphere remains hazardous to employee safety and health. Identify manual operating devices as to the hazard against which they will provide protection.

(g) Post warning or caution signs at the entrance and inside the areas protected by fixed extinguishing systems that use agents in concentrations known to be hazardous to employee safety and health.

(8) Dry Chemical Fixed Extinguishing Systems.

(a) Dry chemical extinguishing agents must be compatible with any foams or wetting agents with which they are used.

(b) Do not mix dry chemical extinguishing agents of different compositions.

(c) Refill dry chemical extinguishing systems with the chemical stated on the approval nameplate or an equivalent compatible material.

(9) Gaseous Agent Fixed Extinguishing Systems.

(a) Agents used for initial supply and replenishment must be of a type approved for the system's application.

(b) Do not expose employees to toxic levels of the gaseous agent or its decomposition products.

(10) When water and spray foam fixed extinguishing systems are used, drain the water away from work areas and emergency egress routes.

(11) When fire blankets are provided, keep them in a conspicuous and accessible location.

c. Fire Fighting. (9-8.c)

(1) Do not attempt to fight a fire that is in imminent danger of contact with explosives. Relocate all employees to a safe area and guard the fire against intruders.

(2) Firefighting Equipment.

(a) Provide and install firefighting equipment according to applicable NFPA and OSHA regulations (see para 9-1).

(b) Do not make any fire protection equipment or device inoperative or use them for other purposes, unless specifically approved by the USACE supervisor or accepted by the KO or COR.

(c) If fire hose connections are not compatible with local firefighting equipment, adapters must be made available.

d. Fire Alarm and Mass Notification Systems. The employer must establish an alarm system so that employees onsite and the local fire department can be alerted of an emergency. (9-8.d)

(1) Design, install, and maintain fire alarm and mass notification systems according to UFC 3-600-01 and UFC 3-601-02.

(2) Restore fire detection systems and components to normal operating condition as soon as possible after each test or alarm. Maintain spare devices and components in sufficient quantities for prompt system restoration.

(3) Maintain fire detection systems in operable condition, except during maintenance or repairs. Only a QP, will service, test, maintain, or repair fire detection, alarm, and mass notification systems. (See para 9-4)

(a) Test and adjust fire detectors and detector systems as often as necessary to maintain operability and reliability. Factory calibrated detectors do not need to be adjusted after installation.

(b) Clean fire detectors of dirt, dust, or other particulate matter at regular intervals according to the manufacturer's instructions to be fully functional.

(4) Equip pneumatic and hydraulic operated detection systems installed after January 1, 1981, with supervised systems.

(5) Protect fire detection systems and devices from weather, corrosion, and mechanical and physical damage.

(6) Do not support fire detectors from their control wiring or conduit.

(7) Manually operated alarm actuation devices must be conspicuous, accessible, and inspected and maintained in operable condition.

(8) The alarm must be distinctive and recognizable as a signal to evacuate the work area or to perform actions designated in the Emergency Plan according to paragraphs 1-7.d or 2-8.d, as applicable. The alarm must be capable of being perceived above ambient noise and light levels by all employees in the affected area. Tactile devices must be used to alert those employees who would not otherwise be able to recognize the audible or visual alarm.

(9) Instruct employees in the preferred means of reporting emergencies, such as manual pull box alarms, public address systems, or telephones (see para 9-3.f).

(a) Post the alarm code and reporting instructions in conspicuous locations such as at phones and at employee entrances.

(b) Post evacuation instructions in a conspicuous location.

(10) For work at installations that are equipped with radio wave fire alarm systems, a compatible fire alarm transmitter should be used at the construction site.

(11) Install and maintain smoke detectors where personnel are quartered.

e. Hot Work. Prior to performing any hot work, survey the work area to ensure they are free from fire hazards. (9-8.e)

(1) Hot Work Permits. The USACE supervisor/KO or COR must survey all activities and determine which require a hot work permit. Hot work permits are required when performing hot work. Hot work permits must include the date(s) authorized for hot work and identify the objects on which the hot work is to be performed. Permits must be kept on file until the completion of the hot work.

Note. See NFPA 51B for a sample hot work permit.

(2) All hot work and hot work permits must conform to local policy when present.

(3) Fire Watches. Where combustible materials have been exposed to fire hazards, employer will determine how long a fire watch is required to stay in place, but it must be a minimum of thirty (30) minutes after the exposure has ended and documented in the AHA. Where fire watch personnel or guards are provided, they must make frequent rounds through buildings and storage areas when work is suspended.

(4) A fully charged fire extinguisher, minimum 10 lbs. (4.5 kg), must be readily available in the immediate area of the hot work.

(5) Install and maintain smoke detectors where personnel are quartered.

(6) Hot work is prohibited in the following areas:

(a) In areas not authorized by USACE supervisor/KO or COR.

(b) In sprinklered buildings while such protection is impaired unless equivalent protection is provided for the hot work and approved by the USACE supervisor or accepted by the KO or COR.

(c) In the presence of explosive atmospheres, areas where an explosive atmosphere may develop, or where there is an accumulation of combustible dust.

(d) In areas near the storage of large quantities of exposed, readily ignitable materials such as bulk sulfur, baled paper, or cotton.

f. Burning Operations. (9-8.f)

(1) Establish burning areas in coordination with the USACE supervisor/KO or COR and with the agency responsible for monitoring fire potential at the location of the proposed burning area.

(2) All burning operations must comply with this manual, applicable federal, state, and local requirements.

(3) Maintain a sufficient force to control and patrol the burning operations until the last embers have been extinguished.

(4) Provide bump blocks where trucks back-up to a fire or burning pit.

(5) Conduct prescribed burning activities for natural resource management according to paragraph 9-8.i.

g. Hazardous Locations. (9-8.g)

(1) Only use electrical lighting as a means of artificial illumination in areas where flammable liquids, vapors, fumes, dust, or gases are present.

(2) All electrical equipment and installations in hazardous locations must comply with the NEC for hazardous locations.

(3) Do not remove or replace globe(s) lamp(s) or make repairs on the electrical circuit until it has been de-energized (see chapter 12).

(4) All miners' lights and flashlights used around explosives or in atmospheres likely to contain explosive vapors, dusts, or gases must be approved by a private sector organization recognized by OSHA's NRTL Program.

h. Fire Protection in the Construction Process. (9-8.h)

(1) Retain fire cut-offs in buildings undergoing alterations or demolition until operations require their removal.

(2) Where a water distribution system is required for the protection of buildings or other structures, install water mains and hydrants before or concurrent with the construction of facilities. Until the permanent system is in operation, an equivalent temporary system must be provided.

(3) Install permanent (fixed) and functioning extinguishing equipment and water supply for fire protection as soon as possible. The scheduling of sprinkler installation must closely follow the building construction and, following completion of each story, must be placed in service as soon as possible.

(4) During demolition or alterations, retain service to the existing automatic sprinkler systems if reasonable. Expedite the modification of sprinkler systems to allow alterations or additional demolition of the system to return service as quickly as possible. Check sprinkler control valves daily at close of work to find out if the protection is still in service. The operation of sprinkler control valves is allowed only when approved by the USACE supervisor or accepted by the KO or COR.

(5) During the construction process, prioritize the construction of fire walls and exit stairways required for completed buildings. Install fire doors, with automatic closing devices, in openings as soon as practical.

i. Temporary Heating Devices. (9-8.i)

(1) The USACE supervisor/KO or COR must approve all temporary heating devices.

(2) Each heater must have a safety data plate permanently affixed by the manufacturer. The plate must show requirements or recommendations for:

- (a) Clearance from combustible materials.
- (b) Ventilation (minimum air requirements for fuel combustion).
- (c) Fuel type and input pressure.
- (d) Lighting, extinguishing, and relighting.
- (e) Electrical power supply characteristics.
- (f) Location, moving, and handling.
- (g) Name and address of the manufacturer.

Note. If this information is not available on a data plate, provide it in writing at the jobsite.

(3) Establish a standard operating procedure to assure the following:

- (a) Proper placement and servicing.
- (b) Safe clearance from combustible material.
- (c) Close surveillance.
- (d) Safe fuel storage and refueling.
- (e) Proper maintenance.
- (f) Ventilation and determination of gaseous contamination or oxygen deficiency.

(4) Install and maintain heaters according to the manufacturer's instructions.

(5) Do not use open-flame heating devices having exposed fuel below the flame.

(6) Operate heaters in a horizontally level position, unless otherwise permitted by the manufacturer's specifications.

(7) Mark heaters that are unsuitable for use on wood floors. When such heaters are used, place them on suitable heat insulating material, such as 1 inch (2.5 cm) minimum thick concrete. The insulating material must extend at least 2 feet (0.6 m) in all directions from the edges of the heater.

(8) Locate heaters used near combustible tarpaulins, canvas, or similar coverings at least 10 feet (3 m) from such coverings. Securely fasten the coverings to prevent them from igniting or upsetting the heater due to the wind.

(9) Protect heaters from damage.

(10) Separate temporary heating devices from combustible materials by the minimum clearances shown in table 9-1.

(11) Train personnel involved in fueling heaters according to paragraph 9-3.a.

(12) Vent fuel combustion space heating devices used in any enclosed building, room, or structure with a flue pipe to the exterior of the structure.

(a) Supply fresh air by natural or mechanical means in sufficient quantities to ensure the health and safety of workers. Give particular attention to areas where heat and fumes may accumulate.

(b) When heaters are used in confined spaces, take precautions to ensure proper combustion, maintenance of a safe and healthful atmosphere for workers, and limitation of temperature rise in the area. Address these concerns on the confined space entry permit. (See chapter 34)

(c) Locate vent pipes at least 18 inches (45.7 cm) from flammables and combustibles. Where vent pipes pass through combustible walls or roofs, properly insulate, and securely fasten and support them to prevent accidental displacement or separation.

(13) When a heater is placed in operation, perform initial and periodic checks to make sure it is functioning properly.

(14) When heaters are used in enclosed or partially enclosed structures, monitor for carbon CO continuously. If not feasible, state in the AHA and perform tests to monitor for the presence of CO within one hour of the start of each shift and at least every 4 hours thereafter. If CO concentrations exceed 25 parts per million (ppm) (TLV) of air volume at worker breathing levels, extinguish the heater or provide additional ventilation to reduce the CO content to acceptable levels.

(15) Heaters must be equipped with an approved automatic device to shut off the flow of fuel if the flame is extinguished. On liquid fuel heaters, barometric or gravity oil feed is not considered a primary safety control.

(16) Spark arresters must be provided on all smokestacks or burning devices having forced drafts or short stacks permitting live sparks or hot materials to escape.

(17) Do not use solid fuel heaters in buildings or on scaffolds.

(18) Gas Heaters.

(a) Leak test all piping, tubing, and hoses using soap suds or other noncombustible detection means after assembly to prove free of leaks at normal operating pressure.

(b) Protect hose and fittings from damage and deterioration.

(c) Check all hoses and fittings to ensure that the type, capacity, and pressure ratings are as specified by the heater manufacturer. Hoses must have a minimum working pressure of 250 psi (1723.7 kPa) gauge and a minimum bursting pressure of 1,250 psi (8618.4 kPa) gauge.

(d) All hose connectors must withstand, without leakage, a test pressure of 125 psi (861.8 kPa) gauge for natural gas, and 500 psi (3,447 kPa) gauge for Liquefied Petroleum (LP)-Gas and withstand a pull test of 400 lbs. (181.4 kg) (see 29 CFR 1910.110).

(e) Securely connect hose connectors to the heater by mechanical means. Do not use "slip-end" connectors (that is, connections that allow the hose end to be held only by the friction of the hose material against the metal fitting of the unit) nor ring keepers (that is, tightened over the hose to provide an increased force holding the hose to the metal fitting).

(19) Natural Gas Heaters. When using flexible gas supply lines, the length must be as short as practical and must not exceed 25 feet (7.6 m).

(20) Portable LP-Gas Heaters (see chapter 14).

(a) If LP-Gas is supplied to a heater by hose, the hose must not be less than 10 feet (3 m), or more than 25 feet (7.6 m), in length.

(b) Equip heaters with an approved regulator in the supply line between the fuel cylinder and the heater unit. Provide cylinder connectors with an excess flow valve to minimize the flow of gas in the event the fuel line ruptures.

(c) Equip LP-Gas heaters having inputs above 50,000 British Thermal Unit (BTU)/hour with either a pilot, which will be lighted and proved before the main burner can be turned on, or an electronic ignition. These provisions do not apply to portable heaters under 7,500 BTU/ hour when used with containers having a maximum water capacity of 2.5 lbs. (1.1 kg).

(d) Do not use container valves, connectors, regulators, manifolds, piping, or tubing as structural support for LP-Gas heaters.

(e) Locate heaters, other than integral heater-container units, at least 6 feet (1.8 m) from any LP-Gas container. This requirement does not prohibit the use of heaters designed specifically for attachment to the LP-Gas container or to a supporting standard, provided they are designed and installed to prevent direct or radiant heat application from the heater into the containers. Do not direct blower or radiant type heaters toward any LP-Gas container located within 20 feet (6.1 m).

(f) If two or more heater-container units (of either the integral or non-integral type) are in the same area of an unpartitioned floor, separate the container or containers of each unit from the container or containers of any other unit by at least 20 feet (6.1 m).

(g) When heaters are connected to containers for use in an unpartitioned area on the same floor, the total water capacity of containers, manifolded together for connection to a heater(s), must not be greater than 735 lbs. (333.4 kg), nominal 300 lbs. (136.1 kg) LP-Gas capacity. Separate such manifolds by at least 20 feet (6.1 m).

(21) Installation of Heating Equipment in Service or Lubrication Areas.

(a) Install heating equipment in lubrication or service areas where there is no dispensing or transferring of flammable liquids so that the bottom of the heating unit is at least 18 inches (45.7 cm) above the floor and is protected from damage.

(b) Where flammable liquids are dispensed, install heating equipment of an approved type for garages at least 8 feet (2.4 m) above the floor.

(22) Do not modify temporary heating devices, use proper purpose only, and follow manufacturer's instruction to use.

j. USACE Wildland Fire Control and Recovery. (9-8.j)

(1) A Wildland Fire Management Plan must be developed according to paragraph 9-7.b at all USACE facilities and project sites with potential exposure to wildland fire, whether prescribed or planned.

(2) Organize and conduct wildland fire management teams and operations according to NFPA 1143.

(a) Wildland fire management team personnel must be trained according to paragraph 9-3.d.

(b) Wildland fire management teams must include at least two qualified individuals (see para 9-3.d).

(3) Maintain firefighting equipment in working and ready condition.

(4) Provide and maintain in working and ready condition PPE according to NFPA 1143 and NFPA 1977, to include fire-resistant clothing, safety hard hats, protective footwear (safety toe required for chainsaw operators and/or crush hazard), leather boots, goggles, and fire-resistant gloves. (See chapter 5)

(5) A physician must examine employees engaged in fire management activities as part of their medical surveillance. The physician must certify that they are physically able to perform assigned fire management duties. (See para 9-3.d)

(6) Provide communication equipment to personnel as necessary for coordination, control, and emergency needs.

(7) Prior to conducting a prescribed burn, a hazard evaluation and exposure assessment must be completed and recorded on the AHA to determine if adequate controls are in place. It is recommended that medical surveillance and exposure monitoring is conducted for volatile organic compounds, nitrogen dioxide, CO, and particulate matter 2.5 microns or less in diameter (PM2.5). (See para 9-6)

k. Heating Devices and Melting Kettles. (9-8.k)

(1) All kettle operators must be trained according to paragraph 9-3.b.

(2) Place heating devices and melting kettles on firm, level, non-combustible foundations, and whenever possible, place downwind from employees or occupied buildings. Protect against traffic, accidental tipping, or similar hazards.

(3) Establish procedures to contain uncontrol spills of heated material which may be on fire. Place a fire-retardant tarp, or other effective means, under the kettle.

(4) Maintain a minimum of two fire extinguishers rated not less than 2A:20B:C within 25 feet (7.6 m) of the working kettles.

(5) Hot work permits are required on government installation unless otherwise indicated by the USACE supervisor/KO or COR (see para 9-8.g).

(6) Provide and ensure use of a working thermometer.

(7) Do not leave heating devices and melting kettles unattended when in use. When the kettle is heating material to the working temperature, the operator must be located on the same level as the kettle and be within eyesight, but no more than 25 feet (7.6 m) from the kettle.

(8) Provide bituminous-material melting kettles with an effective tight-fitting lid or hood and a calibrated thermometer in operating condition.

- (a) The temperature must be maintained 25° below the flash point of the bituminous material.
- (b) All melting kettles must be appropriately sized for the job.
- (c) Do not locate asphalt or tar kettles on roofs.
- (9) Do not use or operate bituminous-material melting kettles inside or within 25 feet (7.6 m) of combustible materials, including propane tanks being stored or in use. The lid for the kettle must open away from the building.
- (10) Keep liquid propane container(s) used as a heat source at least 10 feet (3 m) away from the kettle. Place in an upright and secured position to prevent tip over.
- (11) Locate kettles so that means of egress is not restricted. Kettles must not be placed closer than 10 feet (3 m) of an egress path.
- (12) Ventilate enclosed areas where hot substances are heated or applied.
- (13) All ladles, equipment, and material must be moisture-free before being used or placed in heated material.
- (14) Do not use flammable liquids with a flashpoint below 100°F (37.8°C) to thin the mixture or to clean equipment.
- (15) Include in the Fire Prevention Plan (see paras 9-7.a and 9-3.f).

9-9. Figures and Tables.

**Table 9-1
Temporary Heating Device Clearances**

Heater Type	Sides	Rear	Chimney Connector
Room heater - circulating	12 inches (30.5 cm)	12 inches (30.5 cm)	18 inches (45.7 cm)
Room heater - radiant	36 inches (91.4 cm)	36 inches (91.4 cm)	18 inches (45.7 cm)

**Table 9-2
Fire Extinguisher Distribution**

	Occupancy Low Hazard Class A	Occupancy Low Hazard Class B	Occupancy Medium Hazard Class A	Occupancy Medium Hazard Class B	Occupancy High Hazard Class A	Occupancy High Hazard Class B
Minimum rating for single fire extinguisher	2-A	5-B or 10-B ¹	2-A	10-B or 20-B	4A	40-B or 80-B ²
Maximum coverage (floor area) per unit of A-rating	3,000 ft ² (278.7 m ²)	Not Applicable	1,500 ft ² (139.4 m ²)	Not Applicable	1,000 ft ² (93 m ²)	Not Applicable
Maximum floor area for extinguisher	11,250 ft ² (1045.2 m ²)	Not Applicable	11,250 ft ² (1045.2 m ²)	Not Applicable	11,250 ft ² (1045.2 m ²)	Not Applicable
Maximum travel for distance to extinguisher	75 feet (22.9 m)	30 feet for 5-B or 50 feet for 10-B	75 feet (22.9 m)	30 feet for 10-B or 50 feet for 20-B	75 feet (22.9 m)	30 feet for 40-B or 50 feet for 80-B

Note:

- ¹ Up to three foam extinguishers of at least 2 1/2 gal (9.5 L) capacities will be used to fulfill low hazard requirements.
- ² Up to three aqueous film forming foam (AFFF) extinguishers of at least 2 1/2 gal (9.5 L) capacities may be used to fulfill high hazard requirements.
- ³ Derived from NFPA 10: In multiple-story facilities, at least 1 fire extinguisher will be adjacent to stairways.
- ⁴ On construction and demolition projects, a one-half (1/2) inch (1.2 cm) diameter garden hose, not to exceed 100 feet (30.5 m) in length and equipped with a nozzle, will be substituted for a 2-A rated fire extinguisher provided it is capable of discharging a minimum of 5 gal (18.9 L) per minute with minimum hose stream range of 30 feet (9.1 m) horizontally. The garden hose lines will be mounted on conventional racks or reels. The number and location of hose racks or reels will be such that at least one hose stream can be applied to all points in the area.

9-10. Checklists and Forms.

Not Applicable.

Chapter 10 Welding and Cutting

10-1. References.

- a. American Welding Society (AWS) (<https://www.aws.org/>) (10-1.a)
- b. ANSI/AWS F4.1, Safe Practice for the Preparation of Containers and Piping for Welding, Cut, and Allied Processes (<https://webstore.ansi.org/>) (10-1.b)
- c. ANSI/AWS Z49.1, Safety in Welding, Cutting, and Allied Processes (<https://webstore.ansi.org/>) (10-1.c)
- d. ANSI/ISEA Z87.1, American National Standard for Occupational and Educational Personal Eye and Face Protection Devices (<https://webstore.ansi.org/>) (10-1.d)
- e. NFPA 51, Standard for the Design and Installation of Oxygen-Fuel Gas Systems for Welding, Cutting, and Allied Processes (<https://www.nfpa.org/Codes-and-Standards>) (10-1.e)
- f. NFPA 70, National Electrical Code (NEC) (2020) (<https://www.nfpa.org/Codes-and-Standards>) (10-1.f)
- g. NFPA 326, Standard for the Safeguarding of Tanks and Containers for Entry, Cleaning, or Repair (<https://www.nfpa.org/Codes-and-Standards>) (10-1.g)
- h. 29 CFR 1910, Subpart Q Welding, Cutting and Brazing (<https://www.govinfo.gov/content/pkg/CFR-2019-title29-vol5/pdf/CFR-2019-title29-vol5-part1910-subpartQ.pdf>) (10-1.h)
- i. 29 CFR 1926, Subpart J Welding and Cutting (<https://www.govinfo.gov/content/pkg/CFR-2019-title29-vol8/pdf/CFR-2019-title29-vol8-part1926-subpartJ.pdf>) (10-1.i)
- j. 49 CFR 192, Transportation of Natural and Other Gas by Pipeline: Minimum Federal Safety Standards (<https://www.govinfo.gov/content/pkg/CFR-2019-title49-vol3/pdf/CFR-2019-title49-vol3-part192.pdf>) (10-1.j)

10-2. Definitions.

- a. Arc Welding. A welding process that joins work pieces by heating them with an arc. (10-2.a)

b. Bonding. The permanent joining of metallic parts to form an electrically conductive path that will ensure electrical continuity and capacity to safely conduct any expected current. (10-2.b)

c. Brazing. A welding process that joins ferrous metals materials by heating them to a temperature that will not melt them but will melt a filler material which adheres to them and forms a joint. (10-2.c)

d. Cable. A conductor with insulation, or a stranded conductor with or without insulation and other coverings (for example, single-conductor cable), or a combination of conductors insulated from one another (for example, multiple-conductor cable). (10-2.d)

e. Competent Person (CP). See paragraphs 1-2 or 2-2, as applicable. (10-2.e)

f. Confined Space. See paragraphs 34-2. (10-2.f)

g. Employee. See paragraphs 1-2 or 2-2, as applicable. (10-2.g)

h. Flashback. A backfire of the flame in a mixing chamber of the oxy-fuel gas torch that may progress through the torch and hoses. (10-2.h)

i. Fuel Gas. A gas (for example, acetylene, hydrogen, natural gas, propane) used with oxygen in the oxyfuel process and for heating. (10-2.i)

j. Gas Metal Arc Welding. An arc welding process that uses an arc between a continuous filler metal electrode and the weld pool. Shielding from the atmosphere is provided by an externally supplied gas. (10-2.j)

k. Grounding. See paragraph 11-2. (10-2.k)

l. Hot Tapping. A procedure of attaching connections to equipment in service by welding and drilling. (10-2.l)

m. Hot Work. Hot work is considered any activity that generates or has the potential to generate, heat, sparks, open flame, or explosion (for example, hot riveting, welding, burning, abrasive blasting, brazing, cutting, grinding, powder-actuated tools, soldering). Grinding, drilling, abrasive blasting, or similar spark-producing operations are also considered hot work except when such operations are isolated physically from any atmosphere containing more than 10% of the LEL of a flammable or combustible substance. (10-2.m)

n. Hot Work Permit. Written authorization to perform hot work operations. (10-2.n)

o. Oxyfuel Gas Cutting. An oxygen cutting process that uses heat from an oxyfuel gas flame. (10-2.o)

p. Oxyfuel Gas Welding. A welding process that joins work pieces by heating them with an oxyfuel gas flame. (10-2.p)

q. Qualified Person (QP). See paragraphs 1-2 or 2-2, as applicable. (10-2.q)

10-3. Personnel Required Qualification/Training.

a. General. Train welders, cutters, and their supervisors in the safe operation of their equipment, safe welding/cutting practices, proper respirator use, and fire protection procedures to follow when welding/cutting. See chapter 5 for respiratory protection and chapter 9 for fire protection. (10-3.a)

b. Welders. Welders must be designated in writing for the job functions they are expected to perform. Proof of qualification must be attached to the designation. (10-3.b)

c. Structural Welding. Persons performing structural welding or inspections on critical items must be trained and certified according to AWS standards (for example, Certified Senior Welding Inspector (CWSI), Certified Welding Inspector (CWI), or equivalent inspector). (10-3.c)

d. Hot Tap. Only competent personnel may hot tap, weld, or cut on active flammable gas, liquid transmission, or distribution pipeline. (10-3.d)

10-4. Roles and Responsibilities.

a. Critical Weld Inspectors. CWSI, CWI, or equivalent inspector must inspect all welds on critical items. (10-4.a)

b. Competent Person (CP). A CP must evaluate hazards to determine what controls are needed for welding, cutting, and heating operations that do not involve conditions or materials described in this chapter. (10-4.b)

10-5. Inspection Requirements.

Inspect all welding equipment before each use to ensure that all required safety devices and ancillary equipment are in place and properly functioning. Remove defective equipment from service, replace or repair it, and re-inspect it before placing back in service. Inspect these and similar items:

a. Torches. (10-5.a)

b. Cables. (10-5.b)

- c. Shut-off valves. (10-5.c)
- d. Couplings. (10-5.d)
- e. Tips. (10-5.e)

10-6. Activity Hazard Analysis (AHA) Requirements.

Develop AHAs according to paragraphs 1-6 or 2-6, as applicable, for all activities involving hot work. Include the following in the AHA:

- a. Type of metals being used. (10-6.a)
- b. Type of welding process. (10-6.b)
- c. Type of extinguishing method for each operation or process. (10-6.c)
- d. Identify the CP for welding and fire watch. Employer will determine how long a fire watch is required to stay in place, but it must be a minimum of thirty (30) minutes after the exposure has ended and documented in the AHA. (See chapter 9) (10-6.d)
- e. PPE required (see chapter 5). (10-6.e)

10-7. Minimum Plan Requirements.

A written Housekeeping Plan is required for all welding, cutting, brazing, or heating operations that involve toxic materials. Develop the plan according to chapter 35 of this manual, to include the following:

- a. Detailed description of the activity being performed, to include the frequency, type, and volume of hot work activities. (10-7.a)
- b. Description of anticipated hazards or concerns and the control measures that will be implemented to control to an acceptable level, to include routine maintenance and housekeeping procedures and schedule. For example, frequency that all surfaces need to be regularly high efficiency particulate air vacuumed and wet wiped so that they are free of contamination. (10-7.b)
- c. Assignment of personnel and their roles and responsibilities. Include necessary information/documentation to support qualification/training of such persons. (See para 10-3) (10-7.c)
- d. Inspection and oversight methods to ensure adherence to the plan. (10-7.d)

10-8. General Requirements.

a. General. (10-8.a)

(1) All welding and cutting equipment and operations must be according to standards and recommended practices of ANSI Z49.1.

(2) Before heat is applied to a drum, container, or hollow structure, a vent or opening must be provided for the release of any built-up pressure generated during the application of heat. Do not use heat or spark producing tools to create or provide venting.

(3) Keep cable, hoses, and other equipment clear of passageways, ladders, and stairways.

b. Electrical and Pressurized System Requirements. Maintain and use welding cylinders according to paragraph 10-8.g. (10-8.b)

c. Personal Protective Measures. A CP must evaluate hazards to determine what controls are needed for welding, cutting, and heating operations that do not involve conditions or materials described in this chapter. (10-8.c)

(1) Eye and Face Protection. Protect the eyes and face of welders and those exposed to such tasks from UV and infrared radiation and flying objects during welding, grinding, and chipping operations. (See chapter 5)

(a) Protect personnel performing or exposed to work that produces UV, blue, or infrared light from these hazards according to the following requirements:

(a-1) Select shaded lenses based on the type of equipment and work (see chapter 5).

(a-2) Protective helmets must have non-reflective surfaces and be free of cracks or openings.

(a-3) Do not use lenses that are cracked or pitted.

(a-4) All filter lenses must meet ANSI/ISEA Z87.1 requirements.

(a-5) Welding helmets and ANSI Z87.1 rated safety glasses with top and side protection must always be used.

(b) Do not use electronic-shading welding helmets for welding processes requiring a higher shade rating than the helmet can give. Most auto-darkening helmets are not suited for welding processes requiring a filter shade of 14 or higher.

(2) Naturally or mechanically vent all welding, cutting, and heating operations so that personnel exposures to hazardous concentrations of airborne contaminants are within acceptable limits. Provide local exhaust ventilation whenever welding, cutting, or heating is performed in a confined space. (See chapter 6)

(3) Protect other persons exposed to the same atmosphere as welders or cutters in the same manner as welders or cutters.

(4) Arc and Gas Cutting. Employ local mechanical exhaust ventilation or other means to adequately remove the fumes generated during oxygen cutting that involves either an iron powder or chemical flux, gas-shielded arc cutting, or plasma cutting.

d. Fire Protection. (10-8.d)

(1) Suitable fire extinguishing equipment of sufficient capacity must be provided in the immediate vicinity of welding or cutting operations and maintained in a state of constant readiness for immediate use.

(2) Hot work permits are required on federal installations when hot work operations are performed, unless otherwise indicated by the USACE supervisor/KO or COR (see chapter 9).

(3) Before conducting welding or cutting operations, survey the area to ensure it is free of the following hazards:

(a) Combustible materials located close to the operation (for example, within 35 feet (10.7 m)).

(b) The presence or possible generation of potentially explosive atmospheres (for example, flammable gases, vapors, liquids, dusts).

(c) The presence or nature of an oxygen-enriched atmosphere.

(4) Hierarchy of fire control. Objects to be welded, cut, or heated must:

(a) Move object(s) to a location free of dangerous combustibles.

(b) If the work cannot be moved, take all moveable fire hazards in the vicinity to a safe place (for example, moved at least 35 feet (10.7 m) horizontally from the welding or cutting area) or protect the combustible material and construction from the heat, sparks, and slag of welding.

(c) When welding or cutting must be done in a location where combustible or flammable materials are located, the USACE supervisor/KO or COR must inspect the operations and authorize an exception before the work may begin. A fire watch must stand with readily available fire extinguisher equipment and be available to sound an

alarm in the event of a fire. Employer will determine how long a fire watch is required to stay in place, but it must be a minimum of thirty (30) minutes after the exposure has ended and documented in the AHA. (See chapter 9)

(5) When an operation is such that normal fire prevention precautions are not sufficient, assign additional fire watch personnel to guard against fire and instruct them in anticipated fire hazards and use of the firefighting equipment (see chapter 9).

(6) When welding or cutting is to be done over combustible flooring, protect the flooring with fire-resistant shielding covered with damp sand, or kept wet. Where flooring is wet or damp, protect personnel operating arc welding or cutting equipment from potential shock hazards.

(7) Install noncombustible barriers below welding or burning operations in a shaft or raise.

(8) Tightly cover openings or cracks in walls, floors, or ducts within 35 feet (10.7 m) of the site of welding or cutting operations to prevent the passage of sparks to adjacent areas.

(9) Where welding or cutting is to be done near walls, partitions, ceilings, or roofs of combustible construction, use fire resistant guards to prevent ignition.

(10) Where welding or cutting is to be done on a metal wall, partition, ceiling, or roof, take precautions to prevent ignition due to heat conduction or radiation of combustibles on the other side.

(11) Do not weld or cut on a metal partition, wall, ceiling, or roof with a combustible covering, nor on walls or partitions of combustible sandwich-type panel construction.

(12) Before welding or cutting drums, tanks, or other containers and equipment that have contained HAZMAT, thoroughly clean the containers according to NFPA 326 and ANSI/AWS F4.1.

(13) When welding or cutting is to be conducted near a sprinkler head, use a wet cloth or equivalent protection to cover the sprinkler head and then remove the cloth at the completion of the welding or cutting operation.

(14) When welding or cutting in areas protected by fire detection and suppression systems, take precautions to avoid accidental initiation of these systems.

e. Welding and Cutting Hazardous Materials (HAZMAT). (10-8.e)

(1) Perform welding, cutting, and heating operations on pipelines according to 49 CFR 192.

(2) Test all surfaces covered by a preservative coating whose flammability is not known to determine its flammability before starting to weld, cut, or heat them. Preservative coatings are considered highly flammable when scrapings burn with extreme rapidity.

(a) Remove preservative coatings a sufficient distance from the area to be heated to ensure any temperature increase of the un-stripped metal will not result in visually observable decomposition or degradation of the coatings. Artificial cooling of the metal surrounding the heated area may be used to limit the area to be stripped.

(b) When welding, cutting, or heating toxic surface coatings (for example, paints, preservatives, surface stripping chemicals) in enclosed spaces, strip all surfaces covered with the coatings a distance of at least 4 inches (10.2 cm) from the area of heat application or use airline respirators as deemed necessary by a CP assessment and according to chapter 6.

(3) Materials of toxic significance. Perform welding, cutting, or heating operations that involve or generate any of the toxic substances listed below according to the following requirements: antimony, arsenic, barium, beryllium, cadmium, chromium, chromium (VI), cobalt, copper, lead, manganese, mercury, nickel, ozone, selenium, silver, or vanadium.

(a) Whenever these materials are encountered in confined space, use intrinsically safe local exhaust ventilation and PPE.

(b) Whenever these materials, except beryllium or chromium (VI), are encountered in indoor operations, use, and maintain local mechanical exhaust ventilation systems that are sufficient to reduce and maintain personal exposures to within acceptable limits according to the manufacturer's instructions. Ensure that replacement filters are from the same manufacturer and are the correct filter for the exhaust system. When either beryllium or chromium (VI) is encountered in indoor operations, use approved local mechanical exhaust ventilation systems and personal respiratory protection. (See chapter 6)

(b-1) In areas where only welding is conducted, use a general exhaust system ventilation rate of at least 2,000 cubic feet per minute (CFM) (0.9 m³/s) per welder in open welding areas.

(b-2) Local exhaust ventilation must have a capture velocity of 100 fpm (0.5 m/s), as measured from the farthest distance from the work, and a duct transport velocity of at least 1,000 fpm (5.1 m/s). Local exhaust ventilation systems that filter and return the air back into the work environment are allowed for welding if the work is not located in a confined space or does not involve beryllium or chromium and if the provisions of chapter 6 are followed.

(c) Whenever these materials, except beryllium or chromium (VI), are encountered in outdoor operations, and local mechanical exhaust ventilation systems sufficient to reduce and maintain personal exposures to within acceptable limits are not provided, appropriate respiratory protective equipment must be used (see chapter 6).

(d) Whenever beryllium or chromium (VI) are encountered in outdoor operations, base the justification for and the implementation of engineering and work practice controls and respiratory protection on the results of an initial worker exposure assessment and an exposure determination (see para 10-8.i and chapter 6).

(e) Workers may be exposed to hazardous concentrations of chromium (VI) while welding, cutting, or performing hot work on stainless steel, high chrome alloys or chrome coated metal, or during the application and removal of chromate-containing paints, and other surface coatings (see chapter 6).

(f) When working with materials of toxic significance, workers must remove outer clothing, vacuum off, and wash before taking a break, drinking, smoking, or leaving for the day.

(4) Perform welding, cutting, or heating operations that involve or generate fluorine or zinc compounds according to the following:

(a) In confined spaces, use local mechanical exhaust ventilation and personal respiratory protection sufficient to maintain exposures within acceptable limits (see chapter 6).

(b) In open spaces, perform sampling and testing according to the procedures in chapter 6 to determine concentrations of fluorides or zinc compounds and the need for local exhaust ventilation and personal respiratory protection sufficient to maintain exposures within acceptable limits.

f. Critical Items. (10-8.f)

(1) All structural welding performed on critical items (for example, scaffolding, shoring, forms, ladders, piling), as well as other critical items as determined by QP, must only be performed by certified welders (see para 10-3.c).

(2) Welds on critical items must be inspected by either a current CSWI, a CWI, or equivalent welding inspector trained to AWS standards (see paras 10-3.c and 10-4.a).

g. Oxyfuel Gas Welding and Cutting. (10-8.g)

(1) Oxyfuel gas welding and cutting equipment must be approved by NRTL.

(2) Oxygen Cylinders and Apparatuses.

(a) Keep oxygen cylinders and apparatus free from oil, grease, and other flammable or explosive substances. Do not handle them with oily hands or gloves.

(b) Do not use oxygen cylinders and apparatus interchangeably with any other gas.

(c) Do not place oxyfuel cylinders in a confined space with the workers.

(3) Hose and Hose Connections.

(a) Fuel gas hose and oxygen hose must be readily distinguishable from each other.

(b) Oxygen and fuel gas hoses are not interchangeable. Do not use a single hose having more than one gas passage.

(c) Do not use hose couplings of the type that can be unlocked or disconnected without a rotary motion.

(d) Test hoses that have been subjected to flashback or that shows evidence of severe wear or damage to twice the normal pressure to which it is subjected. In no case test with less than 300 psi (2068.4 kPa) gauge. Do not use damaged hose and hose connectors, or hose and hose connectors in questionable condition.

(e) When parallel runs of oxygen and fuel gas hose are taped together, not more than 4 inches out of every 12 inches (10.2 cm out of every 30.4 cm) may be covered by tape.

(f) Properly ventilate all boxes used for the storage of gas hoses and all enclosed spaces containing gas hoses.

(g) Clamp or otherwise securely fasten hose connections in a manner that will withstand, without leakage, twice the pressure to which they are normally subjected in service, but not less than 300 psi (2,068 kPa) gauge.

(4) Torches.

(a) Inspect torches before each use for leaking shutoff valves, hose couplings, tip connections, and damaged torch tips. Do not use defective torches.

(b) Hoses must be purged individually before lighting the torch for the first time each day. Do not purge hoses into confined spaces or near ignition sources.

(c) Clean clogged torch tip openings with suitable cleaning wires, drills, or other devices designed for such purposes.

(d) Light torches with friction lighters or other approved devices; not by matches or from hot work.

(e) Close torch valves and shut off the gas supply whenever work is suspended.

(f) Remove the torch and hose from confined spaces whenever work is suspended.

(5) Protective Equipment.

(a) Unless indicated otherwise by the manufacturer's instructions, install a reverse-flow check valve and a flash arrestor in the hose at each torch when using oxyfuel gas or other oxygen-fuel gas welding and cutting systems that use a cylinder regulator-hose-torch.

(b) When oxygen-fuel gas systems are manifolded together, perform according to NFPA 51.

(6) Do not connect multiple sets of oxyacetylene hoses to a single regulator on a single set of oxyacetylene tanks unless a commercially available fitting that complies with CGA standards and is listed by a NRTL is installed. Install the fitting in the output side of the regulator and include a built-in shut-off valve and reverse-flow check valve on each branch.

(7) Do not adjust acetylene regulators to permit a discharge greater than 15 psi (103.4 kPa) gauge.

h. Arc Welding and Cutting. Install, maintain, and operate all electric welding apparatuses according to the NEC. (10-8.h)

(1) Manual Electrode Holders.

(a) Use only manual electrode holders specifically designed for arc welding and cutting of a capacity capable of safely handling the maximum rated current required by the electrodes.

(b) Fully insulate the current carrying parts passing through the gripped portion of the holder and the outer surfaces of the jaws of the holder against the maximum voltage encountered to ground.

(2) Welding Cables and Connectors.

(a) Cables must be completely insulated, flexible, capable of handling the maximum current requirements of the work in progress, and in good repair. Do not use damaged or defective cables.

(b) Inspect welding cables for wear or damage before each use. Replace or repair cables with damaged insulation or connectors to achieve the same mechanical strength, insulating quality, electrical conductivity, and water tightness of the original cable. Do not use cables containing splices or repaired insulation within a minimum distance of 10 feet (3 m) from the end of the cable to which the electrode holder is connected.

(c) Where it becomes necessary to connect or splice lengths of cable together, use insulated connectors of a capacity at least equivalent to that of the cable. When connecting with cable lugs, securely fasten them together to give good electrical contact and completely cover the exposed metal parts of the lugs. When connecting or splicing lengths of cable together, use methods specifically intended for that purpose and adequately insulate the connections for the service conditions.

(3) Grounding. See chapter 11.

(a) Ground the frames of arc welding and cutting machines either by a third wire in the cable connected to the circuit conductor or by a separate wire that is grounded at the source of the current.

(b) Do not bond either of the welding generator terminals to the frame of the welder.

(c) Do not use pipelines containing gases or flammable liquids or conduits carrying electrical conductors for a ground return circuit.

(d) Ground the circuits from welding machines used for other than welding tools.

(4) Do not place welding supply cables near power supply cables or other high-tension wires.

(5) Do not allow welding leads to contact metal parts supporting suspended scaffolds.

(6) Locate the switching equipment for shutting down the welding machine on or near the welding machine.

(7) Shut down the equipment when the leads are unattended.

(8) Shield arc welding and cutting operations by noncombustible or flameproof screens to protect employees and other persons working within 35 feet (10.7 m) from the direct rays of the arc, sparks, molten metal, spatter, and chipped slag.

(a) Select welding curtains that are suitable for the welding process and amperage.

(b) Welding curtains must be fade resistant and flame retardant.

(9) Spread out coiled welding cable before use to avoid overheating and damage to insulation.

i. Gas Metal Arc Welding. (10-8.i)

(1) Keep chlorinated solvents at least 200 feet (61 m) away from the exposed arc.

(2) Dry surfaces prepared with chlorinated solvents before welding is permitted on such surfaces.

(3) Protect those less than 35 feet (10.7 m) from the arc and not protected from the arc by screening with filter lenses. When two or more welders are exposed to each other's arc, each welder must wear filter lens goggles under their welding helmets. Use hand shields to protect the welders against flashes and radiant energy when either the helmet is lifted, or the shield is removed.

(4) Protect welders and other persons who are exposed to radiation by adequately covering the skin to prevent burns and other damage from UV rays. Welding helmets and hand shields must be in good working order and free of defects, cracks, opening, and highly reflective surfaces. Set up screens around welding work area to protect personnel outside of the immediate work zone from being exposed to UV rays.

(5) When gas metal arc welding is performed on stainless steel, chrome alloy steel, or chrome-coated metal, ventilate the area using an approved local exhaust system to protect personnel against dangerous concentrations of nitrogen dioxide and other air contaminants such as chromium (VI). The exhaust system must be capable of reducing and maintaining personal exposures to within permissible limits. If not sufficient, augment the exhaust system ventilation by changing the work practices and engineering controls, such as by using an argon-rich (> 75% argon) shielding gas with gas metal arc welding or flux cored arc welding operations. Wherever engineering and work practice controls are not sufficient to reduce employee exposures below permissible limits, the employer must use them to reduce employee exposures to the lowest levels achievable and must supplement them by using respiratory protection that complies with the requirements of this chapter and chapter 5.

j. Plasma Cutting. Install, maintain, and operate plasma arc cutting equipment according to the NEC and manufacturer's instructions. (10-8.j)

(1) Verify that all consumables (for example, nozzles, electrodes) are installed according to the manufacturer's instructions before each use.

(2) All torches used in plasma cutting must contain a trigger safety device to prevent accidental contact.

k. Thermite Welding. (10-8.k)

(1) Thoroughly dry the mold for a thermite weld and install an acceptable cover recommended by the manufacturer before the charge is ignited to prevent spray back during the thermite welding reaction.

(2) Storage of Thermite Welding Supplies.

(a) Store bulk thermite welding materials in a detached shed or building at least 50 feet (15.2 m) from the welding area.

(b) Maintain bulk storage areas for thermite welding materials dry and locked.

(c) Tightly close storage containers for the starting material immediately after each use.

(3) Do not remove thermite welding molds until sufficient cooling has taken place, as stated in the manufacturer's operating instructions.

(4) Do not smoke in areas where thermite welding material is being used or stored.

10-9. Figures and Tables.

Not Applicable.

10-10. Checklists and Forms.

Not Applicable.

**Chapter 11
Electrical**

11-1. References.

a. ANSI/American Society of Safety Engineers (ASSE) Z490.1, Criteria for Accepted Practices in Safety, Health and Environmental Training (<https://webstore.ansi.org>) (11-1.a)

b. ANSI/NEMA C84.1, Electrical Power Systems and Equipment - Voltage Ratings (60 hertz (Hz)) (2020) (<https://webstore.ansi.org/>) (11-1.b)

c. ASTM F855, Standard Specifications for Temporary Protective Grounds to be Used on De-energized Electric Power Lines and Equipment (2020) (<https://www.astm.org/products-services/standards-and-publications.html>) (11-1.c)

- d. ASTM F2249, Standard Specification for In-Service Test Methods for Temporary Grounding Jumper Assemblies Used on De-Energized Electric Power Lines and Equipment (2020) (<https://www.astm.org/products-services/standards-and-publications.html>) (11-1.d)
- e. British Standards Institution (BSI) British Standard (BS) 7671, Requirements for Electrical Installations (2018) (<https://www.bsigroup.com/en-US/Standards/>) (11-1.e)
- f. IEEE 80, Guide for Safety in AC Substation Grounding (2013) (<https://standards.ieee.org/access-standards/>) (11-1.f)
- g. IEEE 837, Qualifying Permanent Connections Used in Substation Grounding (2014) (<https://standards.ieee.org/access-standards/>) (11-1.g)
- h. IEEE 1048, Guide for Protective Grounding of Power Lines (2016) (<https://standards.ieee.org/access-standards/>) (11-1.h)
- i. IEEE 1246, Guide for Temporary Protective Grounding Systems Used in Substations (2011) (<https://standards.ieee.org/access-standards/>) (11-1.i)
- j. IEEE C2, National Electrical Safety Code (NESC) (2017) (<https://standards.ieee.org/access-standards/>) (11-1.j)
- k. NFPA 70, National Electrical Code (NEC) (2020) (<https://www.nfpa.org/Codes-and-Standards>) (11-1.k)
- l. NFPA 70B, Recommended Practice for Electrical Equipment Maintenance (2020) (<https://www.nfpa.org/Codes-and-Standards>) (11-1.l)
- m. NFPA 70E, Standard for Electrical Safety in the Workplace (2021) (<https://www.nfpa.org/Codes-and-Standards>) (11-1.m)
- n. NFPA 855, Standard for the Installation of Stationary Energy Storage Systems (2020) (<https://www.nfpa.org/Codes-and-Standards>) (11-1.n)
- o. UFC 3-560-01, Operation and Maintenance: Electrical Safety (Change 2- 2019) (<https://www.wbdg.org/ffc/dod/unified-facilities-criteria-ufc>) (11-1.o)
- p. UL 1248, Standard for Engine-Generator Assemblies for Use in Recreational Vehicles (<https://standardscatalog.ul.com/Catalog.aspx>) (11-1.p)
- q. UL 467, Grounding and Bonding Equipment (2013) (<https://standardscatalog.ul.com/Catalog.aspx>) (11-1.q)
- r. UL 508A, Training on Industrial Control Panels (<https://standardscatalog.ul.com/Catalog.aspx>) (11-1.r)

- s. UL 943, Ground-Fault Circuit-Interrupters (2016)
(<https://standardscatalog.ul.com/Catalog.aspx>) (11-1.s)
- t. UL 943C, Special Purpose Ground-Fault Circuit-Interrupters (2012)
(<https://standardscatalog.ul.com/Catalog.aspx>) (11-1.t)
- u. UL 2201, Standard for Carbon Monoxide (CO) Emission Rate of Portable Generators (<https://standardscatalog.ul.com/Catalog.aspx>) (11-1.u)
- v. 29 CFR 1910, Occupational Safety and Health Standards
(<https://www.osha.gov/laws-regs/regulations/standardnumber/1910>) (11-1.v)
- w. 29 CFR 1910.137, Personal Protective Equipment
(<https://www.govinfo.gov/app/details/CFR-2020-title29-vol5/CFR-2020-title29-vol5-sec1910-137>) (11-1.w)
- x. 29 CFR 1910.268, Telecommunications
(<https://www.govinfo.gov/content/pkg/CFR-2019-title29-vol5/pdf/CFR-2019-title29-vol5-sec1910-268.pdf>) (11-1.x)
- y. 29 CFR 1910.269, Electric Power Generation, Transmission, and Distribution
(<https://www.govinfo.gov/content/pkg/CFR-2020-title29-vol5/pdf/CFR-2020-title29-vol5-sec1910-269.pdf>) (11-1.y)
- z. 29 CFR 1910 Subpart S, Electrical (<https://www.govinfo.gov/content/pkg/CFR-2020-title29-vol5/pdf/CFR-2020-title29-vol5-part1910-subpartS.pdf>) (11-1.z)
- aa. 29 CFR 1917.157, Battery Charging and Changing
(<https://www.govinfo.gov/content/pkg/CFR-2020-title29-vol7/pdf/CFR-2020-title29-vol7-sec1917-157.pdf>) (11-1.aa)
- bb. 29 CFR 1926, Safety and Health Regulations for Construction
(<https://www.osha.gov/laws-regs/regulations/standardnumber/1926>) (11-1.bb)
- cc. 29 CFR 1926.56, Illumination (<https://www.govinfo.gov/content/pkg/CFR-2020-title29-vol8/pdf/CFR-2020-title29-vol8-sec1926-56.pdf>) (11-1.cc)
- dd. 29 CFR 1926.1408, Power Line Safety (Up to 350 kV) – Equipment Operations (<https://www.govinfo.gov/content/pkg/CFR-2022-title29-vol8/pdf/CFR-2022-title29-vol8-sec1926-1408.pdf>) (11-1.dd)
- ee. 29 CFR 1926.1410, Power Line Safety (All Voltages) – Equipment Operations Closer Than the Table A Zone (<https://www.govinfo.gov/content/pkg/CFR-2022-title29-vol8/pdf/CFR-2022-title29-vol8-sec1926-1410.pdf>) (11-1.ee)

ff. 29 CFR 1926 Subpart K, Electrical (<https://www.govinfo.gov/content/pkg/CFR-2020-title29-vol8/pdf/CFR-2020-title29-vol8-part1926-subpartK.pdf>) (11-1.ff)

gg. 29 CFR 1926 Subpart V, Electrical Power Transmission and Distribution (<https://www.govinfo.gov/content/pkg/CFR-2020-title29-vol8/pdf/CFR-2020-title29-vol8-part1926-subpartV.pdf>) (11-1.gg)

11-2. Definitions.

a. Arc. A controlled electrical discharge between the electrode and the work piece that is formed and sustained by a gas that has been heated to such a temperature that it can conduct electric current. (11-2.a)

b. Arc Flash. Light and heat produced from an unintended electric arc fault with sufficient electrical energy to cause substantial damage or injury. An arc flash results from either a phase to ground or a phase-to-phase fault caused by such occurrences as accidental contact with electrical systems, buildup of conductive dust, corrosion, dropped tools, or improper work procedures. (11-2.b)

c. Arc Flash Boundary. When an arc flash hazard exists, an approach limit at a distance from a prospective arc source within which a person could receive a second degree burn if an electrical arc flash were to occur. (11-2.c)

d. Arc Flash Hazard. A dangerous condition associated with the possible release of energy caused by an electric arc. An arc flash hazard may exist when energized electrical conductors or circuit parts are exposed or when they are within equipment in a guarded or enclosed condition, provided a person is interacting with the equipment in such a manner that could cause an electric arc. Under normal operating conditions, enclosed energized equipment that has been properly installed and maintained is not likely to pose an arc flash hazard. (11-2.d)

e. Arc Rating. A value of the IE necessary to pass through any given material, or multiple layers of materials, to cause, with 50% probability, breakopen or onset of a second- degree skin burn injury. This value is measured in calories/cm². The necessary arc rating for an article of clothing is determined by performing an arc flash analysis or a risk assessment. Arc rating is reported as the lower value of either the ATPV or the energy of EBT. (11-2.e)

f. Authority Having Jurisdiction (AHJ). A government office, group, or individual designated in writing as responsible for enforcing the requirements of this chapter. (11-2.f)

g. Authorized Individual Hazardous Energy Control (HEC). Someone who meets the criteria for a QP as defined in this manual (see paras 1-2 or 2-2, as applicable), who is designated in writing to request, receive, implement, and remove hazardous energy isolation procedures. (11-2.g)

h. Barricade. A physical obstruction (for example, tape, screens, cones), intended to warn of and limit access to a hazardous area. (11-2.h)

i. Barrier. A physical obstruction that is intended to prevent contact with energized lines or equipment. (11-2.i)

j. Battery (Primary Lithium Metal). A single cell or multi-cell battery that contains lithium metal and is not designed to be recharged. Typically, they are metal encased in cylindrical, prismatic, or coin shaped cells. (11-2.j)

k. Battery (Secondary Lithium Metal). A single cell or multi-cell battery that contains lithium salt in a liquid or polymer-based electrolyte that is designed to be recharged and may or may not contain an integrated electrical controller. Typically, they are encased in cylindrical, prismatic, or polymer pouch soft cases. Laptop, cell phone, drone, cordless tool batteries all fall in this category. (11-2.k)

l. Bond. An electrical connection from one conductive element to another to minimize potential differences or providing suitable conductivity for fault current or for mitigation of leakage current and electrolytic action. (11-2.l)

m. Bonding. The permanent joining of metallic parts to form an electrically conductive path that will ensure electrical continuity and capacity to safely conduct any current likely to be imposed. (11-2.m)

n. Bonding Jumper. A reliable conductor to ensure the required electrical conductivity between metal parts required to be electrically connected. (11-2.n)

o. Bracket Grounding. A protective grounding method, typically used with electric power transmission and distribution activities, which involves installing grounds at two locations, one on each side of the work location, typically some distance apart and away from the work location. Bracket grounding application requires detailed engineering analysis and must be based on an evaluation of the potential hazards to the workers, work site conditions, type of construction, and the nature of the work to be done. (11-2.o)

p. Cable. A conductor with insulation, or a stranded conductor with or without insulation and other coverings (for example, single-conductor cable), or a combination of conductors insulated from one another (for example, multiple-conductor cable). (11-2.p)

q. Distribution Lines and Equipment. Electric lines and equipment with operating voltages from 4kilovolt (KV) to 46KV. (11-2.q)

r. Effectively Grounded. Intentionally connected to earth through a ground connection or connections of sufficiently low impedance and having sufficient current-

carrying capacity to prevent the buildup of voltages which may result in undue hazard to connected equipment or to people. (11-2.r)

s. Electrician Master/Journeyman. An industry term showing a level of competency and training that is required to safely perform electrical work according to national or state standards. (11-2.s)

t. Energized. Electrically connected to, or is, a source of voltage. (11-2.t)

u. Engineering Supervision. An industry term derived from NFPA 70 and NESC indicating oversight, approval, or stamped approval by a licensed professional electrical engineer and synonymously used with the following terms: engineering evaluation, engineering judgement, engineering analysis, qualified engineering study, and engineering supervision. (11-2.u)

v. Generator, Mobile. Mobile describes equipment, such as vehicle-mounted generators, that are capable of being moved on wheels or rollers. (11-2.v)

w. Generator, Portable. Portable describes equipment that is easily carried by personnel from one location to another. (11-2.w)

x. Ground. As a noun, the conductive body, usually earth, to which an electric potential is referenced or an incidental or accidental conductive connection between an electric circuit or equipment and a reference ground. As a verb, the connecting or establishing of an intentional or accidental connection between an electric circuit or equipment and a reference ground. (11-2.x)

y. Grounded. Connected to earth or to some conducting body that serves in place of the earth. (11-2.y)

z. Grounded Conductor. A system or circuit conductor that is intentionally grounded. (11-2.z)

aa. Grounded System. A system of conductors in which at least one conductor or point (usually the middle wire or neutral point of a transformer or generator windings) is intentionally grounded, either solidly or through a current limiting device (not a current-interrupting device). (11-2.aa)

bb. Ground-Fault Circuit-Interrupter (GFCI). A device used to interrupt the electric circuit to the load when a fault current to ground exceeds some predetermined value that is less than that required to operate the over current protection device of the supply circuit. (11-2.bb)

cc. Grounding Conductor. A conductor used to connect equipment or the grounded circuit of a wiring system to a grounding electrode or electrodes. (11-2.cc)

dd. Grounding Electrode (Ground Electrode). A conductor embedded in the earth, that is used to maintain conductors connected to it at ground potential and to dissipate current conducted to it into the earth. (11-2.dd)

ee. Induced Current. The generation of a current in a conductor caused by its proximity to a second alternating current (AC) source (for example, a moving direct current (DC) source, such as a motor, or an extraneous voltage source, such as lightning). (11-2.ee)

ff. Isolation. An activity that physically prevents the transmission or release of energy. (11-2.ff)

gg. Limited Approach Boundary. An approach limit at a distance from an exposed energized electrical conductor or circuit part within which a shock hazard exists. (11-2.gg)

hh. Live-Line Bare-Hand Technique (Work). A highly specialized technique (usually used on medium and high-voltage transmission lines) where a QP working from an insulated aerial platform is electrically bonded to an energized line. This technique effectively cancels any electrical potential difference across the worker's body and protects the employee from electric shock. (11-2.hh)

ii. Live-Line Tools. Tools used by QPs to handle energized conductors. The tool insulates the employee from the energized line, allowing the employee to perform the task safely. (Also known as "hot sticks"). (11-2.ii)

jj. Lockout/Tagout (LOTO). See chapter 12. (11-2.jj)

kk. Minimum Approach Distance (MAD). An approach limit at a distance from an exposed energized electrical conductor or circuit part within which there is an increased likelihood of electric shock, due to electrical arc-over combined with inadvertent movement. NFPA 70E calls MAD the Restricted Approach Boundary, this chapter will use the terms interchangeably. (11-2.kk)

ll. Mobile. Equipment that is capable of being moved on wheels or rollers. (11-2.ll)

mm. Portable. Equipment that is easily carried by personnel from one location to another. (11-2.mm)

nn. Qualified Person (QP), Electrical. Someone who meets the criteria for a QP as defined in this manual (see chapters 1 and 2). The term "Qualified Person (QP)", as used in this chapter, refers to "Qualified Person, Electrical." (See para 11-3.b) (11-2.nn)

oo. Restricted Approach Boundary. See MAD. (11-2.oo)

pp. Separately Derived System. A premises wiring system whose power is derived from generator, transformer, or converter winding and has no direct electrical connection, including a solidly connected grounded circuit conductor, to supply conductors originating in another system. (11-2.pp)

qq. Service. The conductors and equipment for delivering electric energy from the serving utility to the wiring system of the premises served. (11-2.qq)

rr. Substation. A high-voltage electric system facility used to switch generators, equipment, and circuits or lines in and out of a system. (11-2.rr)

ss. Temporary Protective Ground (TPG). A personal protection device consisting of a specialized full fault rated cable assembly connected between a de-energized circuit and ground. The device creates a zone of equipotential to limit the voltage to a safe value. (11-2.ss)

tt. Transmission Lines and Equipment. Electric lines and equipment with operating voltages from 69KV to 765KV. (11-2.tt)

uu. Unqualified Person. A person who is not a QP but has received safety training to identify the hazards and reduce the associated risk. (11-2.uu)

vv. Voltage Classes. See ANSI C84.1. (11-2.vv)

(1) Low Voltage. Nominal system voltages of 1000 volts or less.

(2) Medium Voltage. Nominal system voltages greater than 1000 volts and less than 100 kV.

(3) High Voltage. Nominal system voltages equal to or greater than 100 kV and equal to or less than 230 kV.

(4) Extra-High Voltage. Nominal system voltages greater than 230 kV but less than 1000 kV.

ww. Working Distance. The distance between a person's face and chest area and a prospective arc source. (11-2.ww)

xx. Working On. Activities which involve intentional contact with energized electrical conductors or circuit parts with tools or body parts regardless of the PPE a person is wearing which are not in an electrically safe work condition (ESWC). This includes the process of establishing and verifying an ESWC, troubleshooting, manipulation of cables, or performing any repairs/alterations. (11-2.xx)

11-3. Personnel Required Qualification/Training.

a. Electrical Safety Training. All employees exposed to electrical hazards, to include QPs and Unqualified Persons, must be trained to identify and understand the hazards associated with electrical energy, to include possible injury. Training must include safety-related work practices and procedural requirements, as necessary, to provide protection from the electrical hazards associated with their respective job or task assignments. (11-3.a)

(1) Training must be provided by an electrically qualified source to the level of work being performed.

(2) Training may be an interactive classroom (virtual or live), on-the-job, or a combination of the two.

(3) Supervisors must identify the risks to each employee and determine the type and extent of the training.

b. Qualified Persons (QPs), Electrical. QPs must demonstrate the skills and knowledge related to the construction, operation, and maintenance of electrical equipment and installations, and receive relevant safety training to recognize, avoid, and control associated hazards that might be present with respect to that equipment, the work method, and job or task assignments. (11-3.b)

Note. A person can be considered qualified with respect to certain equipment and tasks, but still be unqualified for others.

(1) All QPs must be trained, at a minimum, according to NFPA 70E requirements and procedures.

(2) QPs that install and/or remove electric conductors, equipment, or raceways, or manipulate cables must have verifiable credentials and be familiar with applicable code and electrical safety requirements. Verifiable credentials consist of national, state, or local certifications or licenses that a Master or Journeyman Electrician may hold, or for USACE employees, USACE-sponsored local training programs (for example, hydropower training program, navigation training program) depending on the work being performed. Such QPs must be trained to the level of duties as assigned. All training programs must be approved by the AHJ and be properly documented. All credentials must be submitted to the USACE supervisor for approval or to the KO or COR for acceptance.

(3) Exception to paragraph 11-3(b)(2). In work locations where the state, host nation, province, territory, commonwealth, or tribal sovereign nation does not require licensing for QPs, it is permissible to make an exception to the requirement for documented and validated licensing and apply the local licensing laws over the work location provided the following conditions are met:

(a) The contract employer submits the local laws governing licensing to the USACE supervisor for approval or for the KO or COR for acceptance.

(b) The USACE supervisor/KO or COR submits the documentation to the AHJ to evaluate the local laws as being sufficient to ensure proper training and/or oversight and worker safety.

(c) If at any time, the AHJ determines that the employees are not sufficiently trained in electrical work or safety, the AHJ will notify the USACE supervisor/KO or COR. After the employee has received the proper training, the AHJ will reevaluate before the person may continue to work.

(d) The AHJ provides evaluation (that is, approval or disapproval) documentation to the USACE supervisor/KO or COR.

(e) The exception for electrical licensing does not preclude the requirement for emergency response training (see para 11-3.d).

(4) All QPs must be trained and be competent in the proper selection and use of the special precautionary techniques, PPE, insulating and shielding materials, and insulated tools and test equipment for working on or near exposed energized parts of electric equipment (see chapter 5). The training must include instruction on selecting appropriate test instruments and the limitations of each test instrument that might be used. QPs must demonstrate how to use a device to verify the absence of voltage, including interpreting indication provided by the device.

(5) QPs that perform work that involves exposure to electrical hazards with electric power generation, transmission, and/or distribution lines and equipment must be trained according to 29 CFR 1910.269 , 29 CFR 1926 Subpart V, and NESC.

(6) QPs that perform work within the limited approach boundary must, at a minimum, also be trained on the following:

(a) The skills and techniques necessary to distinguish exposed energized live parts from other parts of electrical equipment.

(b) The skills and techniques necessary to determine the nominal voltage of exposed live parts.

(c) Approach distances specified for personnel in tables 11-1, 11-2, 11-3 and the corresponding voltages to which the QP will be exposed.

(d) Minimum clearances specified for vehicular and mechanical equipment in table 11-4.

(e) Decision making process necessary to perform job safety planning (for example, to assist in preparing the APP and AHA), identify electrical hazards, assess the associated risk, and select the appropriate risk control methods form the hierarchy of controls, including PPE (see para 11-7.a(9)).

(7) An individual who is undergoing on-the-job training for the purpose of obtaining the skills and knowledge necessary to be considered a QP may be considered as a QP for the performance of those specific duties under the following conditions:

(a) They demonstrate an ability to safely perform specific duties at their achieved level of training.

(b) They are under the direct supervision of a QP.

c. Unqualified Persons. Unqualified Persons who may be exposed to shock and arc flash hazards must be trained and be familiar with any electrical safety-related practices necessary for their safety. (11-3.c)

d. Emergency Procedures. All employees exposed to shock hazards and any employees responsible for taking action in the case of emergency must be trained in first aid response (for example, CPR, AED) according to chapter 3, NFPA 70E, and annually in the methods of release for victims who contact exposed energized electrical conductors or circuit parts. (11-3.d)

Note. In situations where exception is made for QP licensing (see para 11-3.b(3)), such persons must still receive the training as required by this paragraph.

e. Lithium Batteries. Employees responsible for storage and handling of new, used, and damaged lithium-based batteries must be trained in the following: (11-3.e)

(1) Proper fire prevention methods to be used for primary and secondary lithium-based batteries.

(2) How to recognize the differences between primary and secondary batteries.

(3) Eye protection required during fire mitigation.

(4) Shipping and handling protocols.

(5) Safe storage and handling practices.

(6) How to identify damaged cells or cells that are beginning to exhibit thermal runaway.

f. Retraining. Provide retraining in safety-related work practices and changes to applicable standards at least every three years, or when any of the following conditions exists: (11-3.f)

(1) When there are changes to applicable standards.

(2) The AHJ, supervision, or annual inspection determine the employee is not following the safety-related work practices.

(3) New technology, new types of equipment, or changes in procedures necessitate the use of safety-related work practices differ from those that the employee would normally use.

(4) For tasks that are performed less than once per year, retraining must be performed before performing the work.

(5) When safety-related work practices are not normally used by the employee during regular job duties, perform retraining before performing the work.

(6) A change in the employee's job assignment.

g. Training Documentation. All electrical safety training must be documented according to OSHA and ANSI Z490.1, to include an outline of the training, each employee's name, and the dates of the training. Training documentation must be provided when the employee demonstrates proficiency, be retained for the duration of employment, and be verifiable. (11-3.g)

11-4. Roles and Responsibilities.

a. Qualified Persons (QPs), Electrical. QPs are responsible for the following: (11-4.a)

(1) Performing inspections according to paragraph 11-5.

(2) Assist in developing AHAs according to paragraph 11-6.

(3) Complying with the safety-related work practices and procedures provided by their employer.

(4) Ascertain by inquiry, direct observation, and by instruments whether any part of an exposed or concealed electric power circuit is located where it could bring any person, tool, or machine into physical or electrical contact with it prior to starting the work.

(5) When Unqualified Persons are working near a limited approach boundary, the QP in charge of the work area must inform them of the existing electrical hazards.

(6) The QP must work with supervision to determine the number of workers required to perform the job safely and identify the number of workers in the corresponding AHA. Work must be performed with enough workers to provide a safe working environment (see para 11-8.e(3)). The Journeyman/Apprentice ratio must be according to state, local, and host nation requirements applicable to where the work is being performed.

(7) Only QPs are authorized to perform the following:

(a) Establish ESWCs.

(b) Work on electrical conductors or circuit parts that have not been put into an ESWC.

(c) Interact with equipment where conductors or circuit parts are not exposed, but an increased likelihood of injury from an exposure to an arc flash hazard exists (see NFPA 70E table 130.5(c)).

(d) Install and/or remove electric conductors, equipment, or raceways, or manipulate cables. Such QPs must have verifiable credentials. (See para 11-3.b)

(e) Place and remove TPG.

(f) Work on power generation, transmission, and distribution lines and equipment.

(g) Operate aerial lift equipment within the minimum clearances (see table 11-4). provided the non-insulated equipment and grounded portions of the lift remain outside of the clearances listed in table 11-3.

b. Unqualified Persons. Unqualified Persons may assist QPs with electrical-related tasks provided they are properly trained in safety awareness and escorted and supervised by the QP. They must follow the established safety-related work practices and procedures. (11-4.b)

(1) Unqualified Persons may not conduct electrical work which exceeds their level of specific training received.

(2) An Unqualified Person may be qualified for one type of work, but unqualified for another based on the training received.

(3) Unqualified Persons may cross the limited approach boundary to assist the QP only after they are informed of the additional hazards and don the appropriate PPE. The Unqualified Person must always be escorted by the QP.

(4) Unqualified Persons may cross the arc flash boundary only if they are wearing the appropriate PPE and are under the close supervision of a QP.

c. Host Employer. The Host Employer must inform contract employers of the following: (11-4.c)

(1) Known hazards covered by this manual that are related to the contract employer's work and that might not be recognized by the contract employer or its employees.

(2) Information about the employer's installation that the contract employer must know to make the assessments required by this manual.

(3) Report observed contract employer-related violations of this chapter to the KO or COR, which will notify the contractor employer.

(4) If work must be performed on an energized system, then the host employer or system owner must first demonstrate that de-energizing introduces additional or increased hazards (for example, interruption of life support equipment, removal of light for an area) or is infeasible due to equipment design or operational limitations (for example, testing, troubleshooting). (See para 11-8.e(4))

(5) All known hazardous locations within the facility prior to construction activities. Any discrepancies between established hazardous locations and contract requirements will be addressed by the KO or COR.

d. Contract Employer (Contractor). (11-4.d)

(1) The contract employer must ensure employees are instructed in the hazards communicated by the host employer, in addition to the basic training required by paragraph 11-3 of this chapter.

(2) The contract employer must determine, through regular supervision or through inspections conducted on at least an annual basis, that each employee is complying with the safety-related work practices required by this chapter and the safety-related work rules required by the host employer.

(3) The contract employer must advise the host employer of the following:

(a) Any unique hazards presented by the contract employer's work.

(b) Hazards identified during the course of work by the contract employer that were not communicated by the host employer.

(c) The measures the contract employer took to correct any violations reported by the host employer under paragraph 11-4.c and to prevent such violation from recurring in the future.

(4) The contract employer must obtain authorization by host employer prior to entry of energized substations.

e. Authority Having Jurisdiction (AHJ), Electrical. The AHJ is responsible for the following actions: (11-4.e)

(1) Communicate through the USACE supervisor/KO or COR for all necessary coordination with contract employers.

(2) Inspect and evaluate equipment that is not listed by a NRTL, document approval, and label as safe prior to installation and use.

(3) Review and approve, in writing, Energized Electrical Work Permit (EEWP) prior to commencement of work (see para 11-8.e(4)).

(4) Interpret and ensure compliance with applicable electrical standards.

(5) Document all approvals, interpretations, or changes. Route any findings that interact with contracts through the KO or COR for final decision.

(6) Ensure compliance with electrical standards by performing electrical inspections of modifications of existing equipment and new construction, including construction by outside employers (contractors).

(7) Determine and establish which code, standard, or criteria is to be used for approving equipment, material, installation, and/or procedures. In most locations, this will be the decision to use the NEC/NFPA 70, NESC, or a combination of the codes.

(8) Provide interpretation of the requirements of this chapter. Such interpretations and clarifications must not have the effect of waiving or exempting requirements specifically provided for in the criteria.

(9) Determine electrical competency levels of individuals.

(10) Inspect emergency temporary installations for safety prior to energizing.

11-5. Inspection Requirements.

The following list is understood to be commonly found inspection requirements, but is not intended to be all-inclusive:

a. Inspect insulating gloves and arc flash PPE prior to each use. See chapter 5 for all PPE requirements and testing requirements and frequencies. (11-5.a)

b. Inspect insulated tools and equipment prior to each use. Inspect the insulation in addition to other aspects of the tool that may affect its use. (11-5.b)

c. Inspect Assured Equipment Grounding Conductor Program (AEGCP) according to paragraph 11-7.b. (11-5.c)

d. Flexible Cords. Inspect all portable flexible cords or cables (for example, extension cords) before use on each shift. (11-5.d)

e. Test temporary electrical distribution systems for polarity, ground continuity, and ground resistance before initial use and before use after modification. Associated GFCIs will be tested monthly. (11-5.e)

f. Power Transmission and Distribution (construction). Inspect power transmission and distribution according to paragraph 11-8.g. (11-5.f)

g. Lithium Batteries. Visually inspect each secondary lithium-based battery's external casing prior to each use, before storage (excluding new, undamaged packaged cells), and before charging for visible damage, bulges, hissing, leaking, smoking, or increased temperature. (11-5.g)

h. Inspect new or modified equipment to verify it has been installed per applicable codes and standards before being energized. (11-5.h)

11-6. Activity Hazard Analysis (AHA) Requirements.

Develop AHAs according to paragraphs 1-6 or 2-6, as applicable. When work is performed that meets the definition of working on electrical equipment, or for activities near enough to expose employees to any electrical hazard they present, include the following in the AHA:

a. Tasks and the number of people needed to safely complete the work. (11-6.a)

b. Identification of the electrical hazards and boundary distances associated with each task. (11-6.b)

c. A shock risk assessment according to paragraph 11-8.b(1) for tasks involving a shock hazard. (11-6.c)

d. An arc flash risk assessment according to paragraph 11-8.b(2) for tasks involving an arc flash hazard. (11-6.d)

e. HEC (for example, LOTO), clearance, and switching procedures (see chapter 12). (11-6.e)

f. Electrical PPE (see chapter 5). (11-6.f)

g. Health considerations (for example, asbestos, polychlorinated biphenyl). (11-6.g)

- h. Environmental considerations, such as wet locations. (11-6.h)
- i. Use of EEWP, as required. (11-6.i)
- j. Personal insulating and grounding methods. (11-6.j)
- k. Temporary power system sketches and AHJ's acceptance documentation. (11-6.k)
- l. Competent Persons (rescue, QP, first aid/CPR, AED, contact release). (11-6.l)
- m. Emergency procedures when "two-person rule" (see 1910.269) is in effect (see paras 11-3(d) and 11-8.e(3)). (11-6.m)
- n. Restricted access locations (for example, substations, vaults). Following the acceptance of an AHA, the contractor must ensure approval for entering restricted access locations is documented and attached to the AHA daily. (11-6.n)

11-7. Minimum Plan Requirements.

a. An Electrical Safety Plan (ESP) is required when personnel perform work that involves exposure to electrical hazards. The ESP must be developed according to NFPA 70E and when work involves exposure to electrical hazards associated with electric power generation, transformation, transmission, and/or distribution lines and equipment, additional requirements according to 29 CFR 1926.950, 29 CFP 1910.269, and the NESC. UFC 3-560-01 was developed for the DoD and can be used as a resource when developing a new safety plan. The plan must include the following: (11-7.a)

(1) Roles and Responsibilities. Identify QPs while outlining their responsibilities and providing qualifications.

(2) Training. The ESP must include training for qualified and unqualified persons meeting the requirements of paragraph 11-3. The ESP must document the contract employer's sources for the required training and outline course content. Training completion documentation must be kept as part of the ESP.

(3) Emergency Response. Develop rescue plan for work that involves exposure to electrical hazards. Also, in addition to first aid and resuscitation requirements identified in chapter 3 and paragraph 11-3.d, train employees exposed to shock hazards and first responders in methods of safe release. Provide and document annual refresher training on the release methods.

(4) Hazard Awareness. The ESP must educate and provide an awareness of the hazards employees are exposed to while performing electrical work. These may

include, but are not limited to, shock and arc flash. The contract employer must identify any hazards they anticipate encountering while performing their work.

(5) Job Safety Planning. Prior to the performance of any work, the contract employer must develop an AHA and conduct a briefing with the employees performing the work. An AHA must be developed according to the requirements of paragraphs 1-6 and 2-6 for all activities, tasks, or DFOW identified for each major phase of work. AHAs for electrical work must include the additional requirements identified in paragraph 11-6. The AHA must address an EEWP if required. The requirements for the EEWP are documented in paragraph 11-8.e(4).

(6) Principles. The ESP must include the various principles comprising the program. Address all the principles included in Annex E of NFPA 70E, such as: inspecting and evaluating electrical equipment, identifying electrical hazard, and protecting employees from shock, burn, blast, and other hazards due to the working environment. Include additional principles, as appropriate.

(7) Controls. The ESP must include controls that will be implemented to ensure safety. Annex E of NFPA 70E provides a list of controls. Examples from the annex include:

(a) The employer develops programs and procedures, including training, and ensuring the employees apply them.

(b) Employees are to be trained to be qualified for working in an environment influenced by the presence of electrical energy.

(c) Procedures are to be used to identify the electrical hazards and to develop job safety plans to eliminate those hazards or to control the associated risk for those hazards that cannot be eliminated.

(d) Every electrical conductor or circuit part is considered energized until the absence of voltage is verified (see para 11-8.d).

(e) Precautions appropriate to the working environment are to be determined and taken.

(8) Procedures. The ESP must detail procedures used by employees exposed to electrical hazards prior to starting work. Annex E of NFPA 70E provides a list to include qualifications and number of employees to be involved, identification of hazards and assessment of risks of the task, safe work practices to be used, and PPE involved.

(a) Operations Adjacent to Overhead Lines. Standard emergency communication procedures must be established and rehearsed to assure rapid emergency shutdown for all work being conducted on overhead power lines. (See para 11-8.s)

(b) Power Transmission and Distribution. See paragraph 11-8.q for additional information.

(c) Work in Energized Substations. See paragraph 11-8.r for additional information.

(9) Risk Assessment Procedures. When working with electricity, employees must attain the knowledge to be able to identify the hazards, assess the risk presented by the hazard, and implement controls. The program must educate employees on the following Hierarchy of Control Methods:

(a) Elimination.

(b) Substitution.

(c) Engineering Controls.

(d) Awareness.

(e) Administrative Controls.

(f) PPE.

(10) Inspection. The ESP must address the inspection of new or modified equipment to verify it has been installed per applicable codes and standards before being energized.

(11) Condition of Maintenance. An employee must be able to assess the maintenance condition of existing equipment as it may affect the risk of hazard exposure. The ESP must include elements that employees must consider when assessing the condition and determining risk.

(12) Incident Investigation. The ESP must show how the contract employer will identify, investigate, and document incidents. Incidents include “close calls” or “near misses” that do not result in a fatality, injury, damage to health, or damage to equipment.

(13) Auditing. The ESP must be audited to ensure its requirements protect employees and that personnel are following and supporting the program. Program audits must be performed at least every three years. The contract employer must perform annual “field work” audits to verify employee participation in the program. Revise the procedures or training program if audits determine that personnel are not following the program requirements.

(14) Lithium Containing Batteries. The ESP must contain specific paragraph covering lithium-based batteries used or stored on the work site. This paragraph of the

ESP requires specific approval by the AHJ who may require limited group storage or charging rules based on the location; quantity, size, and type of batteries being stored or other unique conditions to the site (see chapter 9). The ESP must contain at a minimum the following:

(a) Inventory all types of primary and secondary lithium-based batteries at each site to include quantity, storage, and charging location, fire prevention methods at each location, hazard labeling, and intended use. The location map must be submitted to the USACE supervisor/KO or COR for transfer to fire protection officials at the site.

(b) A lithium-based battery hazard analysis for storage and charging locations.

(c) Required training for employees for use, handling, inspection, storage, transport, and charging of the types of lithium-based batteries at each site (see para 11-3.e).

(d) Be based on industry standards, manufacturer's recommendations, NFPA fire protection standards for building storage and charging location regulations, and NRTL Standards for storage and/or charging containers.

b. Assured Equipment Grounding Conductor Program (AEGCP). When an AEGCP is used in place of GFCIs for ground-fault protection, the AEGCP must be developed according to 29 CFR 1926.404 (29 CFR 1926 Subpart K) requirements. The AEGCP must be submitted and approved by the USACE supervisor or accepted by the KO or COR and made available upon request by any affected persons (see para 11-8.I.(9)(h)). The AEGCP must consist of the following: (11-7.b)

(1) Identification of the conditions or need for the exemption.

(2) Written procedures for equipment inspections, tests, and test schedule.

(a) Visual Inspections. Visually inspect all cord sets, attachment caps, plugs and receptacles, and any equipment connected by cord and plug before each day's use for external damage and for indication of possible internal damage (for example, deformed or missing pins, damaged insulation). Ensure flexible cords are being inspected and those arriving onsite between tests are identified and tested.

(b) Removing Equipment. Equipment found to be damaged or defective or which fails any of the prescribed inspections or tests must be removed from service until repaired or replaced.

(c) Testing. Perform a continuity test and a terminal connection test on all electrical equipment:

(c-1) Before first use.

(c-2) Before placing back in service following any repairs.

(c-3) Before equipment is used after any incident that can be reasonably suspected to have caused damage (for example, when a cord set is run over).

(c-4) At intervals not to exceed three months, except that cord sets and receptacles that are fixed and not exposed to damage must be tested at intervals not to exceed six months.

Note. A continuity test ensures that the equipment grounding conductor is electrically continuous. A terminal connection test ensures that the equipment grounding conductor is connected to its proper terminal at receptacles and cord plugs. (See 29 CFR 1926.404)

(3) Documentation of results for all cord sets, receptacles that are not part of the permanently wiring of a building or structure, and cord sets and equipment connected by cord and plug used on construction sites. All inspections and tests must be documented to identify all equipment that passed the inspection or test, the date of the inspection or test, and the individual responsible for the inspection.

(4) Designation of one or more CPs (see chapters 1 and 2) to implement and enforce the AEGCP at each site it is implemented.

11-8. General Requirements.

a. General. (11-8.a)

(1) All electrical wiring and equipment must be a type listed by a NRTL for the specific application for which it is to be used. For equipment not listed by a NRTL, the AHJ must determine if use is allowable. The AHJ must inspect, approve, and label safe for use all electrical equipment not a type listed by a NRTL.

Note. Examples of non-NRTL equipment would be IEC rated but not NEMA rated products, “CE” marked equipment covered by Declarations of Conformity to European Union (EU) directives and European Standard (EN) standards, or USACE constructed control panels that would fall under the UL-508A listing that are used only at the facility where they are constructed.

(a) Contract employers must verify that the equipment they are using is properly listed.

(b) Rental equipment must be listed by a NRTL. Rental equipment not listed by a NRTL must be approved by the AHJ prior to initial use.

(2) Excavation and Trenching. See chapter 25 for utility verification and work activity procedures.

(3) All electrical work must comply with applicable NESC (for example, NESC, NFPA70, NFPA 70E, NFPA 70B), OSHA, and USCG requirements (see paras 11-3 and 11-4). If the requirements of this chapter differ with the above requirements, the AHJ will determine, approve, and document the basis for which code or standard applies to the work based on the requirements.

Note. When working OCONUS, all electrical work must comply with either the host nation's requirements, NFPA70 (NEC) or IEEE-C2 (NESC), or BSI BS 7671. In general, the host nation requirements will be used in countries with an existing electrical code, NFPA 70 (NEC) or IEEE- C2 (NESC) will be used in countries where 60 Hz power is predominant and the country does not have an established electric code, and BSI BS 7671 will be used in countries where 50 Hz power is predominant and where no electric code exists.

(4) Comply with the design safety standards for electrical systems included in 29 CFR 1910 and 29 CFR 1926 for all work covered by this chapter.

(5) Comply with the design requirements included in the NESC and NFPA70 for all work performed and covered by the scope of these two standards.

(6) Comply with the more stringent design specifications included in contract unless they violate OSHA requirements.

b. Electrical Hazard Risk Assessments. Conduct shock and arc flash risk assessments, at a minimum, to identify safety-related work practices prior to any electrical hazard exposure. Document the results in the AHA. (See para 11-6) (11-8.b)

(1) Shock Risk Assessment. A shock risk assessment is used to identify the shock hazards, estimate the likelihood and severity of an injury occurring, and determine whether additional protective measures (for example, engineering controls, PPE) are necessary. The shock risk assessment must include the following:

(a) Use the shock risk assessment to determine the voltage that personnel might be exposed to, the approach distances, and any PPE or insulated equipment needed to protect against the hazard.

(b) Limited Approach Boundary. The limited approach boundary must be defined in each shock risk assessment (see tables 11-1 and 11-2).

(b-1) When Unqualified Persons are working at or near the limited approach boundary, the QP in charge of the work must identify the electrical hazards and warn them of the boundary.

(b-2) An Unqualified Person must not cross inside the limited approach boundary of energized conductors or circuit parts unless there is a need in which the QP must

instruct them on the hazards present and continuously escort them while inside the boundary.

(c) MAD (Restricted Approach Boundary). The MAD must be defined in the shock risk assessment. The MAD lies inside the limited approach boundary (see table 11-3). A QP must not approach or take a conductive object closer than the MAD unless:

(c-1) The QP is insulated or guarded from energized electrical conductors or circuit parts operating at 50 volts or more. Insulating gloves and sleeves are considered insulation only with regards to the energized parts upon which work is performed; or

(c-2) The energized electrical conductors or circuit parts are insulated from the QP and from any other conductive object at a different potential.

(2) Arc Flash Risk Assessment. An arc flash risk assessment is used to identify the arc flash hazards, estimate the likelihood and severity of an injury occurring, and determine whether additional protective measures (for example, PPE) are necessary.

(a) Use the arc flash risk assessment to determine the appropriate safety-related work practices, the arc flash boundary, the working distance, and any PPE to be used within the arc flash boundary.

(b) Arc Flash PPE. Select arc flash PPE using one of the following methods, but not both:

(b-1) Incident Energy (IE) Analysis. An IE Analysis uses short circuit, coordination, and arc flash studies to determine the IE for a given operating condition at a piece of equipment. The analysis method must account for the overcurrent device characteristics as well as the fault clearing time and condition of maintenance. Use NFPA 70E table 130.5(G) to identify the arc flash PPE when the IE analysis method is used. Unless it is part of the scope of the current contract, the responsibility for the IE Analysis usually lies with the host employer or system owner.

(b-2) Arc Flash PPE Category Method. If an IE Analysis is not performed by the contract employer or provided by the host employer or system owner, use NFPA 70E table 130.7(C)(15)(a) to determine the arc flash PPE category for AC equipment or NFPA 70E table 130.7(C)(15)(b) for DC equipment. The tables include maximum fault currents, maximum clearing times, and minimum working distances for determining the PPE category. When equipment exceeds these ratings, an IE analysis must be performed. When the arc flash PPE category has been determined from the appropriate table, use NFPA 70E table 130.7(C)(15)(c) to identify the PPE appropriate for the task.

Note. Prior to commissioning new equipment, the Category Method must be used if an IE Analysis is not performed. The Category Method cannot be used if the parameters

for use of the tables are not met. All temporary construction power distribution equipment must have the PPE Category indicated prior to initial energization.

(c) Equipment Labeling. Labels must be placed on energized equipment that is likely to require examination, adjustment, servicing, or maintenance while energized. Labels are required to warn of potential shock and arc flash hazards. Unless it is part of the scope of the current contract, the responsibility for labeling usually lies with the host employer or system owner. Labels must include the following:

(c-1) Nominal system voltage.

(c-2) Limits of approach.

(c-3) Arc flash boundary.

(c-4) At least one of the following from c-5 through c-7:

(c-5) Available IE and the working distance or the arc flash PPE category based on NFPA 70E Table 130.7(C)(15)(a) or Table 130.7(C)(15)(b) for the equipment, but not both.

(c-6) Minimum arc rating of clothing.

(c-7) Site-specific level of PPE.

(3) Physical or Mechanical Barriers. Provide suitable temporary barriers or other means to designate arc flash and electrical shock boundaries. Install the barriers no closer than the limited approach boundary or arc flash boundary, whichever is the greater distance. Boundaries must ensure that a workspace cannot be used as a passageway while electrical work is being performed. Barriers must be installed prior to performing work that exposes workers to electrical hazards.

(4) Insulating Tools. All insulating tools used to protect employees from electrical hazards must comply with 29 CFR 1910.137 and chapter 5 of this manual. Properly rated insulating tools must be used when working on energized equipment when there is a risk of the tool contacting another energized conductor or grounded conductive objects.

c. PPE. Personnel working inside the limited approach and/or arc flash boundaries must select the proper shock and arc flash PPE based on the requirements of this chapter and chapter 5. (11-8.c)

(1) Arc flash PPE must cover potentially exposed areas as completely as possible. Shirt and coverall sleeves must be fastened at the wrists, shirts tucked into pants, and shirts, coveralls, and jackets closed at the neck.

(2) All garments, including fall protection harnesses, worn over arc rated protective clothing must also be arc rated.

d. Establishing an Electrically Safe Work Condition (ESWC). All equipment and circuits must be de-energized before work is started unless energized work can be justified. A QP must complete and verify the following to establish electrically safe working conditions: (11-8.d)

(1) Determine all possible sources of electrical supply to the specific equipment using up-to-date drawings, schematics, and labels.

(2) Control all sources of electrical energy to minimize employee exposure to electrical hazards.

(3) Visually verify the disconnecting device is open or circuit breaker is withdrawn whenever possible.

(4) Apply HEC devices (see chapter 12).

(5) Verify each phase conductor or circuit part is de-energized using an adequately rated test instrument (see NFPA 70E).

(6) Where induced voltages are possible, stored electrical energy exists, or if required within this chapter, ground the conductors or circuit parts before touching them.

e. Work Involving Electrical Hazards. (11-8.e)

(1) Energized electrical conductors or circuit parts operating at 50V or more must be placed into an ESWC prior to performing any work if either of the following conditions exist:

(a) An employee is to be within the limited approach boundary (see tables 11-1 and 11-2).

(b) An employee is to interact with equipment where conductors or circuit parts are not exposed but an increased likelihood of an arc flash hazard exists.

(2) Conductive Articles Being Worn. Do not wear conductive jewelry or clothing (for example, wristbands, watch chains, rings, bracelets, necklaces, body jewelry, piercings, metal frame glasses, material with conductive thread) within the MAD or where they present an electrical contact hazard with exposed energized electrical conductors or circuit parts.

(3) Number of Personnel. The nature and hazards of the electrical work dictate the number of personnel required to work safely.

(a) At least two persons must always be in the immediate area when work is being performed on exposed, energized electrical conductors or circuit parts carrying 50V or more. Each person must be able to see and hear the other. This ensures that each person can assist the other in case of an accident. Each person must know the location of, have unobstructed access to, and know how to operate the power cutoff for the work area, how to perform safe contact release, and how to contact emergency personnel.

(b) Exceptions for one person:

(b-1) Work on systems in an ESWC.

(b-2) Routine electrical measurements on energized systems with nominal system voltages of 600 volts AC or 250 volts DC or less using appropriate PPE.

(b-3) Routine circuit switching if the equipment has been properly maintained and site conditions allow for safe performance of work.

(b-4) Routine electrical measurements or switching above 600 volts AC or 250 volts DC using appropriate PPE and live-line tools if the worker is positioned out of reach or possible contact with energized parts.

(b-5) Emergency repair work to safeguard the general public, if previously authorized.

(4) Energized Electrical Work Permit (EEWP). All equipment and circuits must be placed into an ESWC before work is performed on them, unless the work meets the EEWP exemption located under paragraph 11-8.e(5) or the host employer or system owner can show that there are additional hazards or an increased risk from de-energizing. Once it has been determined that equipment must be worked on in an energized condition, an EEWP must be submitted to the USACE supervisor/KO or COR and AHJ for acceptance. Do not perform energized work without prior authorization. All permits must be prepared, signed, and authorized in advance of performing any electrical work. A non-mandatory ENG Form 6277 (Energized Electrical Work Permit) is provided in paragraph 11-10. Other permit formats may be accepted provided they contain the following minimum information:

(a) Description of the circuit and equipment to be worked on and their location.

(b) Description of the work to be performed

(c) Justification for why the work must be performed in an energized condition.

(d) Description of work practices to be followed.

(e) Shock risk assessment: voltage exposure, limits of approach, and PPE.

(f) Arc flash risk assessment: available IE at working distance or arc flash PPE category, arc flash PPE, and arc flash boundary determination.

(g) Means to restrict access of Unqualified Persons in work area.

(h) Evidence of completing the job briefing, including safety, tools, PPE, any other hazards and control.

(i) The USACE supervisor, USACE facility/site manager, and the AHJ are required to sign the EEWP. If the permit is requested by Contract Employer the EEWP will include signatures for SSHO, USACE facility/site manager, KO or COR, and the AHJ.

(5) Exemptions to an EEWP. An EEWP is not required when a QP utilizes safe work practices and PPE while performing the following tasks:

(a) Testing, troubleshooting, or voltage measuring.

(b) Thermography, ultrasound, or visual inspections if the MAD is not crossed.

(c) Access to, and egress from, an area with energized electrical equipment if no electrical work is performed and the MAD is not crossed.

(d) General housekeeping and miscellaneous non-electrical tasks if the MAD is not crossed.

(e) Work within an energized industrial control panel provided all following conditions are met; the circuit being worked on is placed in an ESWC, the voltage levels of any conductor inside the industrial control panel is less than or equal to 300V AC phase to phase or 130V dc, shock hazards presented by energized conductors can be mitigated by avoiding contact, and the work site has documented AHJ approval.

f. Flexible Cords. Use flexible cords according to 29 CFR 1926.405 (29 CFR 1926 Subpart K) and 29 CFR 1910.305 (29 CFR 1910 Subpart S), as applicable. (11-8.f)

(1) Portable flexible cords must contain adequately sized conductors required for the load plus an adequately sized equipment ground conductor. A QP must determine appropriate hard or extra hard usage flexible cord length and size according to NFPA table 400.4. Portable flexible cords used in construction and maintenance on circuits less than 600V must be minimum 14 American Wire Gauge (AWG).

(2) Protect portable flexible cords passing through work areas from damage (for example, foot traffic, vehicles, sharp corners, protections, pinching). Protect flexible cords passing through holes by bushings or fittings.

(3) Portable flexible cords may be used only in continuous lengths without splice or tap. The repair of hard-service cords/cord sets is only permitted if conductors are spliced according to NFPA 70, which requires that cords be spliced by a QP, the insulation is equal to the cable being spliced, and wire connections are soldered, and the following conditions are met:

(a) Maintenance. Hard-service cord and junior hard-service cord No. 14 and larger may be repaired if spliced so that the splice retains the insulation, outer sheath properties, and usage characteristics of the cord being spliced (see 29 CFR 1910.305).

(b) Construction. Hard service flexible cords No. 12 or larger may be repaired if spliced so that the splice retains the insulation, outer sheath properties, and usage characteristics of the cord being spliced (see 29 CFR 1926.405).

(4) Do not use worn or frayed portable flexible cords.

(5) Portable flexible cords must be supported in place at intervals that ensure that they will be protected from physical damage. Support must be in the form of cable ties, straps, or similar- type fittings installed so as not to cause damage. Do not use nails or suspend by bare wire.

g. Fuses. When fuses are installed or removed with one or both terminals energized, use an insulated fuse pulling tool for the rated voltage. (11-8.g)

h. Attachment Plugs and Receptacles. (11-8.h)

(1) When portable electric equipment or flexible cords are used in highly conductive work locations, such as those inundated with water or other conductive liquids, listed equipment must be used.

(2) Attachment plugs for use in work areas must be constructed so that they will endure rough use and must be equipped with a strain relief to prevent strain on the terminal screws.

(3) Physical attachment of plugs into receptacles rated over 240 volts must be made with the circuit de-energized according to chapter 12 unless one of the following conditions are met:

(a) The cord connected load has been switched to the off position, unloading the circuit and the plug or receptacle is de-energized by design with an integral disconnect, before electrical contact is made.

(b) The receptacle is de-energized by local disconnect which is considered under the sole control of the individual attaching the plug.

(c) The receptacle is protected by a residual current device (RCD) set to open at currents not exceeding 30 milliamps and a trip time of 400 milliseconds.

(4) When a NEMA standard configuration exists for a particular voltage, amperage, frequency, or type of current, the NEMA standard plug and receptacle must be used. When NEMA standard configurations do not exist, such as OCONUS, standard plug and receptacle pairs must be rated for the particular voltage configuration, amperage, frequency, type of voltage, and appropriately listed.

i. Clear Spaces. Provide and maintain access to, and egress from, working space around all electrical equipment to permit ready and safe operation and maintenance according to NFPA 70, Spaces About Electrical Equipment. Open equipment doors must not impede access to and egress from the working space. A space of 24" (15" on cranes) must be the minimum distance required when one or more doors are open for access or egress to not be considered impeded. Where required clearance is not feasible (for example, floating plant, vessels), establish procedures to ensure sufficient clearance is maintained for fully opening the door and/or servicing the electrical enclosure so that personnel can escape upon an arc flash event. (11-8.i)

j. Labeling. The following equipment must be labeled or marked as indicated at a minimum. Other labeling or marking requirements and the means and methods of acceptable application and construction of the labels or markings may be required by other paragraphs of this manual or by documents referenced by this manual that are required to be adhered to. (11-8.j)

(1) Mark, label, or arrange all switches, fuses, and automatic circuit breakers for ready identification of the circuits or equipment that they supply.

(2) Mark switchboxes, receptacle boxes, metal cabinets, enclosures around equipment, and temporary power lines to indicate the system voltage.

k. Motors and Controllers. Provide insulating mats or platforms where live parts of motors or controllers operating at over 150V to ground are guarded against accidental contact only by location and where adjustment or other attendance may be necessary during the operation of the apparatus so that the attendant cannot readily touch live parts unless standing on the mats or platforms (see 29 CFR 1926.405). (11-8.k)

l. Grounding and Bonding. Unless otherwise noted in this manual, provide a permanent, continuous, and effective path to ground by grounding and bonding all electrical circuits, equipment, and enclosures according to 29 CFR 1910.304, NFPA 70, and NESC as applicable to the installation. (11-8.l)

(1) Generators.

(a) Portable Generators. The frame of a portable generator is not required to be grounded and may serve as the grounding electrode for a system supplied by the

generator if the generator supplies only equipment mounted on the generator and/or cord-and-plug-connected equipment through receptacles mounted on the generator, and the non-current-carrying metal parts of the equipment and the equipment grounding conductor terminals of the receptacles are bonded to the generator frame.

(b) Mobile/Vehicle-Mounted Generators. The frame of a vehicle is not required to be grounded and may serve as the grounding electrode for a system supplied by a generator located on the vehicle under the following conditions:

(b-1) The frame of the generator is bonded to the vehicle frame.

(b-2) The generator supplies only equipment located on the vehicle or cord-and-plug-connected equipment through receptacles mounted on the vehicle.

(b-3) The non-current-carrying metal parts of equipment and the equipment grounding conductor terminals of the receptacles are bonded to the generator frame.

(b-4) The system complies with provisions of 29 CFR 1910.304.

(c) Portable and vehicle mounted generators used for construction activities must have GFCI protection. The neutral must be bonded to the frame of the generator and/or vehicle (see NFPA 70 445.20(B) and 590.6(A)(3)). Portable GFCIs are allowed for use with generators manufactured or remanufactured prior to January 1, 2011, when used according to paragraphs 11-8.1(1)(a) and (b) of this chapter.

Note. USACE does not recognize the exception in 29 CFR 1926.404(b)(1)(ii) that states "Receptacles on a two-wire, single-phase portable or vehicle-mounted generator rated not more than 5kW, where the circuit conductors of the generator are insulated from the generator frame and all other grounded surfaces, need not be protected with ground-fault circuit interrupters" since it conflicts with current NFPA 70 590.6(A)(3), UL-1248, UL-2201, and was removed from 29 CFR 1910.304(b)(4)(ii)(A) in 2007.

(d) Portable generator installation is allowed as a temporary backup generator in a 'floated neutral' configuration (see NFPA 70). The temporary backup generator must not operate as a separately derived system and must be connected to a transfer switch that bonds the floated neutral to the utility neutral.

(e) The manufacturer must mark the generator indicating if the neutral or grounded conductor is bonded to the frame of the generator. Remark the generator upon field modification of this bonding.

(f) A system conductor (neutral or grounded conductor) that is required to be grounded according to NFPA 70 or 29 CFR 1910.304 must be bonded to the generator frame where the generator is a component of a separately derived system.

(g) For OCONUS portable and vehicle mounted generators that have varying standards differing from this manual, refer to the host nation codes for grounding and bonding of these types of generators.

(2) Portable and semi-portable electric tools and equipment must be grounded by a multi-conductor cord having an identified grounding conductor and a multi-contact polarized plug and receptacle.

(3) Portable and semi-portable electric tools protected by an approved system of double insulation, or equivalent, do not need to be grounded. Double-insulated tools must be distinctly marked and listed by a NRTL.

(4) Ground all floodlights, light plants, and work lights unless they are marked by the manufacturer as double-insulated.

(5) Do not use a grounding terminal or grounding-type device on a receptacle, cord connector, or attachment plug for purposes other than grounding.

(6) Temporary Structures, Equipment, and Fencing. Temporary structures, equipment, and fencing must comply with NFPA 70 Article 545, Relocatable Structure and Article 590, Temporary Installations in addition to the following:

(a) Bond all metal piping systems on portable or temporary structures or equipment with electrical power supplied and water and sewer services attached according to NFPA 70 Article 250 bonding requirements.

(b) Where temporary buildings or structures are placed or constructed under or near overhead electrical power transmission and distribution lines, bond the metallic components on each building or structure together and ground them to earth when any of the following conditions exist:

(b-1) The building or structure is within 100 feet (30.5 m) horizontally of the outside overhead wire.

(b-2) The building or structure has more than 2,000 ft² (185 m²) of metal surface and is located within 100 to 150 feet (30.5 to 45.7 m) horizontally of the outside overhead wire.

(b-3) The building or structure is used to store flammable materials and is within 250 feet (76.2 m) horizontally of the of the outside overhead wire.

(c) Connect temporary buildings, structures, or fencing located near substations and power generation facilities to the facility ground grid mat with engineered products and cables. Consult the facility owners for proper grounding procedures. Near is defined in paragraphs 11-8.1(6)(b) and 11-8.1(6)(d) as applicable. All metallic components on each building or structure should be bonded together by construction of

the building or by addition of bonding jumpers. See paragraph 11-8.1(6)(d) below for fencing bonding.

(d) When temporary metallic or electrically conductive fencing is placed or constructed under or near overhead electrical power transmission and distribution lines, each wire or woven mesh of wires must be bonded together and ground to earth if any of the following conditions exist:

(d-1) It is in the right-of-way of the power lines.

(d-2) It parallels the line within 125 feet (38.1 m) horizontally of the outside overhead wire and is longer than 150 feet (45.7 m).

(d-3) It parallels the line 125 to 250 feet (38.1 to 45.7 m) horizontally from the outside overhead wire and is longer than 6,000 feet (1,829 m).

(7) Grounding Electrode and System Ground Connections.

(a) For 1000V and above (phase to phase) system grounding, use IEEE 837 rated equipment.

(b) For less than 1000V (phase to phase) system grounding, use UL 467 listed equipment.

(c) For all buried or encased grounding, when connecting a system ground grid to grounding buses and terminals, use IEEE 837 rated equipment.

(d) Before energizing electrical systems, properly ground and bond all equipment to the appropriate code. Do not break bonding and grounding connections until systems are deenergized.

(e) Do not use a designated grounding conductor as a current carrying conductor.

(8) Conductors used for temporary bonding or grounding stationary and movable equipment must be of ample size to create an equipotential zone.

(a) When attaching bonding and grounding clamps or clips, a secure and positive metal-to-metal contact must be made.

(b) Attach the ground end first, then the equipment end. Attach or remove the equipment using insulated tools or other suitable devices. When grounding and bonding equipment that contains flammable liquids, reverse this process (that is, attach the equipment end first then ground) to minimize the possibility of sparks near the flammable liquid.

(c) When removing grounds, remove the line or equipment end first using insulated tools or other suitable devices. When removing grounds from equipment with flammable liquids, reverse this process to minimize the possibility of sparks near the flammable liquid.

(9) GFCI Protection for Personnel. All receptacle outlets (125-volt, 15-, 20-, 30-ampere and greater) that provide temporary electrical power during construction, remodeling, maintenance, repair, or demolition must GFCI protection for personnel.

(a) GFCI protection must be provided on all circuits serving portable electric hand tools or semi-portable electric power tools (for example, block/brick saws, table saws, air compressors, welding machines, and drill presses).

(b) GFCI devices used in general construction and for permanent installations must be UL 943 class A rated. Special purpose GFCI devices are allowed under engineering supervision and must be UL 943C class C, D, or E rated. GFCI devices must be tested before initial use and before use after modification.

(c) In lieu of the requirement to install individual circuit protection, temporary power feeders are permitted to be protected by a ground fault protection equipment (GFPE) or RCD installed in a readily accessible location (see NFPA 70).

(d) Protect receptacle outlets that are not part of the permanent wiring of the building or structure with GFCIs using a receptacle outlet with integral GFCI protection, a standard receptacle outlet connected downstream of a receptacle outlet with integral GFCI protection, or receptacles protected by a GFCI-type circuit breaker.

(e) Receptacle outlets that are part of the permanent wiring of the building or structure and are used for temporary electric power, (including portable generators) must use a portable GFCI if the receptacle outlets are not already GFCI protected. The portable GFCI will be as near as practicable to the receptacle outlet.

Note. Exception: In industrial facilities where conditions of maintenance and supervision ensure that only QPs are involved, an AEGCP (see para 11-7.b) is permitted for only those receptacle outlets used to supply equipment that would create a greater hazard if power was interrupted or if their design is not compatible with GFCI protection.

(f) Protect electric tool circuits that are hard-wired directly to an electrical source of power by a GFCI-type circuit breaker.

(g) Install GFCIs according to NFPA 70. Ground electrical circuits of permanent wiring according to NFPA 70.

(h) GFCIs may be sensitive to some equipment (for example, concrete vibrators) or unavailable for the voltage and current rating, or a GFPE/RCD cannot be used. In

these instances, an AEGCP is acceptable in lieu of GFCIs provided it meets the requirements of paragraph 11-7.b.

(10) Temporary Protective Ground (TPG). Place and remove TPGs when grounding lines and equipment is required according to this chapter and OSHA, NFPA 70E, and NESC requirements.

(a) All de-energized conductors and equipment must be tested by a QP using a properly selected voltage meter or detector rated and designed for the system to be measured prior to the application of TPGs.

(b) Place TPGs between the work location and all sources of energy as close as practicable to the work location in such a manner that the employer can demonstrate employees will not be exposed to hazardous differences in electric potential.

(b-1) If work is to be performed at more than one location in a line section, ground and short circuit one location along the line section and ground the conductor to be worked on at each work location. Bracket grounding must be performed under engineering supervision using calculations according to IEEE 1048 and IEEE 1246.

(b-2) Maintain the applicable MAD in table 11-3 from ungrounded conductors at the work location.

(b-3) Where the making of a TPG is impractical, or the conditions resulting from it would be more hazardous than working on the lines or equipment without grounding, the grounds may be omitted and the line or equipment worked as energized.

(c) Grounds may be temporarily removed only when necessary for test purposes. Use extreme caution during the test procedures. Consider all lines or equipment from which grounds have been removed to be energized.

(d) When TPG electrodes are used (for example, for protective grounding during crane operations beneath an energized transmission line), such electrodes must have a resistance to ground low enough to provide protection from the anticipated system fault current. All work must be performed under engineering supervision using calculations according to IEEE 80, IEEE 1048, and IEEE 1246.

(e) TPGs connected to a tower must be made with a tower clamp capable of conducting the expected fault current.

(f) All TPG equipment must meet the following:

(f-1) Equipment must be capable of conducting the maximum fault current that could flow at the point of grounding for the time necessary to clear the fault.

(f-2) Equipment must have an ampacity greater than or equal to that of #2 AWG copper.

(f-3) Equipment must have an impedance low enough so that it does not delay the operation of protective devices in case of accidental energizing of the lines or equipment.

(f-4) Equipment must be tested using the listing agency's recommended testing frequencies and procedures. ASTM listed cable sets must be tested according to ASTM F2249 standards. IEC listed cable sets must be tested using IEC standards.

Note. ASTM F855 is an example of a standard that meets these requirements. If another testing standard is used, it must be evaluated by engineering and the AHJ to determine these requirements are met.

m. Temporary Wiring and Lighting. (11-8.m)

(1) A sketch of proposed temporary power distribution systems must be submitted to the USACE supervisor for approval or acceptance by the KO or COR for use before temporary power is installed. The sketch must show the location, voltages, and means of protection of all circuits (that is, receptacles, disconnecting means, grounding, GFCIs, and lighting circuits). Include the accepted sketch in the AHA associated with the temporary system. (See para 11-6)

(2) Testing. Check all temporary electrical distribution systems and devices for acceptable polarity, ground continuity, and ground resistance before initial use and before use after modification. GFCIs must be tested monthly. Portable type GFCIs must be tested for designed functionality before each use.

(3) Measure ground resistance and circuits at the time of installation for compliance with paragraph 11-8.l(7). Record the measurement and provide a copy to the USACE supervisor/KO or COR.

(4) Provide vertical clearance of temporary wiring for circuits carrying 600V or less:

(a) 10 feet (3 m) above finished grade, sidewalks, or from any platform.

(b) 12 feet (3.7 m) over areas, other than public streets, alleys, roads, and driveways, that are subject to vehicular traffic other than truck traffic.

(c) 15 feet (4.5 m) over areas, other than public streets, alleys, roads, and driveways, that are subject to truck traffic.

(d) 18 feet (5.5 m) over public streets, alleys, roads, and driveways.

(5) Provide vertical clearance of temporary wiring for circuits carrying more than 600V according to NESC.

(6) Wet Locations.

(a) Only use submersible electric pumps in wet locations when the pump is designed by the manufacturer for such purpose.

(a-1) A QP must install and test each pump.

(a-2) Employees must be trained to operate pumps according to the manufacturer's instructions.

(a-3) When personnel are or could be present in the water during pump operation, the pump must be equipped with a UL 943 class A GFCI. UL 943C class C, D, and E rated special-purpose GFCI devices, used for pump operation, are allowed under engineering supervision.

(a-4) If pump manufacturer does not allow personnel in the area when pumps are used in water, an appropriate Hazardous Energy Control Program (HECP), to include LOTO, must be in place (see chapter 12).

(b) Where a receptacle is used in a wet location, contain it in an enclosure that is weatherproof whether or not an attachment plug is inserted.

(c) All temporary lighting strings in outdoor or wet locations (for example, tunnels, culverts, valve pits, floating plant) must consist of lamp sockets and connection plugs permanently molded to the hard service cord insulation.

(d) Wires must be insulated from their supports.

(7) Temporary Lighting.

(a) Illumination. Provide temporary lighting according to chapter 7. Construction areas, ramps, runways, corridors, offices, shops, and storage areas must be lighted to not less than the minimum illumination intensities listed in 29 CFR 1926.56(a), table D-3 while any work is in progress.

(b) Protect all lamps for general illumination from accidental contact or breakage. Ground all metal-case sockets.

(c) Do not suspend temporary lights by their electric cords unless cords and lights are designed for this means of suspension.

(d) Immediately replace exposed empty light sockets and broken bulbs.

(e) Portable electric lighting used in wet and/or other conductive locations (for example, drums, tanks, vessels, sumps, scroll cases) must be rated and operated at 12 volts or less. 120- volt lights may be used if protected by a GFCI. (See para 11-8.l(9))

(8) Portable Hand Lamps. Portable hand lamps must be wired with flexible cord and a polarized or grounding type attachment plug. If the portable lamp uses an Edison-based lamp holder, the grounded conductor must be identified and attached to the screw shell and the identified blade of the attachment plug. In addition, portable handlamps must comply with the following:

(a) Equip hand lamps with a handle of molded composition or other insulating material.

(b) Do not use metal-shell, paper-lined lamp holders.

(c) Hand lamps must be equipped with a handle and a substantial guard over the bulb. The guard must be attached to the lamp holder or the handle.

(d) Ground metallic guards by means of an equipment grounding conductor run within the power supply cord.

(9) When temporary wiring is used in tanks or other confined spaces, provide an approved disconnect that is properly identified, NRTL labeled, and rated for this application and environment at or near the entrance to such spaces, for the purpose of readily disconnecting the electrical power in case of an emergency.

(10) If type nonmetallic sheathed, nonmetallic sheathed corrosion resistant, and service entrance (SE) cables are used in temporary installations, they must meet NFPA 70 requirements, including the following:

(a) Install along studs, joists, or similar supports while closely following the building finish or running boards.

(b) Attach firmly to each cabinet, box fitting, or fixture by means of a cable clamp. Do not use non-metallic sheathed cables as portable extension cords, where subject to frequent flexing, or as a SE cable and do not lay them on the ground subject to any type of traffic.

(c) Keep temporary lighting circuits separate from electric tool circuits. Receptacle circuits must be dedicated to either temporary lighting or electric tools and must be labeled "LIGHTS ONLY" or "TOOLS ONLY," as applicable.

n. Batteries and Battery Charging. In addition to the following, also adhere to 29 CFR 1926.441 (29 CFR 1926 Subpart K) and 29 CFR 1917.157. (11-8.n)

(1) Stationary energy storage systems (ESS) must be installed in locations designed for the intended ESS technology and aggregate capacity.

Note. NFPA 855 is a source that can be used to comply with this requirement.

(2) Store batteries in enclosures with outside vents or in well-ventilated rooms and arrange them to prevent the escape of fumes, gasses, electrolyte spray, or liquid electrolyte into other areas.

(3) Sufficiently diffuse and ventilate gases from battery storage areas to prevent the accumulation of explosive mixtures.

(4) Battery Storage and Handling.

(a) Provide facilities within 25 feet (7.6 m) of battery handling areas for quick emergency drenching of the eyes and body (see chapter 6).

(b) Use only insulated tools in the battery area to prevent accidental shorting across battery connections.

(c) For lead acid batteries, provide bicarbonate of soda to neutralize any acid spillage (1 lb/gal (0.1 kg/L) of water) for flushing and neutralizing spilled electrolyte and for fire protection.

(5) Battery Charging.

(a) Locate battery charging installations in areas designated for that purpose.

(b) Protect charging apparatus against physical damage.

(c) When charging batteries, keep the vent caps in place to avoid spray of electrolyte. Take care to assure vent caps are functioning.

(d) Prior to charging batteries, check the electrolyte level and adjust it to the proper level.

(e) Keep exit routes from battery areas unobstructed.

(6) PPE. Provide and ensure use of the following PPE for safe battery handling (see chapter 5).

(a) Goggles and face shields appropriate to the chemical and electrical hazard.

(b) Acid-resistant rubber gloves.

(c) Protective rubber aprons and safety shoes.

(d) Lifting devices of adequate capacity, when required.

(7) Lithium-Based Batteries. When lithium-based batteries are present in the workplace, adhere to the following:

(a) Temporary site constructed or permanent construction buildings used for the charging or storage of lithium-based batteries must meet applicable fire protection consensus standards and be approved and documented by a fire protection engineer.

(b) All batteries must be NRTL approved.

(c) All portable containers used for storage or charging of lithium-based batteries must be NRTL approved.

(d) All batteries and portable storage or charging containers used OCONUS must be approved by the host nation NRTL equivalent entity or HQUSACE-SO. Temporary site constructed or permanent construction buildings used for charging or storage must meet the requirements of paragraph 11-8.n(7)(a) above.

o. Hazardous (Classified) Locations. Classify the locations of electrical equipment and wiring based on the properties of the flammable vapors, liquids or gases, or combustible dusts or fibers that may be present and the likelihood that a flammable or combustible concentration or quantity is present. The host employer must document these hazardous locations within the facility. (11-8.o)

(1) All hazardous location installations must comply with the requirements of NFPA 70 and 29 CFR 1910.307 (29 CFR 1910 Subpart S).

(2) If a contract employer or USACE employee believes there is a location that should be classified as a hazardous location, the contract employer must immediately notify the USACE supervisor/KO or COR in writing of the concern. A licensed fire protection professional engineer must perform the hazardous location determination.

(3) All equipment, wiring methods, and installations of equipment in hazardous (classified) locations must be either listed as intrinsically safe or listed for the hazardous location.

p. Underground or Concrete-Encased Electrical Installations. Perform underground electrical installations according to 29 CFR 1926.965 (29 CFR 1926 Subpart V). (11-8.p)

(1) Guarding Underground Openings.

(a) Promptly place warning signs and rigid barricades when covers of manholes, handholes, or vaults are removed.

(b) When an employee enters an underground opening, protect the opening with a barricade, temporary cover, or other guard appropriate for the hazard.

(c) Adequately illuminate underground opening guards and warning signs.

(2) Treat maintenance holes and unvented vaults as confined spaces (see chapter 34).

(3) Smoking is prohibited in maintenance holes and vaults.

(4) Provide ventilation when open flames must be used in manholes.

(5) Before using open flames in maintenance holes or vaults, test the holes/vaults and determine that they are safe or cleared of any combustible gases or liquids.

(6) When underground utilities are exposed (for example, electric, gas, water, telephone, or cables other than the one being worked on), protect them from damage.

(7) Maintain metallic sheath continuity by bonding across the opening, or other equivalent means, when working on buried cable or cable in manholes.

(8) Before cutting into a cable or opening a splice, identify the cable, verify it is the proper cable, and de-energize. Utilize remote cable spiking tools to ground the cable when positive identification is not possible before cutting.

q. Power Transmission and Distribution. The requirements in this subparagraph apply to the erection of new electric transmission and distribution lines and equipment, and the alteration, conversion, and improvement of existing electric transmission and distribution lines and equipment. In addition to the following, also adhere to 29 CFR 1910.269 and 29 CFR 1926.950 (29 CFR 1926 Subpart V). (11-8.q)

(1) Before starting work, evaluate and determine the existing conditions of concern. Conditions of concern include but are not limited to location and voltage of energized lines and equipment, conditions of poles, and location of circuits and equipment including power and communication lines and fire alarm circuits.

(a) Consider electric equipment and lines as energized until test results or other analysis indicate that they are de-energized and have been properly grounded.

(b) New lines or equipment may be considered de-energized and worked as such where the lines or equipment are grounded or where the hazard of induced voltages is not present and adequate clearances or other means are implemented to prevent contact with energized lines or equipment.

(c) Determine the operating voltage of equipment and lines before working on or near energized parts.

(2) Comply with the clearance requirements of either subparagraph (a) or (b) below.

(a) No QP may approach or take any conductive object without a listed insulating handle closer to exposed energized parts than shown in table 11-3 (phase to ground) unless one of the following conditions exists:

(a-1) The QP is insulated or guarded from the energized part (gloves or gloves with sleeves rated for the voltage involved is considered insulation of the QP from the energized part).

(a-2) The energized part is insulated or guarded from the QP and any other conductive object at a different potential.

(a-3) The QP is isolated, insulated, or guarded from any other conductive object(s), as during live-line, bare-hand work.

(b) Do not exceed the minimum phase to ground working distance and minimum clear hot stick distances in table 11-3. The minimum clear hot stick distance refers to the distance from the hot end of live-line tools to the lineman when performing live-line work. If conductor support tools (for example, link sticks, strain carriers, and insulator cradles) are used, the clear length of insulation must be at least as long as the insulator string or as long as the minimum phase to ground distance in table 11-3.

(3) When de-energizing lines and equipment that are operated in excess of 600 volts adhere to the following. In addition, requirements in chapter 12 apply.

(a) Clearly identify the equipment or section of line to be de-energized and isolate them from all sources of voltage.

(b) After all designated switches and disconnects have been opened, rendered inoperable, and tagged and/or locked, conduct visual inspections to ensure that equipment or lines are de-energized.

(c) Apply TPGs on the disconnected equipment or lines to be worked on (see para 11-8.1(10)).

(d) Erect guards or barriers as necessary to adjacent energized lines.

(e) When more than one crew requires the same line or equipment to be de-energized, place a prominent LOTO device for each crew on the line or equipment by the Authorized Individual(s) holding the clearance(s) on the equipment or line.

(f) Upon completion of work on de-energized lines or equipment, each Authorized Individual holding a clearance must determine that all employees in the crew are clear and request a release of the clearance. The TPGs installed will then be removed.

Authorized Individual will report to the utility operator or line operator that all tags and locks protecting the crew may be removed.

(4) When opening or closing a disconnect switch or circuit breaker on a power transmission/distribution line, limit the exposure to potential explosion. Establish safe operating procedures to minimize the risk of explosion.

(5) When working on a line or equipment inside the demarcation zone of a power generation plant, adhere to 29 CFR 1910.269(d) (see chapter 12).

(6) Tools. In addition to the following, also adhere to 29 CFR 1926.951, 29 CFR 1926.955, and 29 CFR 1926.956 (29 CFR 1926 Subpart V).

(a) All hydraulic tools that are used on or around energized lines or equipment must use non-conducting hoses having adequate strength for the normal operating pressures.

(b) All pneumatic tools that are used on or around energized lines or equipment must have non-conducting hoses of adequate strength for the normal operating pressures and have an accumulator on the compressor to collect moisture.

(c) Portable metal or conductive ladders must not be used near energized lines or equipment except in specialized work such as in high voltage substations where nonconductive ladders might present a greater hazard than conductive ladders. Conductive or metal ladders must be prominently marked as conductive, and all precautions must be taken when used in specialized work.

(d) Do not use conductive pull tape or rope when working on or near energized parts.

(7) Material Handling and Storage.

(a) When hauling poles during the hours of darkness, attach illuminated warning devices to the trailing end of the longest pole.

(b) Do not store materials and equipment under energized bus, energized lines, or near energized equipment if it is possible to store them elsewhere. If materials or equipment must be stored under energized lines or near energized equipment, maintain clearance according to table 11-4 and exercise extraordinary caution to maintain these clearances when operating equipment or moving materials near such energized equipment.

(c) Tag lines must be of a non-conducting type when used near energized lines.

(d) Restricted Areas. Do not store material within working spaces of energized lines or equipment within a restricted area.

(8) Overhead Lines and Live-Line Barehand Work. Construct and maintain of overhead lines according to 29 CFR 1926.964 (29 CFR 1926 Subpart V).

(9) Develop an AHA and hold a briefing according to paragraph 11-6 before stringing operations. The following details must be included:

- (a) The plan of operation.
- (b) The type of equipment to be used.
- (c) Grounding devices and procedures to be followed.
- (d) Crossover methods to be employed.
- (e) Clearance authorizations that are required.

(10) Pulling lines and accessories must be inspected regularly and replaced or repaired when damaged or when dependability may be doubtful.

(11) Before stringing parallel to an existing energized transmission line, a competent determination must be made to ascertain if dangerous induced voltage buildups will occur, particularly during switching and ground fault conditions. This determination must be done under direct engineering supervision.

(12) Before using the live-line bare-hand technique on energized high-voltage conductors or parts, check the following:

- (a) The voltage rating of the circuit on which the work is to be performed.
- (b) The clearances to ground of lines and other energized parts involved in the work.
- (c) The voltage limitations of the aerial-lift equipment intended to be used.

(13) All work must be personally supervised by a QP trained and qualified to perform live-line bare-hand work.

(14) Use only tools and equipment designed, tested, and intended for live-line bare-hand work. Keep all tools and equipment clean and dry.

(15) After completing a thorough inspection of the condition and cleanliness of the electrical insulating components and systems of aerial devices that are rated and used

as an insulating device, QPs must test them for compliance with their rating according to the manufacturer's instructions.

r. Work in Energized Substations. Perform work in substations according to 29 CFR 1926.966 (29 CFR 1926 Subpart V). (11-8.r)

(1) Prior to entry each day, authorization must be obtained from the substation operator by the contract employer. Document the authorization and controls and attach to the AHA.

(2) When work is to be done in an energized substation determine if the facilities are energized and any protective equipment and precautions that are necessary for the safety of personnel.

(3) Follow the appropriate approach distances identified in the electrical hazard risk assessments (see para 11-8.b).

(4) Only QPs are allowed to perform work on or adjacent to energized equipment.

(5) Take precautions to prevent accidental operation of relays or other protective devices due to jarring, vibration, or improper wiring.

(6) QPs must control the use of vehicles, gin poles, cranes, and other equipment when in proximity to unguarded exposed conductors.

(7) When a substation fence must be expanded or removed, provide a temporary fence affording similar protection, when the site is unattended. Maintain an adequate interconnection with ground between the temporary fence and permanent fence.

(8) Keep all gates to unattended substations locked except when work is in progress.

(9) When manually operating gang switches, make a visual inspection to ensure all insulators and the switch handle ground are in good condition. Insulating gloves must be worn when operating switch handles if an equipotential zone is not established. (See 29 CFR 1910.269 Appendix C)

s. Operations Near Energized Transmission Lines and Distribution Lines and Equipment. (11-8.s)

(1) Overhead transmission and distribution lines used during construction must be carried on towers and poles that provide safe clearances over roadways and structures, provided that:

(a) Clearances are adequate for the movement of vehicles and for the operation of construction equipment and meet the clearances required in the NESC.

(b) All electric power or distribution lines are placed underground in areas where there is extensive use of equipment having the capability to encroach on the clearances listed in table 11-4 during construction activities.

(c) Overhead outdoor trolley conductors and other portable overhead cables used to supply moveable construction equipment (for example, gantry cranes, mobile cranes, shovels) are protected and meet clearance requirements in the NESC.

(2) Do not perform work activities adjacent to overhead lines until a survey has been conducted to ascertain the safe clearance from energized lines (see para 11-8.b).

(3) Consider all overhead wires energized unless the persons owning such line or operating officials of the electrical utility supplying the line certifies that it is not energized and it has been tested and visibly grounded.

(4) Do not initiate any work activity that could affect or be affected by overhead lines until coordinated with the appropriate utility officials.

(5) Establish and rehearse the standard emergency communication procedures to assure rapid emergency shutdown for all work being conducted on overhead power lines.

t. Mechanical Equipment Operations Near Energized Transmission and Distribution Lines and Equipment. (11-8.t)

(1) Electrically Unqualified Persons operating mechanical equipment near energized lines or equipment for construction or maintenance must comply with 29 CFR 1910.333(c)(3)(i) and (iii) (29 CFR 1910 Subpart S) for distance requirements.

(2) QP's operating mechanical equipment near energized lines or equipment must comply with 29 CFR 1926.959 (29 CFR 1926 Subpart V) when performing construction or maintenance work activities. The MADs referenced in 29 CFR 1926.959(d) (29 CFR 1926 Subpart V) will be in table 11-3 of this chapter.

Note. 29 CFR 1910.269(p) contains identical language to 29 CFR 1926.959.

(3) Do not place or site floating plant and associated equipment within 20 feet (6 m) of overhead transmission or distribution lines.

(4) Unless using protective equipment for the voltage involved, employees standing on the ground must avoid contacting equipment or machinery working near energized lines or equipment.

(5) Bond lifting equipment that is used closer than table 11-4 to energized equipment or lines to an effective ground or consider it to be energized and barricade it.

(6) Mobile cranes and derricks (see chapters 16 and 18).

(a) Work using cranes and derricks for construction or maintenance must comply with 29 CFR 1926.1408 and 29 CFR 1926.1410.

(b) Cranes and other equipment (for example, excavators, forklifts) used to hoist loads with rigging are prohibited from operating when any part of the equipment, load line, or load (including rigging and lifting accessories) is closer than the minimum clearance in 29 CFR 1926.1408 to an energized power line, unless allowed in chapter 16 or 29 CFR 1926.1410.

(c) All mobile cranes and derricks must be effectively grounded when being operated near energized lines or equipment or the equipment be considered energized (see para 11-8.l(10)).

(d) If cage boom guards, insulating links, or proximity warning devices are used on cranes, they must not alter the requirements of any other regulation of this manual, even if such devices are required by law or other regulation. Insulating links must be rated for the energized lines they are working near.

(7) Aerial Lift Trucks. See chapter 18 and paragraph 22-8m.

(a) Use of aerial lift trucks must comply with paragraph 11-8.t(1) for electrically unqualified persons and paragraph 11-8.t(2) for electrically qualified persons.

(b) The aerial device manufacturer must state in the operator's manual and on the instruction plate whether the aerial device is insulating or non-insulating.

(c) Aerial lift trucks must be grounded, barricaded, and considered as energized equipment, or the aerial lift truck must be insulated for the work being performed. Tables 11-3 and 11-4 must be legibly printed on a plate of durable non-conductive material and must be mounted on the bucket or its vicinity to be visible to the operator of the boom.

(d) Equipment or material must not be passed between a pole or structure and an aerial lift while an employee working from the basket is within reaching distance of energized conductors or equipment that are not covered with insulating protective equipment.

u. Work Near Communication Towers. In addition to the following, also adhere to 29 CFR 1910.269(S) and 29 CFR 1926.967(k) (29 CFR 1926 Subpart V). (11-8.u)

(1) Before working near transmitter towers where there is potential for an electrical charge to be induced in equipment or materials, de-energize the transmitter or conduct tests to determine if an electrical charge could be induced.

(2) Electrically ground equipment to the upper rotating structure supporting the boom and attach ground jumper cables to materials being handled by boom equipment when electrical charge could be induced while working near energized transmitters to dissipate induced voltages. Provide crews with nonconductive poles having large alligator clips or other similar protection to attach the ground cable to the load. Workers must use insulating gloves.

v. Communication Facilities. Perform work on communication facilities according to 29 CFR 1910.269 and 29 CFR 1910.268. (11-8.v)

(1) Do not look into an open wave guide or antenna that is connected to an energized electromagnetic source.

(2) If the electromagnetic radiation level within an accessible area exceeds the levels identified in chapter 6, post the area with appropriate signage.

(3) When an employee works in an area where the electromagnetic radiation is unknown or could exceed the levels given in chapter 6, take measurements to ensure that employee's exposure is not greater than that permitted.

11-9. Figures and Tables.

Table 11-1
Limited Approach Boundaries to Exposed Energized Electrical Conductors or Circuit Parts -
Alternating-Current (AC) Systems

Nominal System Voltage³ (Phase to Phase)	Limited Approach Boundary² Overhead Exposed Movable Conductor¹	Limited Approach Boundary² Exposed Fixed Circuit Part[#]
Less than 50 V	Not specified	Not specified
*50 - 150 V	10 feet 0 inches (3.0 m)	3 feet 0 inches (0.9 m) ^{a^}
151 - 300V	10 feet 0 inches (3.0 m)	3 feet 6 inches (1.06 m) ^{a^}
301 - 750 V	10 feet 0 inches (3.0 m)	4 feet 0 inches (1.0 m) ^a
0.751 - 15 kV	10 feet 0 inches (3.0 m)	8 feet 3 inches (2.51 m) ^b
15.1 - 36 kV	10 feet 0 inches (3.0 m)	9 feet 0 inches (2.74 m) ^b
36.1 - 46 kv	10 feet 0 inches (3.0 m)	9 feet 6 inches (2.90 m) ^b
46.1 - 72.5 kV	10 feet 8 inches (3.25 m)	10 feet 0 inches (3.0 m) ^b
72.6 - 121 kV	12 feet 4 inches (3.76 m)	10 feet 9 inches (3.28 m) ^c

**Table 11-1
Limited Approach Boundaries to Exposed Energized Electrical Conductors or Circuit Parts -
Alternating-Current (AC) Systems — Continued**

Nominal System Voltage³ (Phase to Phase)	Limited Approach Boundary² Overhead Exposed Movable Conductor¹	Limited Approach Boundary² Exposed Fixed Circuit Part[#]
138 - 145 kV	13 feet 2 inches (4.01 m)	11 feet 4 inches (3.45 m) ^c
161 - 169 kV	14 feet 0 inches (4.27 m)	11 feet 10 inches (3.61 m) ^c
170 - 242 kV	16 feet 5 inches (5.00 m)	13 feet 8 inches (4.17 m) ^c
345 - 362 kV	20 feet 4 inches (6.20 m)	18 feet 3 inches (5.56 m) ^c
400 - 420 kV	20 feet 4 inches (6.20 m)	20 feet 11 inches (6.38 m) ^c
500 - 550 kV	26 feet 8 inches (8.13 m)	23 feet 8 inches (7.21 m) ^c
765 - 800 kV	35 feet 0 inches (10.67 m)	29 feet 8 inches (9.04 m) ^c

Note:

* This includes circuits where the exposure does not exceed nominal 120 volts.

¹ Calculated from 29 CFR 1910.333(i)(3)(i) (2014 ed.). Exposed movable conductors describe a condition in which the distance between the conductor and a person is not under the control of the person, for example, pole supported overhead line conductors.

² USACE Limited Approach Boundaries are different from NFPA 70E (2020 ed.). All dimensions are distance from exposed energized electrical conductors or circuit parts to worker.

³ Voltage ranges per ANSI C84.1, table 1 (2020 ed.). For AC single-phase systems above 250 volts, select the range that is equal to the systems maximum phase to ground voltage multiplied by 1.732.

^a NFPA 70 (2020 ed.) table 110.26(A)(1), column 2.

^b NESC (2017 ed.) table 431-1 value plus 6 feet unqualified person falling forward inadvertent movement adder.

^c NESC (2017 ed.) table 431-1, sea level to 3000 feet column value plus 6 feet unqualified person falling forward inadvertent movement adder.

[^] Work within an energized industrial control panel provided all following conditions are met; the circuit being worked on is placed in an ESWC, the voltage levels of any conductor inside the industrial control panel is less than or equal to 300V AC phase to phase or 130V DC, shock hazards presented by energized conductors can be mitigated by avoiding contact, and the work site has documented AHJ approval.

[#] In locations covered by NESC (2017 ed.) and 29 CFR 1910.269 (2014 ed.), considered Generation, Transmission, or Distribution, it is assumed that Unqualified Persons are restricted from access or are continuously escorted and the limited approach distance requirement to deenergize equipment would not apply and table 11-4 MADs must be observed unless energized work is authorized and being performed. Temporary barriers should still be erected at the distances listed in column 3 above to let other Qualified Persons work is being performed and to stay out unless authorized.

Table 11-2
Limited Approach Boundaries to Exposed Energized Electrical Conductors or Circuit Parts -
Direct-Current (DC) Systems

Nominal Potential Difference Phase to Phase	Limited Approach Boundary Exposed Movable Conductor	Limited Approach Boundary Exposed Fixed Circuit Part
Less than 50 V	Not specified	Not specified
-0 - 300 V	10 feet 0 inches (3.0 m)	3 feet 6 inches (1.0 m)
0.301 - 1 kV	10 feet 0 inches (3.0 m)	3 feet 6 inches (1.0 m)
1.1 - 5 kV	10 feet 0 inches (3.0 m)	5 feet 0 inches (1.5 m)
5 - 15 kV	10 feet 0 inches (3.0 m)	5 feet 0 inches (1.5 m)
15.1 - 45 kV	10 feet 0 inches (3.0 m)	8 feet 0 inches (2.5 m)
45.1 - 75 kV	10 feet 0 inches (3.0 m)	8 feet 0 inches (2.5 m)
75.1 - 150 kV	10 feet 8 inches (3.3 m)	10 feet 0 inches (3.0 m)
150.1 - 250 kV	11 feet 8 inches (3.6 m)	11 feet 8 inches (3.6 m)
250.1 - 500 kV	20 feet 0 inches (6.0 m)	20 feet 0 inches (6.0 m)
500.1 - 800 kV	26 feet 0 inches (8.0 m)	26 feet 0 inches (8.0 m)

Note:

¹ All dimensions are distance from exposed energized electrical conductors or circuit parts to worker.

² Exposed movable conductors describe a condition in which the distance between the conductor and a person is not under the control of the person, for example, pole supported overhead line conductors.

**Table 11-3
Qualified Person (QP) Minimum Approach Distances (MADs) - Alternating-Current (AC) Systems**

Nominal Voltage[#] (Phase to Phase)	Distances^{##} Phase-to-ground exposure	Distances^{##} Phase-to-phase exposure
*50 - 300 V	Avoid Contact	Avoid Contact
*301 - 750 V	1 foot 1 inch (0.33 m)	1 foot 1 inch (0.33 m)
0.751 - 5 kV	2 feet 1 inch (0.63 m)	2 feet 1 inch (0.63 m)
5.1 - 15 kV	2 feet 2 inches (0.65 m)	2 feet 3 inches (0.68 m)
15.1 - 36 kV	2 feet 7 inches (0.77 m)	3 feet 0 inches (0.89 m)
36.1 - 46 kV	2 feet 10 inches (0.84 m)	3 feet 3 inches (0.98 m)
46.1 - 72.5 kV	3 feet 4 inches (1.0 m)	4 feet 0 inches (1.2 m)
72.6 - 121 kV	3 feet 9 inches (1.13 m)	4 feet 8 inches (1.42 m)
122 - 145 kV	4 feet 4 inches (1.3 m)	5 feet 5 inches (1.64 m)
146 - 169 kV	4 feet 10 inches (1.46 m)	6 feet 5 inches (1.94 m)
170 - 242 kV	6 feet 8 inches (2.01 m)	10 feet 2 inches (3.08 m)
243 - 362 kV	11 feet 3 inches (3.41 m)	18 feet 2 inches (5.52 m)
363 - 420 kV	14 feet 0 inches (4.25 m)	22 feet 5 inches (6.81 m)
421 - 550 kV	16 feet 8 inches (5.07 m)	27 feet 1 inch (8.24 m)
551 - 800 kV	22 feet 7 inches (6.88 m)	37 feet 5 inches (11.38 m)

* For single-phase systems, use voltage-to-ground.

Voltage ranges per ANSI C84.1, table 1 (2020 ed.).

Based on 29 CFR 1910.269 tables R-6 and R-7 (2014 ed.).

Note:

- ¹ Employers may use the MADs in this table provided the work site is at an elevation of 900 meters (3,000 feet) or less. If employees will be working at elevations greater than 900 meters (3,000 feet) above mean sea level, calculations will be made under engineering supervision.
- ² Table R-3 of 29 CFR 1910.269 (2014 ed.) may also be used under engineering supervision.
- ³ Table R-8 of 29 CFR 1910.269 (2014 ed.) or NFPA 70E (2020 ed.) table 130.4(E)(b) will be used for the DC MADs.
- ⁴ Tables found in NESC (2017ed.) or 29 CFR 1910.269 Appendix B (2014 ed.) may also be applied which are based on known transient overvoltage levels of the system for the MADs under engineering supervision.
- ⁵ NFPA 70E calls the MAD the Restricted Approach Boundary.

**Table 11-4
Mechanical Equipment and Unqualified Persons MADs from Overhead Lines and Equipment -
Alternating-Current (AC) Systems: Calculated Values**

Nominal Voltage# (Phase to Phase)	Calculated Minimum Clearance Distances##
50 kV or less	10 feet 0 inches (3.0 m)
51 - 72.5 kV	10 feet 8 inches (3.25 m)
72.6 - 121 kV	12 feet 4 inches (3.76 m)
138 - 145 kV	13 feet 2 inches (4.01 m)
161 - 169 kV	14 feet 0 inches (4.27 m)
170 - 242 kV	16 feet 5 inches (5.00 m)
345 - 362 kV	20 feet 4 inches (6.20 m)
400 - 420 kV	22 feet 4 inches (6.81 m)
500 - 550 kV	26 feet 8 inches (8.13 m)
765 - 800 kV	35 feet 0 inches (10.67 m)

Voltage ranges per ANSI C84.1, table 1 (2020 ed.).

Based on values calculated per 29 CFR 1910.333(c)(3)(iii)(A) (2014 ed.).

See chapters 16 and 18. Crane and Derrick use in construction and maintenance will comply with 29 CFR 1926.1408 & 1410 (2014 ed.) and use table A in 29 CFR 1926.1408 for allowable distances during operation unless a minimum clearances is established under 29 CFR 1926.1410 rules.

Note:

- ¹ When an unqualified person is working in an elevated position near overhead lines or in a location that allows access from the ground near enough that a hazard might exist, the distances above must be maintained for the person and the longest conductive object or tool being used that may breach the distances listed above per 29 CFR 1910.333(c)(3)(i)(A) (2014 ed.).
- ² For mobile equipment transit beneath overhead lines with the structure lowered, subtract 6 feet 0 inches from the numbers above per 29 CFR 1910.333(c)(3)(iii)(A)(1) (2014 ed.).
- ³ For properly rated insulated aerial lift equipment (for example, electrical bucket truck) operated by a QP, distance values in this table must be maintained for the uninsulated/grounded portion of the lift per 29 CFR 1910.333(c)(3)(iii)(A)(3) (2014 ed.).

11-10. Checklists and Forms.

ENG Form 6277, Energized Electrical Work Permit (EEWP) (non-mandatory)
(<https://www.publications.usace.army.mil/LinkClick.aspx?fileticket=s3qil7RUX-0%3d&tabid=16438&portalid=76&mid=43543>)

Chapter 12

Control of Hazardous Energy

The requirements of this chapter are applicable to contractors only.

Note. HEC activities for USACE-owned/operated facilities must be performed according to ER 385-1-31, in addition to any regional HECF and local supplements.

12-1. References.

- a. ANSI/ASSP A10.44, Control of Energy Sources (Lockout/Tagout) For Construction and Demolition Operations (<https://webstore.ansi.org/>) (12-1.a)
- b. ANSI/ASSP Z244.1, The Control of Hazardous Energy, Tagout and Alternative Methods (<https://webstore.ansi.org/>) (12-1.b)
- c. ER 385-1-31, The Control of Hazardous Energy (<https://www.publications.usace.army.mil/USACE-Publications/Engineer-Regulations/>) (12-1.c)
- d. NFPA 70E, Standard for Electrical Safety in the Workplace (<https://www.nfpa.org/Codes-and-Standards>) (12-1.d)
- e. 29 CFR 1910.147, The Control of Hazardous Energy (Lockout/Tagout) (<https://www.govinfo.gov/content/pkg/CFR-2020-title29-vol5/pdf/CFR-2020-title29-vol5-sec1910-147.pdf>) (12-1.e)
- f. 29 CFR 1910.269, Electric Power Generation, Transmission, and Distribution (<https://www.govinfo.gov/content/pkg/CFR-2020-title29-vol5/pdf/CFR-2020-title29-vol5-sec1910-269.pdf>) (12-1.f)
- g. 29 CFR 1910.333, Selection and Use of Work Practices (<https://www.govinfo.gov/content/pkg/CFR-2020-title29-vol5/pdf/CFR-2020-title29-vol5-sec1910-333.pdf>) (12-1.g)
- h. 29 CFR 1915.89, Control of Hazardous Energy (Lockout/Tags-Plus) (<https://www.govinfo.gov/content/pkg/CFR-2020-title29-vol7/pdf/CFR-2020-title29-vol7-sec1915-89.pdf>) (12-1.h)
- i. 29 CFR 1917.48, Conveyors (<https://www.govinfo.gov/content/pkg/CFR-2020-title29-vol7/pdf/CFR-2020-title29-vol7-sec1917-48.pdf>) (12-1.i)
- j. 29 CFR 1918.64, Powered Conveyors (<https://www.govinfo.gov/content/pkg/CFR-2020-title29-vol7/pdf/CFR-2020-title29-vol7-sec1918-64.pdf>) (12-1.j)
- k. 29 CFR 1926.64, Process Safety Management of Highly Hazardous Chemicals (<https://www.govinfo.gov/content/pkg/CFR-2020-title29-vol8/pdf/CFR-2020-title29-vol8-sec1926-64.pdf>) (12-1.k)
- l. 29 CFR 1926.417, Lockout and Tagging of Circuits (<https://www.govinfo.gov/content/pkg/CFR-2020-title29-vol8/pdf/CFR-2020-title29-vol8-sec1926-417.pdf>) (12-1.l)

m. 29 CFR 1926.702, Requirements for Equipment and Tools
(<https://www.govinfo.gov/content/pkg/CFR-2020-title29-vol8/pdf/CFR-2020-title29-vol8-sec1926-702.pdf>) (12-1.m)

n. 29 CFR 1926.950, General (Electric Power Transmission and Distribution)
(<https://www.govinfo.gov/content/pkg/CFR-2020-title29-vol8/pdf/CFR-2020-title29-vol8-sec1926-950.pdf>) (12-1.n)

12-2. Definitions.

a. Affected Person. A person whose position requires them to operate or use a system that is under lockout or tagout or whose position requires them to work in an area where a system that is under lockout or tagout is being serviced or maintained. (12-2.a)

b. Authorized Individual Hazardous Energy Control (HEC). Someone who meets the criteria for a QP as defined in this manual (see paras 1-2 or 2-2, as applicable), who is designated in writing to request, receive, implement, and remove hazardous energy isolation procedures. (12-2.b)

c. Commingled. A term used to describe the cable runs within the electric power generation, transmission, and distribution facility (for example, cable trays, wiring ducts, conduit installations) in which the wiring from the utilization equipment (for example, lights, cafeteria equipment, sump pumps) is run together with wiring from power generation equipment (for example, boiler pumps, transformer fans, coal handling operations). (12-2.c)

d. Construction. Construction, alteration and/or repair, includes painting and decorating. (12-2.d)

e. Contractor Controlled Site. A system, site, or area clearly defined and accepted by the KO or COR, in which the contractor is responsible for the application of their Site-Specific Energy Control Plan (SSECP) and the development and use of hazard isolation procedures (HIPs). (12-2.e)

f. Energy Isolation Device. A physical device that prevents the transmission or release of energy. Includes but is not limited to manually operated circuit breakers, disconnect switches, slide gates, slip blinds, line valves, blocks, or similar devices, capable of blocking or isolating energy, with a position indicator. The term does not include push buttons, selector switches, and other control circuit type devices. (12-2.f)

g. Hazardous Energy. Any energy including but not limited to mechanical (for example, power transmission apparatus, counterbalances, springs, pressure, gravity), pneumatic, hydraulic, electrical, chemical, nuclear, and thermal (for example, high or low temperature) energies, which could cause injury to employees. (12-2.g)

h. Hazardous Energy Control Program (HECP). An organization's methods and mindset for the control of hazardous energy at the corporate level. The HECP document speaks in generalities and is intended to be all-encompassing. It covers all scenarios an organization may encounter. It does not contain information pertaining to a specific location. It includes definitions, roles and responsibilities, methods and procedures, training, program review, and reportable incident history. (12-2.h)

i. Hazard Isolation Procedure (HIP). A written step-by-step procedure for the control of hazardous energy pertaining to a specific task or work area that has the potential for the release of hazardous energy. This includes identifying all hazards associated with the work item, total number of isolation points, procedural steps for de-energizing and isolating with lockout, and requirements for testing the effectiveness of energy control measures. The HIP must also address the step-by-step procedures for the restoration of equipment. (12-2.i)

j. Incidental Individual. An individual who under normal circumstances, would not be in an area where a system is under lockout and/or tagout, but is required to enter or pass through such an area. (12-2.j)

k. Isolation. An activity that physically prevents the transmission or release of energy. (12-2.k)

l. Issuing Individual. Is a person with jurisdiction over an area or project, for example, they may be the operator in charge of a shift at a powerhouse or lock, the supervisory engineer of a project or facility, or other person having operational control or system to be placed under HEC procedures. (12-2.l)

m. Lockout. A form of HEC using the placement of a lockout device, according to established procedures, on an energy-isolating device to ensure that the energy-isolating device and the system being controlled cannot be operated until the lockout device is removed. (12-2.m)

n. Lockout Device. A device that uses a positive means, such as a key or combination lock, to hold an energy-isolating device in the safe position and prevent the energizing of a system. (12-2.n)

o. Maritime Industry. Includes the construction, repair, and scrapping of vessels, as well as the movement of cargo and other materials. (12-2.o)

p. Site-Specific Energy Control Plan (SSECP). A written plan for a specific location that clearly and specifically identifies the hazardous energy sources and outlines the scope, purpose, and procedures for periodic inspections, procedural steps for creating and updating HIPs, site specific training documents, and assignment of roles and responsibilities defined in the HECP. (12-2.p)

q. Stored Energy. Energy (for example, electrical, mechanical, chemical, hydraulic, pneumatic, gravitational) that might be found in a charge capacitor, a loaded spring, chemical solutions, flood control barrier, or other similar hazardous form. (12-2.q)

r. Tagout. A form of HEC procedure using the placement of a tagout device according to established procedures, on an energy-isolating device to indicate that the energy-isolating device and the system being controlled may not be operated until the tagout device is removed. (12-2.r)

s. Tagout Device. A prominent warning device, such as a tag with a means of attachment, which can be securely attached to an energy-isolating device according to established procedures to indicate that the energy-isolating device and system being controlled may not be operated until the tagout device is removed. (12-2.s)

12-3. Personnel Required Qualification/Training.

a. Prior to commencing activities on a project, provide training according to the SSECP. The training must include the purpose and function of the HIPs. The HIPs will be understood by individuals and the individual will possess the knowledge and skills required for the safe application, usage, and removal of energy-isolating devices. Document all training. Documentation will include names of individuals trained; the time, date, and locations of training; the name and qualifications of the trainer. (12-3.a)

b. Authorized Individuals. Each Authorized Individual must be trained in the recognition of applicable hazardous energy sources, the type and magnitude of the energy available in the workplace, and the means and methods necessary for energy isolation and control. (12-3.b)

c. Affected Person. Each Affected Person must be instructed in the purpose and use of the HIPs. (12-3.c)

d. Incidental Individuals. All other individuals whose work operations are or may be in an area where energy control procedures may be utilized. These individuals must be instructed about the procedure and about the prohibition relating to attempts to restart or reenergize machines or equipment which are locked out or tagged out. (12-3.d)

e. Tags. When tagout systems are used (that is, only when lockout is not possible), individuals must be trained in the limitations of tags (see para 12-8.b). (12-3.e)

f. Retraining. Retrain Authorized Individuals and Affected Persons in HIPs whenever any of the following conditions exists: (12-3.f)

(1) There is a change in job responsibilities or a change in systems or processes that present a new energy control hazard.

(2) A periodic inspection reveals, or there is reason to suspect the presence of, inadequacies in or deviations from the individual's knowledge or use of HIPs.

(3) A project runs for more than one year, and then annually thereafter.

g. The retraining must reestablish employee proficiency and introduce new or revised control methods and procedures, as necessary. (12-3.g)

12-4. Roles and Responsibilities.

When working on or near any system that produces, uses, or stores hazardous energy, a SSECP is required.

a. USACE-owned/operated facilities and activities must comply with ER 385-1-31 and any regional HECP as well as local supplements in lieu of paragraph 12-4. (12-4.a)

b. On contractor-controlled sites: (12-4.b)

(1) When USACE employees are affected by the contractor managed SSECP (for example, QARs on construction sites), they must comply with the contractor's SSECP.

(2) The contractor will utilize the flowchart process included in figure 12-1 and the requirements of this chapter and ANSI Z244.1 to develop the site-specific requirements that must be included in the SSECP. When electricity is a potential energy source, the requirements of NFPA 70E apply. The contractor must submit the SSECP as part of their APP to the KO or COR for acceptance.

(3) Prepare a HIP for KO or COR approval prior to energization/de-energization or any activity that results in the accumulation or discharge of potential energy.

(4) The KO or COR and the prime contractor must ensure that their own personnel and sub-contractors understand and comply with the SSECP and HIPs. The prime contractor must coordinate the work to ensure all personnel affected by a hazardous energy are notified before starting any associated HIP.

(5) Review and update HIPS, as necessary, and submit them to the KO or COR with the AHA for each DFOV. HIPs cannot be initiated until these procedures have been accepted by the KO or COR.

(6) The prime contractor, as the controlling contractor, is responsible for the HIPs, periodic inspections, and training verification of all their sub-contractors. The prime and the sub-contractors must fully coordinate all HIP activities with one another throughout the planning and performance of work. Discuss and coordinate the procedures that will be used to ensure everybody is protected from hazardous energy.

c. When contractor work involving hazardous energy will be performed at or on a USACE-operated facility, the contractor must coordinate a meeting with the KO or COR, facilities personnel, and local SOHO on which of the following scenarios will be followed as it pertains to HEC. The meeting must be documented and provided to the local SOHO along with the KO or COR and issuing individual(s). (12-4.c)

(1) When the contractor is to adhere to a USACE HECP, the contractor must provide necessary equipment for LOTO and, depending on their specific job responsibilities, require site authorization and possess certain qualifications to perform specific work covered by a local USACE HEC program.

(2) When a contractor-controlled site is designated, the contractor's HECP must adhere to paragraph 12-4.

(a) USACE must inform the contractor in writing of any known special or unique hazards that are related to the machinery, equipment, or process to which the contractor could be exposed.

(b) The KO or COR and the contractor must fully coordinate all HEC activities with one another through the planning and implementation of these activities.

(c) Both parties must ensure that their own personnel understand and comply with rules and restrictions of the procedures agreed upon to be used for the job and ensure that their employees affected by the HEC activity are notified when transfer of HEC responsibilities occur.

(d) When there is more than one prime contractor on USACE properties, USACE must ensure coordination of all HEC activities and inform each contractor in writing of any crossover of HEC activities.

(e) To eliminate confusion or to clearly differentiate and standardize on contractor-controlled lockouts, USACE may require locks and tags that are coordinated with the site lock and tag system. Communication is a key element of a HECP and a clear lock and tag identity with assigned responsibility is important.

(f) USACE power generation and transmission projects must share information with the contractor according to 29 CFR 1926.950.

(3) Under certain circumstances, the AHJ (see chapter 11) may determine that the contractor is not considered a QP in terms of HEC (for example, painting of equipment) and USACE will be responsible for the procedures. Under this circumstance, the USACE project must obtain approval from the AHJ prior to initiating HEC activities.

(4) When USACE remains responsible for the HEC, the contractor must still be experienced in HEC and will determine if the equipment is in a safe condition, but may not be aware of the complete isolation procedure:

(a) USACE must establish and verify the equipment is in a safe condition.

(b) The contractor must verify the equipment is in a safe condition and place a lock at each isolation point.

(c) The contractor should be vetted or evaluated regarding their competence related to the control of hazardous energy by the AHJ or designated representative. A copy of the credentials used to vet the contractor must be kept with the local USACE HEC program for the duration the contractor is performing work at the project.

12-5. Inspection Requirements.

a. A preparatory meeting and inspection with the KO or COR and contractor personnel must be conducted to coordinate HEC activities. This meeting/inspection must be documented, and a copy maintained in the SSECP. (12-5.a)

(1) Individuals must be trained and tested prior to working on USACE facilities where the USACEs SSECP is in use to ensure they are knowledgeable of the procedures.

(2) Contractors must ensure that all of their employees and subcontractors are trained and knowledgeable in the SSECP.

(3) Where HEC procedures affect USACE and contractors, USACE and contractor Authorized Personnel must participate in the inspection to ensure that the SSECP and HIPs are in place and all individuals are properly trained.

b. Periodic Inspections. Authorized Individuals, other than the one(s) utilizing the energy control procedure being inspected that are knowledgeable in the SSECP and HIP, must perform periodic inspections to ensure that all Authorized Individuals are following the SSECP and HIP. (12-5.b)

(1) The periodic inspection must assess the following:

(a) The steps in the HIP are being followed.

(b) The individuals involved are carrying out their responsibilities under the HIP.

(c) The HIP is adequate to provide the necessary protection, and if inadequate, what modifications are needed.

(d) Be, or accompanied by, a Qualified Individual.

(2) Inspections must include a demonstration of at least one HIP while the clearance or lockout is in progress to ensure the HIP is being properly followed. Each type of HIP must be inspected annually.

(3) Conduct an interview of randomly selected Authorized Individuals performing the HIP to assess their knowledge of the policy, procedures, and their individual responsibilities.

(4) Document all periodic inspections. Identify any deficiencies identified and/or corrected. Include a copy in the SSECP.

(5) Corrective actions related to the individual HIPs will be communicated to all Affected and Authorized Individuals. Corrective actions related to the SSECP will require re-training of all individuals. (See para 12-3)

Note. It is recommended that emphasis be placed on conducting inspections when new contractors and/or employees start on a project, a new DFOW is entered, significant changes in the project energy systems (for example, pressurization of hydraulic or steam systems, change in electrical power systems), or any change that introduces a new potential energy source that results in changes to established procedures.

12-6. Activity Hazard Analysis (AHA) Requirements.

Develop AHAs according to paragraphs 1-6 or 2-6, as applicable. Additionally, AHAs involving HEC must adhere to the following:

a. When the activity requires the control of hazardous energy, a HIP for the activity being performed must be attached to and referenced in the AHA. An AHA by itself will not be considered a HIP. For AHAs that have been previously accepted by the KO or COR, the HIP alone must be submitted for review. (12-6.a)

b. When preparing the AHA, the HIP must also be reviewed by an Authorized Individual to ensure it is still valid and that there have been no changes in the configuration that would require a change in the HIP. (12-6.b)

c. The AHA and the HIP must be provided to and accepted by the KO or COR prior to performing these activities. (12-6.c)

12-7. Minimum Plan Requirements.

a. Site-Specific Energy Control Plan (SSECP). When a contractor SSECP is required for work on or near any system that produces, uses, or stores hazardous energy, the SSECP must be site-specific and developed according to figure 12-1 and ANSI Z244.4, and when electricity is a potential energy source, the plan must also include the required elements of NFPA 70E. The plan must clearly and specifically

outline the scope, purpose, authorization, roles and responsibilities, and techniques to be used to include the following: (12-7.a)

(1) Procedures to identify how, when, and who will develop or revise equipment-specific HIPs to address:

(a) New machine, equipment, or process acquisition.

(b) Changes to existing machines, equipment, or processes.

(c) Correction of identified HEC deficiencies and addition of any HEC improvements that can be generated.

(2) Procedures to establish responsibilities for ensuring that procedures accurately reflect the current requirement and are effective in controlling machine, equipment, or process hazardous energy.

(3) An inventory/index of all HIPs that includes the date the HIP was developed, reviewed, validated, and revised.

(4) Identification of any similar machine, equipment, or process that fall under the same HIP and identify how energy sources differ.

(5) Means of coordinating and communicating HEC activities with all site personnel to include contractor, sub-contractor, government, suppliers, public, visitors, or any other personnel that may be affected to ensure continuity of protection.

(6) Responsibilities for the placement, removal, and transfer of locks, tags, and other energy isolation devices.

(7) Responsibilities and means of accounting for placing and removing temporary protective grounds.

(8) Responsibilities and requirements for testing the system to verify the effectiveness of isolation and control.

(9) Coordination (that is, shift or schedule change) necessary to ensure total continuity of HEC protection during shift or personnel change.

(10) Details of emergency procedures.

(11) Procedural steps and responsibilities for daily and periodic inspections that are conducted to ensure that all requirements of the SSECP and HIP are being followed and documented. Document the inspections and specify on which system the HIP was inspected, the date of the inspection, the names of employees performing and included in the inspections, and any deficiencies in complying with the HIP. (See para 12-5)

(12) The means to enforce compliance with the SSECP.

b. Hazard Isolation Procedures (HIPs). HIPs must be developed for each unique machine, equipment, or process for the control of hazardous energy. The HIP must be posted at or near the point of use, or otherwise readily available for Authorized Individuals to review and use. An example of a non-mandatory HIP is provided in figure 12-2. The HIP must include the following: (12-7.b)

(1) A specific statement of the intended use of the procedure.

(2) Identification of the machine, equipment, or process.

(3) Listing of all required energy-isolating devices and the magnitude of each hazardous energy source and its location.

(4) Specific procedural steps for shutting down, isolating, blocking, securing, and relieving stored or residual hazardous energy.

(5) Specific procedural steps for the placement, removal, and transfer of lockout or tagout devices and the responsibility for them.

(6) Specific requirements for testing the machine or equipment to determine and verify the effectiveness of the lockout devices, tagout devices, and other energy control measures.

(7) A development, validation, and revision date.

12-8. General Requirements.

a. Energy Isolating Procedures. (12-8.a)

(1) The HIP for the machine, equipment, or process must be posted at or near the point of use, or otherwise be readily available for Authorized Individuals to review and use.

(2) Locks or other positive means of control must always be used when the energy isolation involves equipment that is accessible by the public.

(3) Before work (that is, servicing, maintenance, testing, installation, removal) is performed on or near any system that produces, uses, or stores hazardous energy in which the unexpected energization, startup, or release of stored energy could occur, an SSECP to include associated HIPs and AHAs must be developed and accepted by the KO or COR. The SSECP and associated HIPs and AHAs must be reviewed by all Authorized Individuals to ensure all energy sources are controlled and they understand the procedures to be followed. (See paras 12-4, 12-6, and 12-7)

b. Lockout and Tagout Devices. (12-8.b)

(1) Systems with energy isolating devices that are capable of being locked out must be locked out. If an energy isolating device is not capable of being locked out, the HIP must identify tagout procedures providing full personnel protection.

(a) Comply with all tagout requirements of this manual and of the HIP.

(b) Attach the tag to the same location, if possible, that the lock would have been attached. If this is not possible, then attach the tag as close as safely possible to the device and in a position that is immediately obvious to anyone attempting to operate the device.

(c) Employ additional means to provide a level of protection commensurate with that provided by a lock. For example, placement of the tag in a manner that inhibits operation of the energy isolating device, removal of an isolating circuit mechanism, blocking of a control switch, opening of an extra disconnecting device, removal of a valve handle to reduce the likelihood of inadvertent energizing.

(d) When only tags are used (the use of locks is not possible), instruct individuals in the following requirements and limitations of tags:

(d-1) Tags must be legible and understood by all Authorized, Affected, and Incidental Individuals.

(d-2) Tags and their means of attachment must be made of materials that will withstand the environments encountered in the workplace.

(d-3) Securely attach tags to energy isolating devices so that they cannot become inadvertently or accidentally detached during use.

(d-4) Do not remove tags without authorization of the Authorized Individual and never bypass, ignore, or otherwise defeat them.

(d-5) Tags are essentially warning devices affected to energy isolating devices and do not provide the physical protection of a lock. Tags may evoke a false sense of security.

(2) Only Authorized Individuals may perform LOTO.

(3) Notify all Affected Persons of LOTO before and upon completion of the application and removal of locks or tags.

(4) Locks and tags used for LOTO must:

(a) Be capable of withstanding the environment that they are exposed to for the maximum period of time the exposure is expected.

(b) Indicate the identity of the Authorized Individual applying the device.

(c) Be of a unique design or color to readily identify them as belonging to the LOTO program.

(d) Not be used for anything other than LOTO activities.

(e) Identify the person who applied the lock or tag. Locks may have a tag attached with the individual's name and/or photograph which will satisfy this requirement.

(f) Locks must be substantial enough to prevent removal without the use of excessive force or unusual techniques (for example, the use of bolt cutters).

(g) Tags must, in addition, meet all of the following requirements:

(g-1) Have a standardized (within a project) print and format.

(g-2) Be constructed and printed so that exposure to weather conditions, UV light, wet or damp locations, or corrosive environments will not cause the tag to deteriorate or the message to become illegible.

(g-3) Be attached by means that are: non-reusable, substantial enough to prevent inadvertent or accidental removal; attachable by hand; self-locking; non-releasable with a minimum unlocking strength of no less than 50 lbs. (22.7 kg); and have the basic characteristics of being at least equivalent to a one-piece, all environment-tolerant nylon cable tie.

(g-4) Warn against the hazardous condition resulting from system energization and include wording such as "DANGER - DO NOT START, OPEN, CLOSE, ENERGIZE, OPERATE".

(5) To eliminate confusion or to clearly differentiate and standardize contractor-controlled lockouts, USACE may require locks and tags that are coordinated with the site lock and tag system. Communication is a key element of a HEC Program and a clear lock and tag identity with assigned responsibility is important.

(6) Application and Removal of Lockout and Tagout Devices.

(a) Authorized Individual must ensure that all energy isolating devices needed to control energy to or within the system are identified and that the system is shut down, isolated, blocked and secured according to the HIP.

(b) Any system operated by a remotely controlled source must be completely isolated such that it cannot be operated by that or any other source.

(c) The Authorized Individual must affix a lockout and/or tagout device to each energy isolating device according to the HIP.

(d) Where there is a possibility of re-accumulation of stored energy to a hazardous level, continue to verify isolation until the energy control procedure is complete.

(e) Before starting work on systems that have been locked/tagged out, the Authorized Individual must verify that isolation and de-energization of the system have successfully been accomplished.

(7) TPGs, if applicable. Following the application of locks and/or tags to energy isolating devices, relieve or make safe all potentially hazardous or stored residual energy.

(a) Identify and account for protective grounds in the manner as identified in the contractor's SSECP and HIP.

(b) The Authorized Individual (or their designee) is responsible for ensuring the control of residual energy and for placing and removing TPGs according to the contractor's ESP (see chapter 11).

(8) Before LOTO devices are removed and energy restored to the system, the Authorized Individual must ensure that the following actions have been taken:

(a) The work area has been inspected and all nonessential items (for example, tools and materials) have been removed from the system, the system components are operationally intact, and all personnel have been safely positioned or removed from the area.

(b) All Affected and Incidental Individuals have been notified that the LOTO devices are about to be removed.

(9) Only the Authorized Individual who applied the LOTO device is permitted to remove such devices from the associated energy isolating devices. When the individual is not available, the device(s) may be removed by another Authorized Individual appointed by and under the direction of the contractor PM or contractor designated authority provided the following are complied with:

(a) The contractor ensures that the individual appointed to remove the LOTO devices is knowledgeable in the HIP applied.

(b) Such individual and the requirements for transferring removal authority to from the new Authorized Individual are identified in the SSECP. (See para 12-7.a)

(c) The contractor verifies that the Authorized Individual who applied the device is not at the facility.

(d) The contractor designated authority makes all reasonable efforts to contact the Authorized Individual to inform them that the LOTO devices are to be removed. If a group clearance is involved, then an attempt must be made to have all Affected Persons sign off on the clearance or they must be contacted by phone. If contact cannot be made, then the lift may only made if after all necessary precautions are taken.

(e) The Authorized Individual is immediately notified of the removal upon returning and prior to resuming any work.

(10) Full Personnel Protection. When tagout is used in place of lockout, full personnel protection is provided when:

(a) The tagout device is attached at the same location as the lockout device would have been attached.

(b) All tagout-related requirements of this manual have been complied with.

(c) Additional means have been taken to provide a level of safety commensurate with that of a lockout device. Such additional means include the removal of an isolation circuit element, blocking of a control switch, opening, and tagging an extra disconnecting device (separated by distance), or the removal of a valve handle to reduce the likelihood of being energized.

12-9. Figures and Tables.

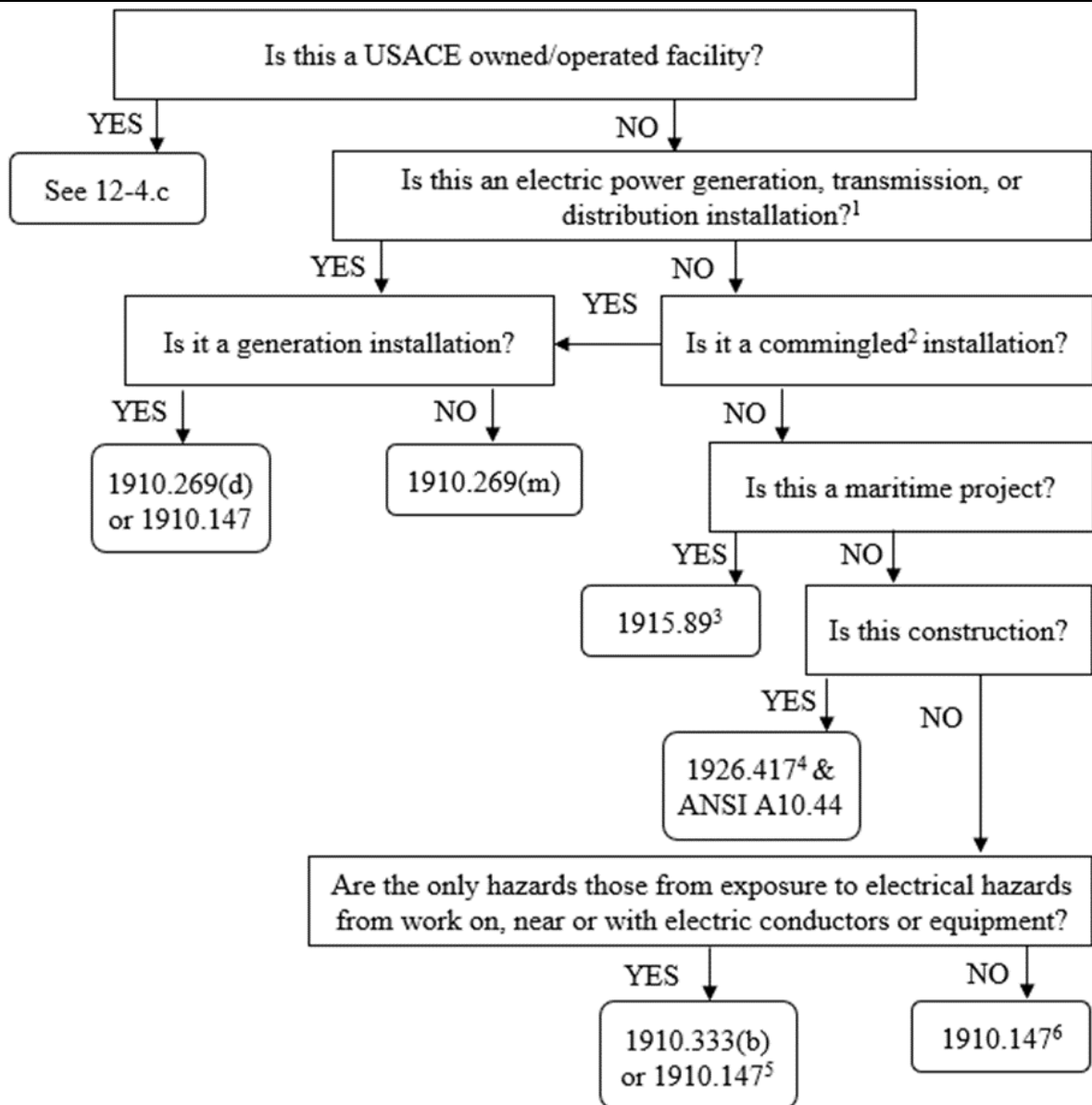

¹ If a generation, transmission, or distribution installation conforms to 29 CFR 1910.302 through 29 CFR 1910.308, the lockout and tagging procedure of 29 CFR 1910.333(b) may be followed for the electric shock hazards.

² This means commingled to the extent that the electric power generation, transmission, or distribution installation poses the greater hazard.

³ For conveyors supplement with 29 CFR 1917.48(i) or 29 CFR 1918.649(k).

⁴ For hazardous chemicals supplement with 29 CFR 1926.64 and 29 CFR 1926.702 for concrete and masonry construction.

⁵ Paragraph (b)(2)(iii)(D) and (b)(2)(iv)(B) or 29 CFR 1910.333 still apply.

⁶ Paragraph (b) of 29 CFR 1910.333 applies to any electrical hazards from work on, near, or with electric conductors and equipment.

Figure 12-1. Application of Relevant Standards to SSEC











Number of Isolation Points: 3		Hazard Isolation Procedure Flux Capacitor		Last Inspection: 26AUG2020 By: Jon Doe	
Location: Building 1					
Purpose: This procedure establishes minimum requirements for the lockout of the Flux Capacitor whenever maintenance or service work is performed. The procedure is used by an Authorized Individual to ensure the machine is stopped, isolated from all potential energy sources, and locked out before any servicing and maintenance.					
<ul style="list-style-type: none"> Prior to starting the lockout procedure, notify all AFFECTED Persons in the work area Bring equipment to a neutral state utilizing normal stopping procedures 					
Energy Type and Source	Isolation Point	Method and Device		Reference	
 Electrical 480V	Breaker 1M at MCC6 in PP1	Move Breaker 1M to the off position. Verify indicator light is dark and attempt to start. Secure Breaker 1M with lock and tag and ensure breaker cannot be moved to "on" position. Time: Initials:			
 Thermal 200C (Residual)	Wait 20+ minutes until heat from flux injectors has dissipated to less than 30C before proceeding	Isolation of Breaker 1M prevents flux from being heated by the flux capacitor. Verify flux temperature on gauge located on the West side of machine before servicing. Time: Initials:			
 Water	Isolation valve is on North side of machine	Turn Valve 1047 to the off position. Verify water has been shut off by checking that flow has stopped at drain on North side of machine. Secure Valve 1047 with lock and tag. Time: Initials:			
 Pneumatic	Isolation valve is on North side of machine	Turn Valve 1096A to the closed position. Verify air pressure has dissipated at the attached gauge. Secure Valve 1096A with lock and tag. Time: Initials:			
 Hydraulic 800psi	Hydraulic pressure will automatically be released when electrical source Breaker 1M is disconnected	Ensure all hydraulic pressure has bleed off by verifying the change in pressure from 800psi to 0psi at the hydraulic relief valve located on the East side of the machine. Time: Initials:			
Stored or residual energy (such as that in capacitors, springs, elevated machine members, rotating flywheels, hydraulic systems, as well as air, gas, steam, or water pressure, etc.) must be dissipated or restrained by methods such as grounding, repositioning, blocking, bleeding down, etc.					
<ol style="list-style-type: none"> Ensure that the equipment is disconnected from the energy sources by first checking that no personnel are exposed, then verify the isolation of the equipment by operating the push button or other normal operating controls or by testing to make certain the equipment will not operate. Return operating controls to the neutral position after verifying the isolation of the equipment. If possible, contact with electrical conductors could occur; Electrically Qualified Person must perform voltage test on all phases of the load side of the circuit to verify absence of voltage. 					
<ol style="list-style-type: none"> Ensure all tools and items have been removed. Confirm that all employees are safely located. Ensure the safety devices and guards are in place. Verify the controls are in the neutral position. Remove lockout devices and re-energize equipment. Notify affected persons of the re-energization. 					
Written by:		Review by:			
Verified Effective by Testing:		By:	Title:	Effective Date:	
Revision	Date	Revised by:	Description		

Figure 12-2. Hazard Isolation Procedure (HIP) Example (non-mandatory)

12-10. Checklists and Forms.

Not Applicable.

Chapter 13

Hand and Power Tools

13-1. References.

- a. ANSI/ASSP A10.3, Safety Requirements for Powder Actuated Fastening Systems (<https://webstore.ansi.org/>) (13-1.a)
- b. ANSI B7.1, Safety Code for the Use, Care and Protection of Abrasive Wheels (<https://webstore.ansi.org/>) (13-1.b)
- c. ANSI/OPEI B175.1/A1, Internal Combustion Engine-Powered Hand-Held Chain Saws - Safety and Environmental Requirements (<https://webstore.ansi.org/>) (13-1.c)
- d. ANSI O1.1, Woodworking Machinery Safety Requirements (<https://webstore.ansi.org/>) (13-1.d)
- e. 29 CFR 1910 Subpart P, Hand and Portable Powered Tools and Other Hand-Held Equipment (<https://www.govinfo.gov/content/pkg/CFR-2020-title29-vol5/pdf/CFR-2020-title29-vol5-part1910-subpartP.pdf>) (13-1.e)
- f. 29 CFR 1926 Subpart I, Tools-Hand and Power (<https://www.govinfo.gov/content/pkg/CFR-2020-title29-vol8/pdf/CFR-2020-title29-vol8-part1926-subpartI.pdf>) (13-1.f)

13-2. Definitions.

- a. Authorized Instructor. One who has been trained, authorized, and provided an authorized instructor's card by the tool manufacturer or by an authorized representative of the tool manufacturer. (13-2.a)
- b. Explosive-Actuated Tool. A tool that uses the expanding gases from a powder load to drive a fastener. Also referred to as a powder-actuated tool. (13-2.b)

13-3. Personnel Required Training/Qualification.

- a. Before using a power tool, personnel must become familiar with the manufacturer's operating instructions for that specific power tool. (13-3.a)
- b. Explosive-Actuated Tools. Only qualified operators may operate explosive-actuated tools. A qualified operator is one who has: (13-3.b)

(1) Been trained by an authorized instructor.

(2) Possesses a qualified operator's card supplied by the manufacturer and issued and signed by both the instructor and the operator.

c. Chainsaws. Train chainsaw operators according to all manufacturer's recommendations, to include at a minimum: (13-3.c)

(1) Use of PPE according to the manufacturer's recommendations and chapter 5.

(2) Proper fueling procedures.

(3) Safe use and handling procedures.

(4) Proper cutting techniques.

(5) Procedures to avoid kickbacks.

(6) Procedures to avoid and react to binding.

13-4. Roles and Responsibilities.

Not Applicable.

13-5. Inspection Requirements.

a. General Hand and Power Tools. Inspect and test hand and power tools before each use to ensure they are in a safe operating condition according to the manufacturer's instructions. Hand and power tools must be in good repair and with all required safety devices installed and properly adjusted. Remove tools from service that have defects that could impair their strength or render them unsafe. (13-5.a)

b. Explosive-Actuated Tools (13-5.b)

(1) Perform daily inspection, cleaning, and testing as recommended by the manufacturer.

(2) Test explosive-actuated tools according to the manufacturer's recommended procedure each day before loading to see that safety devices are in proper working condition.

(3) Inspect, thoroughly clean, and test each explosive-actuated tool every 1,000 fastenings.

13-6. Activity Hazard Analysis (AHA) Requirements.

Develop AHAs according to paragraphs 1-6 or 2-6, as applicable. When using power tools that require guarding, identify the type of guarding and the inspection requirements on the AHA.

13-7. Minimum Plan Requirements.

Not Applicable.

13-8. General Requirements.

a. All hand and power tools must meet the requirements included in this paragraph. (13-8.a)

(1) Use and maintain hand and power tools according to the manufacturer's instructions and recommendations and only for the purpose for which designed. Keep a copy of the manufacturer's instructions and recommendations with the tools.

(2) Use PPE according to chapter 5 of this manual and as specified by the manufacturer.

(3) When work is being performed overhead, secure tools that are not being used or place them in holders.

(4) Do not throw tools or materials from one location to another or from one person to another or drop them to lower levels.

(5) Use only non-sparking tools when in locations where sources of ignition may cause a fire or explosion.

(6) Tools requiring heat treating or redressing must be tempered, formed, dressed, and sharpened by personnel who are experienced in these operations.

(7) Do not use cranks on hand-powered winches or hoists unless the hoists or winches are provided with positive self-locking dogs. Do not use hand wheels with exposed spokes, projecting pins, or knobs.

(8) Do not allow the use or operation of fuel-powered tools inside confined spaces, enclosed spaces, partially enclosed spaces, or buildings unless adequate ventilation is provided to ensure the equipment does not generate a hazardous atmosphere according to chapters 5, 6, and 34 of this manual.

(9) Do not wear loose and frayed clothing, loose long hair, dangling jewelry (including dangling earring, chains, and wrist watches) while working with any power tool.

(10) Guarding.

(a) Ensure guards are in place and functioning properly for all power tools designed to accommodate guards.

(b) Guard the reciprocating, rotating, and moving parts of equipment employees may come in contact with or that otherwise create a hazard.

(11) Anchor or securely clamp floor and bench-mounted power tools to a firm foundation to withstand lateral or vertical movement.

b. Hand Tools. (13-8.b)

(1) Do not use wrenches, including adjustable, pipe, end, and socket wrenches, when jaws are sprung to the point that slippage occurs.

(2) Keep impact tools, such as drift pins, wedges, and chisels, free of mushroomed heads.

(3) Keep the wooden handles of tools free of splinters or cracks and tight in the tool.

c. Electric Power-Operated Tools. (13-8.c)

(1) Power tools must be listed by a NRTL for the specific application for which they are to be used.

(2) Electric power-operated tools must either be of the approved double-insulated type or grounded according to chapter 11.

(3) GFCI protection must be provided for all outlets serving portable electric hand-tools.

(4) Do not use electric cords for hoisting or lowering tools.

(5) Provide an electrical power control on each machine or power tool to make it possible for the operator to cut off the power to the machine or power tool without leaving the point of operation.

(6) On applications where injury to the operator might result if motors were to restart after power failure, make provisions to prevent machines from automatically restarting upon restoration of power.

(7) See paragraph 13-8.h for additional requirements for electrically powered saws.

d. Pneumatic Power Tools. (13-8.d)

(1) Provide a safety lashing at connections between tool and hose and at all quick makeup type connections.

(2) Install and maintain safety clips or retainers on pneumatic impact (that is, percussion) tools to prevent attachments from being accidentally expelled.

(3) Do not exceed the manufacturer's safe operating pressure for tools, hoses, pipes, valves, filters, and other fittings.

(4) All hoses exceeding one-half ($\frac{1}{2}$) inch (1.3 cm) inside diameter must have a safety device at the source of supply or branch line to reduce pressure in case of hose failure.

(5) Shut off the pressure and exhaust the line before disconnecting the line from any tool or connection.

(6) Do not use hoses to hoist or lower tools.

(7) Equip airless spray guns of the type which atomize paints and fluids at high pressures (that is, 1,000 psi (6,895 kPa) or more) with an automatic or visible, manual safety device. The safety device must prevent the trigger from being pulled so that paint or fluid is not discharged until the safety device is manually released. In lieu of the above, a diffuser nut that will prevent high-pressure velocity release while the nozzle tip is removed plus a nozzle tip guard that will prevent the tip from coming into contact with the operator, or other equivalent protection may be provided.

(8) Provide impact wrenches with a locking device for retaining the socket.

(9) All pneumatic tools used on or around energized lines or equipment must have non-conducting hoses of adequate strength for the normal operating pressures.

e. Hydraulic Power Tools. (13-8.e)

(1) Use appropriate hydraulic fluid in powered tools so that it retains its operating characteristics at the most extreme temperatures to which it will be exposed. For underground use, see chapter 26.

(2) Do not exceed the manufacturers' safe operating pressures for hydraulic hoses, valves, pipes, filters, and other fittings.

(3) All hydraulic tools used on or around energized lines or equipment must have non-conducting hoses of adequate strength for the normal operating pressures.

f. Explosive-Actuated Tools. (13-8.f)

(1) Explosive-actuated (that is, powder-actuated) tools must meet the design requirements of ANSI A10.3.

(2) Provide each tool with the following:

(a) A lockable container with the words "EXPLOSIVE- ACTUATED TOOL" in plain sight on the outside and a notice reading, "WARNING – EXPLOSIVE -ACTUATED TOOL TO BE USED ONLY BY A QUALIFIED OPERATOR AND KEPT UNDER LOCK AND KEY WHEN NOT IN USE" on the inside.

(b) Operator's instruction and service manual.

(c) Power load and fastener charts.

(d) Tool inspection record.

(e) Service tools and accessories.

(3) Secure explosive-actuated tools and the charges at all times to prevent unauthorized possession or use.

(4) Do not load explosive-actuated tools until just before the intended firing time. Do not point load nor empty tools in the direction of other persons. Keep hands clear of the open barrel end.

(5) Do not use explosive-actuated tools in explosive or flammable atmospheres.

(6) Do not drive fasteners into:

(a) Soft or easily penetrable materials, unless they are backed by a material that will prevent the fastener from passing through to the other side.

(b) Very hard or brittle material such as cast iron, hardened steel, glazed or hollow tile, glass block, brick, or rock.

(c) Concrete, unless the material thickness is at least three times the penetration of the fastener shank.

(d) Spalled concrete.

(7) If the explosive-actuated tool misfires, wait at least 30 seconds before firing again. If the tool will not fire after a second attempt, wait at least another 30 seconds before removing the faulty cartridge. Place the faulty cartridge in water until disposal. Follow the manufacturer's instructions for appropriate disposal.

g. Grinding and Abrasive Machinery. (13-8.g)

(1) Equip all abrasive wheels and tools with safety guards and comply with other applicable requirements of ANSI B7.1.

(2) With the exception of the following, use abrasive wheels only on machines provided with safety guards.

(a) Portable abrasive wheels used for internal grinding if the wheel is entirely within the work being ground.

(b) Portable abrasive wheels used for internal grinding when wheels 2 inches (5.1 cm) or less in diameter are securely mounted on the end of a steel mandrel.

(c) Types 16, 17, 18, 18R, and 19 cones and plugs and threaded hole pot balls, where the work offers protection or where the size does not exceed 3 inches (7.6 cm) in diameter by 5 inches (12.7 cm) long.

(d) Type 1 wheels not larger than 2 inches (5 cm) in diameter and not more than one-half ($\frac{1}{2}$) inch (1.2 cm) thick, operated at peripheral speeds less than 1800 surface-feet per minute (ft/min) (9.1 surface-m/s) when mounted in mandrels driven by portable drills.

(e) Type 1 reinforced wheels not more than 3 inches (7.6 cm) in diameter and one-quarter ($\frac{1}{4}$) inch (0.6 cm) in thickness, operating at peripheral speeds not exceeding 9500 surface-feet/min (48.3 surface-m/s) if safety glasses and face shield protection are worn.

(3) Adjust tongue guards on bench/stand grinders to within one-quarter ($\frac{1}{4}$) inch (0.6 cm) of the constantly decreasing diameter of the wheel at the upper opening.

(4) Supply grinders with power sufficient to maintain the spindle speed at safe levels under all conditions of normal operation.

(5) Do not adjust work or tool rests while the grinding wheel is in motion.

(6) Position work or tool rests on power grinders within one-eighth ($\frac{1}{8}$) inch (0.3 cm) from the wheel.

(7) Closely inspect abrasive wheels and ring-test them before mounting. Destroy cracked or damaged grinding wheels.

(8) Do not operate grinding wheels in excess of their rated safe speed.

(9) Provide floor stand and bench-mounted abrasive wheels used for external grinding with safety guards (for example, protective hoods).

(a) Maintain the maximum angular exposure of the grinding wheel periphery and sides to not more than 90°, except when work requires contact with the wheel below the horizontal plane of the spindle, in which case, maintain the angular exposure to not more than 125°. In all situations, maintain the angular exposure to not more than 65° above the horizontal plane of the spindle.

(b) Safety guards must be strong enough to withstand the effect of a bursting wheel.

h. Power Saws and Woodworking Machinery. (13-8.h)

(1) Operate and maintain woodworking machinery according to ANSI O1.1.

(2) Guarding.

(a) Ensure hand-fed circular saws are equipped with guards that automatically and completely enclose the cutting edges, splitters, and anti-kickback devices.

(b) Ensure portable power-driven circular saws are equipped with guards above and below the base plate or shoe.

(b-1) The upper and lower guards must cover the saw to the depth of the teeth, except for the minimum arc required to permit the base to be tilted for bevel cuts and for the minimum arc required to allow proper retraction and contact with the work, respectively.

(b-2) When the tool is withdrawn from the work, the lower guard must automatically and instantly return to the covering position.

(c) Fully guard the blades of planers and jointers and equip them with cylindrical heads with throats in the cylinder.

(d) Fully enclose band saw blades except at the point of operation.

(3) Install automatic feeding devices on machines whenever possible. Cover or guard feed rolls and other moving parts on feeder attachments to protect the operator from hazardous points.

(4) Permanently mark the operating speed on circular saws more than 20 inches (50.8 cm) in diameter or operating at over 10,000 peripheral feet/min (50.8 peripheral m/s).

(a) Do not operate saws at a speed other than that marked on the blade.

(b) When a marked saw is re-tensioned for a different speed, correct the marking to show the new speed.

(5) Equip radial arm power saws with an automatic brake.

(6) The table of radial arm or swing saws must extend beyond the leading edge of the saw blade.

(7) Install radial arm power saws so the cutting head will return to the starting position when released by the operator. Equip all swing cutoff and radial saws or similar machines drawn across a table with limit stops to prevent the leading edge of the tool from traveling beyond the edge of the table.

(8) Each hand-fed crosscut table saw and each hand-fed circular ripsaw must have a spreader to prevent the material from squeezing the saw or being thrown back on the operator.

(9) Warm-up band saws and other machinery requiring minimum ambient temperatures for safe operation prior to using them to perform their intended operation. Warm up machinery whenever the temperature is below 45°F (7°C).

(10) Use a push-stick, block, or other safe means on all operations close to high-speed cutting edges.

(11) Do not use cracked, bent, or otherwise defective parts such as saw blades, cutters, or knives.

(12) Provide a brush for the removal of sawdust, chips, and shavings on all woodworking machinery.

(13) Do not leave power saws running unattended.

i. Chainsaws. (13-8.i)

(1) Chainsaws must have a clutch, automatic chain brake (gas only) or kickback device, throttle trigger latch, stop switch, rear hand guard, chain catcher, vibration damper, spark arrestor, and muffler, and must otherwise meet the requirements of ANSI/OPEI B175.1/A1.

(2) Gas-powered chainsaws must be equipped with a control that will return the saw to idling speed when released.

(3) Start and operate chainsaws only after all co-workers are clear and then according to the manufacturer's instructions.

(4) Start chainsaws on the ground or where otherwise firmly supported. Do not drop start a chainsaw.

(5) Start chainsaws with the chain brake engaged.

(6) Adjust the idle speed so that the chain does not move when the engine is idling.

(7) Do not fuel chainsaws while running, while hot, or near an open flame. Do not start saws within 10 feet (3 m) of a fuel container.

(8) The operator must hold the saw with both hands during all cutting operations.

(9) Shut off the saw when carrying it over slippery surfaces, through heavy brush, and when adjacent to others. The saw may be carried running at idle speed with the brake set for short distances (less than 50 feet (15.2 m)) as long as it is carried to prevent contact with the chain or muffler.

(10) Never use a chainsaw to cut above the operators' shoulder height.

(11) Keep chainsaw chains sharp and properly adjusted according to the manufacturer's instructions.

(12) See chapter 31 for tree maintenance and removal requirements.

j. Abrasive Blasting Equipment. (13-8.j)

(1) Hose and hose connections must be designed to prevent build-up of static electricity.

(2) Connections and nozzles must be designed to prevent accidental disengagement. Equip all connections with safety lashings. (See chapter 20)

(3) Nozzle attachments must be of metal and fit on the outside of the hose. Provide a deadman-type control device at the nozzle to cut off the flow if the operator loses control of the hose. Provide a support on which the nozzle may be mounted when it is not in use.

(4) Refer to chapter 6 for additional requirements on abrasive blasting.

k. Power-Driven Nailers and Staplers. This subparagraph applies to hand-held electric, combustion, or pneumatically driven nailers, staplers, and other similar equipment (referred to as "nailers" in this subparagraph) which operate by ejecting a fastener into the material to be fastened when a trigger, lever, or other manual device is actuated. This does not apply to common spring-loaded "staple guns". (13-8.k)

(1) Nailers must have a safety device on the muzzle to prevent the tool from ejecting fasteners unless the muzzle is in contact with the work surface. Do not secure the contact trip device or trigger in an "on" position.

(2) Operate nailers in a way that minimizes the danger to others and the operator from ricochets, air-firing, and firing through materials being fastened.

(a) Except when used for attaching sheet goods (for example, sheathing, sub-flooring, plywood) or roofing products, only operate nailers with a sequential trigger system that requires that the surface contact trip device be depressed before the firing trigger can be activated and that limits ejection to one nail per trigger pull before resetting.

(b) When used for sheet goods and roofing materials, nailers may be operated in the contact trip mode (that is, bump or bounce-nailing) only as allowed by the manufacturer. This mode may only be used when the operator has secure footing, such as on a work platform, floor, or deck, and may not be used when the operator is on a ladder, beam, or similar situations where the operator's balance or reach may be unstable.

(3) When clearing a nail jam or performing maintenance on the nailer, disconnect the power source (for example, air hose, plug, battery).

I. Jacks - Lever and Ratchet, Screw, and Hydraulic. (13-8.I)

(1) Legibly mark the manufacturer's rated capacity on all jacks and do not exceed.

(2) All jacks must have a positive stop to prevent over-travel.

(3) After the load has been raised, immediately crib, block, or otherwise secure.

(4) Tag jacks which are out of order and do not use until repairs are made.

(5) For additional requirement specific to jacks, see 29 CFR 1926.305 (29 CFR 1926 Subpart I).

13-9. Figures and Tables.

Not Applicable.

13-10. Checklists and Forms.

Not Applicable.

Chapter 14

Material Handling, Storage, Disposal, and Conveyors

14-1. References.

a. ANSI/ASSP A10.5, Safety Requirements for Material Hoists
(<https://webstore.ansi.org>) (14-1.a)

- b. ANSI/UL 1313, Standard for Nonmetallic Safety Cans for Petroleum Products (<https://www.shopulstandards.com/Default.aspx>) (14-1.b)
- c. ASME B20.1, Safety Standards for Conveyors and Related Equipment (<https://www.asme.org/>) (14-1.c)
- d. ASTM F852/F852M, Standard Specification for Portable Gasoline, Kerosene, and Diesel Containers for Consumer Use (<https://www.astm.org/Standard/standards-and-publications.html>) (14-1.d)
- e. National Motor Freight Traffic Association (NMFTA)/National Motor Freight Classification (NMFC) Item 296 (<https://nmfta.org/>) (14-1.e)
- f. NIOSH 81-122, Work Practices Guide for Manual Lifting (<https://www.cdc.gov/niosh/docs/81-122/default.html>) (14-1.f)
- g. NFPA 30, Flammable and Combustible Liquids Code (<https://www.nfpa.org/Codes-and-Standards>) (14-1.g)
- h. NFPA 30A, Code for Motor Fuel Dispensing Facilities and Repair Garages (<https://www.nfpa.org/Codes-and-Standards>) (14-1.h)
- i. NFPA 58, Liquefied Petroleum Gas Code (<https://www.nfpa.org/Codes-and-Standards>) (14-1.i)
- j. NFPA 70, National Electrical Code (<https://www.nfpa.org/Codes-and-Standards>) (14-1.j)
- k. UFC 6000-M, National Railroad Freight Committee, Agent (<https://public.railinc.com/resources/national-tariffs/ufc-6000-m>) (14-1.k)
- l. United Nations Recommendations on the Transport of Dangerous Goods: Model Regulations - Twenty-Second Revised Edition, Chapter 9 (<https://shop.un.org>) (14-1.l)
- m. 29 CFR 1910.106, Flammable Liquids (<https://www.govinfo.gov/content/pkg/CFR-2020-title29-vol5/pdf/CFR-2020-title29-vol5-sec1910-106.pdf>) (14-1.m)
- n. 29 CFR 1910.110, Storage and Handling of Liquefied Petroleum Gases (<https://www.govinfo.gov/content/pkg/CFR-2019-title29-vol5/pdf/CFR-2019-title29-vol5-sec1910-110.pdf>) (14-1.n)
- o. 29 CFR 1926.152, Flammable Liquids (<https://www.govinfo.gov/content/pkg/CFR-2020-title29-vol8/pdf/CFR-2020-title29-vol8-sec1926-152.pdf>) (14-1.o)

- p. 29 CFR 1926.153, Liquefied Petroleum Gas
(<https://www.govinfo.gov/content/pkg/CFR-2020-title29-vol8/pdf/CFR-2020-title29-vol8-sec1926-153.pdf>) (14-1.p)
- q. 29 CFR 1926.555, Conveyors (<https://www.govinfo.gov/content/pkg/CFR-2020-title29-vol8/pdf/CFR-2020-title29-vol8-sec1926-555.pdf>) (14-1.q)
- r. 40 CFR 112, Oil Pollution Prevention
(<https://www.govinfo.gov/content/pkg/CFR-2019-title40-vol24/pdf/CFR-2019-title40-vol24-part112.pdf>) (14-1.r)
- s. 46 CFR 92.05-10, Lamp Room Construction
(<https://www.govinfo.gov/content/pkg/CFR-2019-title46-vol4/pdf/CFR-2019-title46-vol4-sec92-05-10.pdf>) (14-1.s)
- t. 46 CFR 147, Hazardous Ships' Stores
(<https://www.govinfo.gov/content/pkg/CFR-2019-title46-vol5/pdf/CFR-2019-title46-vol5-part147.pdf>) (14-1.t)
- u. 49 CFR Chapter I, Pipeline and Hazardous Materials Safety Administration, Department of Transportation
(<https://www.govinfo.gov/app/collection/cfr/2019/title49/subtitleB/chapterI>) (14-1.u)

14-2. Definitions.

- a. Competent Person (CP). See paragraphs 1-2 or 2-2, as applicable. (14-2.a)
- b. Contaminant. Any material, that, by nature of its composition or reaction with other materials, is potentially capable of causing injury, death, illness, damage, loss, or pain. (14-2.b)
- c. Debris Net. A net designed to catch only debris. It must be used in conjunction with a personnel net if there is any possibility for personnel to fall. (14-2.c)
- d. Flammable Liquid. Any liquid having a flashpoint at or below 199.4°F (93°C). Flammable liquids are divided into four categories as follows: (14-2.d)
- (1) Category 1 includes liquids having flashpoints below 73.4°F (23°C) and having a boiling point at or below 95°F (35°C).
- (2) Category 2 includes liquids having flashpoints below 73.4°F (23°C) and having a boiling point above 95°F (35°C).
- (3) Category 3 includes liquids having flashpoints at or above 73.4°F (23°C) and at or below 140°F (60°C).

(4) Category 4 includes liquids having flashpoints above 140°F (60°C) and at or below 199.4°F (93°C).

e. Hoist. A machinery unit that is used for lifting or lowering a freely suspended (unguided) load. (14-2.e)

f. Identified (as applied to equipment, for example, containers, portable fire extinguishers). Recognizable as suitable for the specific purpose, function, use, environment, application, etc., where described in a particular code requirement. Suitability of equipment for a specific purpose, environment, or application may be decided by a qualified testing laboratory, inspection agency, or other organization concerned with product evaluation. Such identification may include labeling or listing. See definitions of Labeled and Listed. (14-2.f)

g. Labeled. Equipment or material that has an attached label, symbol, or other identifying mark of an organization that is acceptable to the AHJ and concerned with the product evaluation that maintains periodic inspection of production of labeled equipment or materials and by whose labeling the manufacturer indicates compliance with appropriate standards or performance in a specified manner. (14-2.g)

h. Liquefied Petroleum Gas (LP-Gas). Any material that is composed predominantly of any of the following hydrocarbons or mixtures of them: propane, propylene, butanes, or butylenes. (14-2.h)

i. Listed. Equipment, materials, or services included in a list published by an organization acceptable to the AHJ and concerned with the evaluation of products or services that maintains periodic inspection of production of listed equipment or materials or periodic evaluation of services and whose listing states either that the equipment, material, or service meets identified standards or has been tested and found suitable for a specified purpose. (14-2.i)

j. Qualified Person (QP). See paragraphs 1-2 or 2-2, as applicable. (14-2.j)

k. Safety Can. An approved container, of not more than 5-gal (18.9 L) capacity, having a spring-closing lid and spout cover and designed to safety relieve internal pressures under fire exposure. An approved container is one that has been listed or approved by a NRTL such as Factory Mutual Engineering Corp., or UL, or federal agencies such as Bureau of Mines or USCG, which issue approvals for such equipment. (14-2.k)

l. Storage Tank. Any vessel having a liquid capacity that exceeds 60 gal (227.1 L), is intended for fixed installation, and is not used for processing. (14-2.l)

14-3. Personnel Required Qualification/Training.

a. Safe Lifting. Train employees on safe lifting techniques (see para 6-8.o). (14-3.a)

b. Conveyors. Train personnel that perform adjustments, maintenance, or lubrication on conveyors that are operating and in motion on the hazards associated with the conveyor. (14-3.b)

14-4. Roles and Responsibilities.

a. Registered Professional Engineer (RPE). An RPE (see paras 1-2 or 2-2, as applicable) must design material hoist towers, masts, guy or braces, counterweights, drive machinery supports, sheave supports, platforms, supporting structures, and accessories. (14-4.a)

b. Hoist Operator. While hoisting equipment is in operation, the operator may not perform any other work and must constantly tend the controls until the load has been safely landed or returned to ground level. (14-4.b)

c. Competent Person (CP). A CP must determine and document the size, weight, and height of fall or potential falling debris, and select debris netting with mesh of the size and strength sufficient to contain the expected debris without penetration when properly supported. (14-4.c)

d. Qualified Person (QP). (14-4.d)

(1) A QP must perform inspections of material hoists according to paragraph 14-5.b.

(2) A QP must supervise all storage, handling, and use of flammable liquids to ensure conformance to 29 CFR 1910.106, 29 CFR 1926.152, NFPA 30, and NFPA 30A (see para 14-8.b).

(3) A QP must supervise the erection and dismantling of all hoist towers.

14-5. Inspection Requirements.

a. General. Inspect storage systems (for example, racking, shelving, blocking), packaging (for example, containers, pallets, boxes), and their components (for example, hoses, couplings) according to the manufacturer's instructions to ensure they are in serviceable condition and capable of supporting the capacity and/or containing the material being stored. Remove from service and repair or discard any system and/or its components showing material deteriorations, signs of leakage, or weakness. (14-5.a)

b. Material Hoists. (14-5.b)

(1) Inspect and test material hoists and hoist tower systems according to the manufacturer's instructions and ANSI/ASSP A10.5.

(2) Prior to initial use and each time after the tower is extended or modified, a QP must perform a functionality test and inspect all parts of the tower or mast, cage, bucket, boom, platform, hoisting machine, guy, and other associated equipment, to ensure compliance with the manufacturer's inspection guidelines and ANSI/ASSP A10.5.

(3) A QP must perform monthly inspections. Maintain records of monthly inspection onsite and make them available upon request of the local SOHO/USACE supervisor/KO or COR.

(4) The operator must conduct pre-operational inspections (for example, start-up procedures) prior to every operation (for example, shift, relocation) of the hoist.

(5) The local SOHO/USACE supervisor/KO or COR must be notified at least 24 hours prior to any of the above inspections.

c. Housekeeping. Inspect work areas daily for adequate housekeeping and record the findings in daily inspection reports. (14-5.c)

d. Flammable Liquids. (14-5.d)

(1) Inspect dispensing hoses according to the manufacturer's instructions. At a minimum, hoses that display any of the following are an indication of permanent damage and must be replaced immediately:

(a) Cuts, abrasions, or cracks in the cover that penetrates to the reinforcement.

(b) Blistering or loose cover.

(c) Soft spots, particularly adjacent to the coupling.

(d) Indication of coupling slippage or irregular coupling alignment.

(e) Flattening or kinking resulting in permanent deformation.

(2) Inspect storage tanks containing flammable liquids according to NFPA 30.

14-6. Activity Hazard Analysis (AHA) Requirements.

Develop AHAs according to paragraphs 1-6 or 2-6, as applicable.

14-7. Minimum Plan Requirements.

Not Applicable.

14-8. General Requirements.

a. Material Handling. (14-8.a)

(1) See chapter 5 for PPE requirements.

(2) Make available and use, according to the manufacturer's instructions, material handling devices (for example, lift truck, overhead crane, conveyor, jacks) for the material handling needs of an activity.

(3) Evaluate material handling needs in terms of weight, size, distance, and path of movement whenever heavy or bulky material is to be moved. Use the following hierarchy, starting with the most preferred, when selecting a means for material handling:

(a) Use engineering solutions to eliminate material handling needs.

(b) Use mechanical devices.

(c) Use manual means with handling aid (for example, dolly, cart).

(d) Use safe lifting techniques (see para 6-8.o and NIOSH 81-122).

(4) Do not move materials over or suspend them above personnel unless positive precautions have been taken to protect the personnel from falling objects.

(5) Use taglines or other devices to control the load when the movement of hoisted materials may be hazardous to persons. Use only nonconductive devices near energized lines.

(6) Do not use banding or strapping as a means of rigging to hoist loads of bundled materials.

(7) Ensure that all persons are in a safe position while materials are being loaded or unloaded from railroad cars, trucks, or barges.

(8) Material Hoists.

(a) Design, construct, and install material hoists to raise and lower materials during construction, alteration, or demolition according to ANSI A10.5.

Note. ANSI A10.5 is not applicable to the temporary use of permanently installed elevators used as material hoists.

(b) Make available a copy of the hoist operating manual for each onsite hoist.

(c) Maintenance and Repairs.

(c-1) Replacement parts for load bearing or critical components must be obtained from or certified by the equipment manufacturer.

(c-2) Conduct maintenance and repairs according to the manufacturer's instructions.

(d) Landings and Runways.

(d-1) Landing platforms and runways that connect the hoist way or tower to a structure must be designed and constructed to sustain the maximum intended load without failure.

(d-2) Floors or platforms that may become slippery must have slip-resistant surfaces.

(d-3) Provide overhead protection, composed of 2 inches (5 cm) planking or equivalent, when workers may be exposed to falling objects.

(d-4) Provide a barricade at the open ends of each landing. The barricade must extend a minimum distance of 6 feet (1.8 m) laterally along the outer edge of the landing from each side of the hoist way and extend from the floor a distance of at least 3 feet (0.9 m). It must be constructed of #19 US gauge wire or the equivalent, with openings not exceeding one-half ($\frac{1}{2}$) inch (1.3 cm).

(d-5) Protect hoist way entrances by substantial gates or bars that guard the full width of the landing entrance. Gates must be no less than 66 inches (167.6 cm) in height, have a maximum under clearance of 2 inches (5.1 cm), and be located no more than 4 inches (10.2 cm) from the hoist way line. Gates composed of grille, lattice, or other open work must not have openings of more than 2 inches (5 cm).

(d-6) Do not store material on landing platforms or runways.

(e) Whenever a slack line condition occurs, check the proper seating of the rope in the sheaves and on the drum prior to further operations.

(f) Do not ride on material hoists or other hoisting equipment not meant for personnel handling.

(g) Do not operate more than one cage or bucket at the same time by any one hoisting machine or operator.

(h) Establish operating rules and post them at the operator's station of the hoist. Rules must include signal system and allowable line speed for various loads.

(i) Post rules and notices on the car frame or crosshead in a conspicuous location and include the statement "NO RIDERS ALLOWED."

(j) Connect air-powered hoists to an air supply of sufficient capacity and pressure to safely operate the hoist. Secure pneumatic hoses by some positive means to prevent accidental disconnection.

(9) Conveyors.

(a) Construct and install conveyor and hauling systems according to the manufacturer's instructions.

(b) Provide safe access to permit inspection, lubrication, repair, and maintenance activities.

(c) Properly ground conveyors before use. All connections, switches, and cables must conform to NFPA 70.

(d) Do not perform maintenance while a conveyor is in operation unless personnel are trained on the associated hazards (see para 14-3.b).

(e) Use HEC procedures for maintenance and servicing activities other than routine lubrication which is done without removing guards (see chapter 12).

(f) Safety Devices.

(f-1) Install anti-runaway devices, brakes, backstops, or other safeguards on all conveyors where reversing or runaway are potential hazards, or the effects of gravity create a potential for hazardous uncontrolled lowering.

(f-2) Design safety devices to prevent the conveyor from automatically restarting until the safety device has been manually reset.

(f-3) Arrange safety devices to operate in such a manner that if power failure or a mechanical failure of the device occurs a hazardous condition will not result.

(f-4) Equip conveyor systems with a time-delay audible and visual warning signal to be sounded immediately before starting of the conveyor.

(f-5) Warning devices must be clearly audible at all points along the conveyor where personnel may be present.

(f-6) Warning devices must be activated by the controller device that starts the conveyor and must continue for a period before the conveyor starts.

(f-7) For overland conveyor systems, warning devices are required only at the transfer, loading, and discharge points and those points where personnel are normally stationed.

(f-8) In areas not exposed to the public, provide clear, concise, and legible warning signs that indicate the conveyor system may start at any time if the function of the system would be seriously hindered or adversely affected by the required time delay, or if the intent of the warning may be misinterpreted. These warning signs must say that danger exists, the conveyor may start without warning and personnel must keep clear. Post warnings signs along the conveyor in all areas that are not guarded or otherwise protected by their location.

(g) Mechanically guard or guard by location all exposed moving machinery parts that present a hazard.

(g-1) Guard all nip and shear points.

(g-2) Provide guards at points where personnel could contact cables, chains, belts, and runaways of exposed bucket conveyors.

(g-3) When lubricating while the conveyor is in motion, lubrication points must be accessible through guard openings that prevent fingers or other small tools from reaching the hazardous locations.

(g-4) If guards need to be removed for adjustment or maintenance of the conveyor, use HEC procedures prior to removing the guards according to chapter 12.

(g-5) In lieu of guarding individual nip and shear points, take-up mechanisms may be guarded by placing standard railings, or fencing and warning signs, around the area.

(g-6) In the case of a trolley conveyor when mechanical or electrical guarding would render the conveyor unusable, conspicuously post prominent, and legible warnings in the area or on the equipment. Additionally, where feasible, place barricades or mark lines on the ground to indicate the hazard area.

(g-7) Unless guarded by location, provide sections of chain conveyors that cannot be enclosed without impairing the function with warning signs or personnel barriers.

(g-8) Provide conveyors with spill guards, pan guards, or the equivalent if there is a potential for material to fall off the conveyor and endanger personnel or equipment.

(g-9) At transfer, loading, and discharge points, prevent unconfined and uncontrolled free fall of material if the material would create a hazard to personnel.

Free fall of material can result from flooding, ricocheting, overloading, trajectory, leakage, or a combination thereof.

(g-10) In the absence of a guard specifically erected to protect personnel, provide warnings to restrict unauthorized personnel from entering such hazardous areas.

(g-11) At all points along the conveyor, except where loads are removed from or placed on a conveyor or where a conveyor discharges to or receives material from another conveyor, make provisions to eliminate the possibility of loads or material being dislodged from the conveyor.

(g-12) Remove build-up of excess material from all points along the conveyor.

(h) Access.

(h-1) Provide crossovers or underpasses with safeguards for passage over or under all conveyors. Do not cross over or under conveyors except where safe passageways are provided.

(h-2) Install protective guards whenever conveyors pass next to, or over, work areas, roadways, highways, railroads, or other public passageways. The guards must be designed to catch and hold any load or material that may fall off or become dislodged from the system.

(h-3) Where conveyors are operated in tunnels, pits, and similar enclosures, provide ample room for safe access and operating space for all personnel.

(i) Operating Controls.

(i-1) Provide emergency stop buttons, pull cords, limit switches, or similar emergency devices at the following locations unless the design, construction, and operation of a conveyor is determined to be non-hazardous to personnel: operator stations, loading arms, transfer points, and other potentially hazardous locations on the conveyor path not otherwise protected.

(i-2) Emergency stop buttons must be RED in color, easily identifiable, and readily accessible. Do not protect them with collars or other devices that could affect their operation during an emergency.

(i-3) Emergency stop devices must act directly on the control of the conveyor concerned and may not depend on the stopping of any other equipment. For a multi-conveyor system, the emergency stop must stop all conveyors that are tied together.

(i-4) Install emergency stop devices so that they cannot be overridden from other locations.

(i-5) Starting controls must be GREEN in color and be protected from accidental activation.

(i-6) Clearly label all controls to identify their function.

(i-7) Arrange conveyor controls so that in case of an emergency stop the conveyor operations will not resume until the operator has manually reset or restarted the conveyor at the location where the emergency stop was initiated.

(i-8) Arrange and locate control stations so that the operation of the equipment is visible from them.

(j) Gates and Switches.

(j-1) Provide power-positioned gate and switch sections with devices that will prevent these sections from falling in case of power failure.

(j-2) Provide means on all gates and switch sections to prevent conveyed material from discharging into the open area created when lifting the gate or switch.

(k) Counterweights.

(k-1) Confine counterweights supported by belts, cables, chains, or similar means, inside an enclosure to prevent injury to personnel or include an arrangement that will restrain the falling weight in case of failure of the normal counterweight support.

(k-2) Securely fasten counterweights attached to lever arms.

(l) When two or more conveying systems are interfaced, the interfaced areas must contain adequate guarding and safety devices.

(m) Hoppers and Chutes.

(m-1) Guard all openings to the hopper and chutes to prevent persons from accidentally stepping into them. If guards are not practical, conspicuously post warning signs.

(m-2) Equip dump hoppers that have a hopper flush with the floor and cannot be guarded with grating having a maximum opening of 4 inches (10.2 cm) and heavy enough to withstand any load imposed on it. If the openings in the grating are larger or if no grating is provided, place temporary railing around ground level hoppers when dumping operation are not in progress. During dumping operation, place warning signs in conspicuous locations warning personnel of an open pit.

(n) Mobile Conveyors.

(n-1) Provide mobile conveyors with brakes or other position locking devices where movement would present a hazard.

(n-2) Design mobile conveyors to prevent runaway and remain stable against overturning under normal conditions of operation.

(n-3) When an operator is required on a mobile conveyor, provide a platform or cab for their protection.

(o) Portable Conveyors.

(o-1) Provide portable conveyors with a safety device on the raising and lowering mechanism of the boom to hold the boom at any rated angle of inclination.

(o-2) Portable conveyors must be stable so that the conveyor will not topple when used within the manufacturer's rating and in a manner in which it was intended or when being moved.

(p) Screw Conveyors.

(p-1) Do not operate the screw conveyor unless the conveyor housing completely encloses the conveyor's moving elements and the power transmission guards are in place. If the conveyor must have an open housing as a condition of use, then guard the entire conveyor by railing, fence, or by location.

(p-2) Construct feed openings for shovel, front-end loader, or other manual or mechanical equipment so that the conveyor screw is always covered by grating. If grating cannot be used, guard the exposed section of the conveyor by a railing and conspicuously post warning signs.

(q) Operation.

(q-1) Use conveyors only for materials for which it was designed and within the rated capacities and speeds.

(q-2) At installation of flight and apron conveyors, "jog" or hand run through at least one complete revolution to check design clearances prior to running under automatic power.

(q-3) Before restarting a conveyor that has been stopped because of an emergency, conduct an inspection of the conveyor, determine the cause of the emergency stop, and make corrections.

(q-4) Keep the area around loading and unloading points clear of obstructions that could create a hazard.

(q-5) Maintain rotating drive pulleys and conveyor belts according to the manufacturer's instructions.

(q-6) Clean the conveyors as often as required to ensure safe operation.

b. Material Storage. (14-8.b)

(1) Stack, block, interlock, and limit in height all material in bags, containers, bundles, or stored in tiers so that it is stable and secured against sliding or collapse.

(a) Stack material as low as practical and in no case higher than 20 feet (6.1 m) unless otherwise specified in this chapter.

(b) Store hazardous and toxic agents according to chapter 6.

(c) Store compressed gas cylinders according to chapter 20.

(2) Adequately cover or store indoors material that could become damaged or affected by exposure to the elements.

(3) Do not store materials in areas that would interfere with other normal operations.

(4) Do not store materials directly under power lines unless safe clearance or distance from all materials to the power line is achieved. Document this situation in an AHA. (See chapter 11)

(5) Store materials according to the manufacturer's recommended method of storage.

(6) Do not place materials stored inside buildings under construction within 6 feet (1.8 m) of any hoist-way or floor opening, or within 10 feet (3 m) of an exterior wall that does not extend above the materials stored.

(7) Keep all stairways, passageways, gangways, and accessways free of materials, supplies, and obstructions at all times.

(8) Unauthorized persons are not permitted to enter storage areas. Ensure that everyone is in a safe position while materials are being loaded or unloaded from railroad cars, trucks, or barges.

(9) Do not store material on scaffolds, work platforms, or runways in excess of the load limits (see chapters 24 and 22).

(10) Evaluate the containers, bins, or hoppers used for material storage to ensure that they comply with the confined space requirements of chapter 34.

(11) Segregate noncompatible stored materials.

(12) Do not store flammable or combustible materials in areas where there is danger of underground fire.

(13) When not in use, store paint-soiled clothing and drop cloths in well-ventilated steel cabinets or containers.

(14) Cover temporary enclosures with flame-resistant tarpaulins or material of equivalent fire-resistant characteristics.

(15) Storage of Lumber.

(a) During construction, store lumber in sections that contain no more than one million board feet and locate them at least 10 feet (3 m) away from buildings.

(b) Support lumber on stable sills and stack it level, stable, and self-supporting.

(c) Remove all nails from reusable lumber before stacking it for storage.

(d) Do not pile lumber more than 20 feet (6.1 m) in height. Do not stack manually handled lumber more than 16 feet (4.9 m) high.

(16) Storage of Bagged Materials.

(a) Stack bagged materials by stepping back the layers and cross keying the bags at least every 10 bags high.

(b) Do not stack bags of cement or lime more than 10 high without setback, except when restrained by walls of appropriate strength.

(c) Place bags around the outside of the stack with their openings facing the center of the stack.

(d) During unstacking, keep the top of the stack nearly level and maintain the necessary setback.

(17) Storage of Brick.

(a) Stack bricks on an even, solid surface.

(b) Do not stack bricks more than 7 feet (2.1 m) high. When stacked loose brick reaches a height of 4 feet (1.2 m), taper it back 2 inches (5.1 cm) for every 1-foot (0.3 m) of height above the 4 feet (1.2 m) level.

(c) Do not stack unitized brick (that is, brick securely gathered into large standard packages and fastened with straps) more than three units high.

(18) Storage of Floor, Wall, and Partition Block.

(a) Stack blocks in tiers on solid, level surfaces.

(b) When masonry blocks are stacked higher than 6 feet (1.8 m), taper back the one-half block per tier above the 6 feet (1.8 m) level.

(19) Storage of Reinforcing and Structural Steel.

(a) Store reinforcing steel in orderly piles away from walkways and roadways.

(b) Securely pile structural steel to prevent members sliding off or the pile toppling over.

(20) Storage of Cylindrical Material.

(a) Stack and block structural steel, poles, pipe, bar stock, and other cylindrical materials, unless racked, to prevent spreading or tilting.

(b) Do not stack pipe, unless racked, higher than 5 feet (1.5 m).

(c) Use either a pyramid or battened stack. Where a battened stack is used, securely chock the outside pile or pole. Taper back battened stacks at least one pile or pole in each tier.

(d) Unload round material using a method that does not require anyone to be on the unloading side of the carrier after the tie wires have been cut or during the unlocking of the stakes.

(21) Storage of Flammable Liquids.

(a) A QP must supervise all storage, handling, and use of flammable liquids to ensure conformance to 29 CFR 1910.106, 29 CFR 1926.152, NFPA 30, NFPA 30A.

(b) Fire Protection Requirements. See chapter 9 for additional fire protection requirements.

(b-1) Provide at least one portable fire extinguisher rated 20-B:C on all tank trucks or other vehicles used for transporting and/or dispensing flammable liquids.

(b-2) Provide each service or refueling area with at least one fire extinguisher rated not less than 40-B:C and located so that an extinguisher is within 100 feet (30.5 m) of each pump, dispenser, underground fill pipe opening, and lubrication or service area.

(c) When not in use, store Category 1 or 2 flammable liquids or Category 3 flammable liquids with a flashpoint below 100°F (37.8°C) in closed containers or tanks.

(d) Take protective measures to prevent any part of clothing from becoming contaminated with flammable fluids. Do not continue work if clothing becomes contaminated; remove or wet down the clothing as soon as possible.

(e) Do not use any flammable liquid with a flash point (closed cup test) below 100°F (37.8°C) for cleaning purposes or to start or rekindle fires.

(f) Provide ventilation adequate to prevent the accumulation of flammable vapors to hazardous levels according to this manual, applicable federal, state, and local requirements in all areas where flammable liquids are handled or used.

(g) Separate all sources of ignition, including smoking, at least 50 feet (15.2 m) from areas where flammable liquids are stored, handled, and processed. Conspicuously post with legible signs stating, "NO SMOKING, MATCHES, or OPEN FLAME."

(h) Use only approved and labeled or listed containers and portable tanks to store flammable liquids.

(h-1) Acceptable metal containers and portable tanks are those having less than 660 gal (2.5 m³) individual capacity and that meet the requirements of and contain products authorized according to 49 CFR Chapter I and United Nations Recommendations on the Transport of Dangerous Goods: Model Regulations - Twenty-Second Revised Edition, Chapter 9.

(h-2) Plastic containers used for the storage of petroleum products must meet the requirements of one or more of the following specifications: ASTM F852/F852M or ANSI/UL 1313.

(h-3) Acceptable plastic drums are those meeting the requirements of and containing products authorized according to United Nations Recommendations on the Transport of Dangerous Goods: Model Regulations - Twenty-Second Revised Edition, Chapter 9 .

(h-4) Acceptable fiber drums are those that meet the requirements according to paragraphs NMFTA/NMFC Item 296 or UFC 6000-M (see UFC Rule 51 for Types 2A, 3A, 3B-H, 3B-L, or 4A), and that meet the requirements of and contain liquid products authorized either according to paragraph 49 CFR Chapter I or by DOT exemption.

(i) Design, construct, use, and inspect of storage tanks containing flammable liquids according to NFPA 30.

(j) Tanks greater than 660-gal (2.5 m³) capacity must comply with NFPA 30 and NFPA 30A.

(k) The maximum allowable size for a container or portable metal tank less than 660 gal (2.5 m³) individual capacities must not exceed those shown in table 14-1.

(l) Design, construct, and use storage cabinets, indoor storage areas, outdoor storage areas, HAZMAT storage lockers, and other occupancies according to NFPA 30. For marine applications, 46 CFR 147 covers use of cabinets (that is, paint lockers) and 46 CFR 92.05-10 specifies design and construction.

(m) Do not store flammable liquids in quantities greater than that required for one day's use in buildings under construction. Do not store more than a two-day supply on paint barges.

(n) Do not store flammable liquids in areas used for exits, stairways, or passageways.

(o) Keep unopened containers of flammable liquids, such as paints, varnishes, lacquers, thinners, and solvents, in a well-ventilated location, free of excessive heat, smoke, sparks, flame, or direct rays of the sun.

(p) Provide and maintain a listed, self-closing, metal refuse can in good condition in areas where flammable liquids are handled or stored.

(q) Safety cans and other portable containers for flammable liquids having a flash point at or below 73°F (23°C) must be approved and labeled or listed, painted red, have a yellow band around the can, and include the name of the contents legibly indicated on the container.

(r) Surround storage areas and tanks with a curb, earthen dike, or other equivalent means of containment of at least 6 inches (15.2 cm) in height, and higher as needed, to contain the contents in the event of a leak.

(r-1) Other EPA or USCG approved secondary containment methods may be used in lieu of curbs or dikes (for example, double-walled tanks).

(r-2) When dikes or curbs are used, make provisions for draining accumulations of ground or rainwater or spills of flammable liquids.

(r-3) Terminate drains at a safe location. The drains must be accessible and operable in the event of a fire. Fuel and oil storage areas are subject to Oil Pollution Prevention requirements will use the provisions of 40 CFR 112 as well.

(s) Provide portable tanks less than 660-gal (2.5 m³) individual capacity with one or more devices, installed in the top, with sufficient emergency venting capacity to limit internal pressure under fire exposure conditions to 10 psi (68.9 kPa) gauge or 30% of the bursting pressure of the portable tank, whichever is greater.

(s-1) Use at least one pressure-actuated vent having a minimum capacity of 6,000 ft³ (170 m³) of free air per hour. It must be set to open at not more than 5 psi (34.5 kPa) gauge.

(s-2) If fusible vents are used, they must be actuated by elements that operate at a temperature not exceeding 300°F (148.9°C).

(s-3) Where plugging of a pressure-actuated vent can occur, fusible plugs or venting devices that soften to failure at a maximum of 300°F (148.9°C) under fire exposure may be used for the entire emergency venting requirement.

(t) Where liquids are used or handled, provisions must be made to dispose of leakage or spills quickly and safely.

(u) Flashlights and electric lanterns used while handling flammable liquids must be listed by a NRTL for the intended use.

(v) Dispensing Flammable Liquids.

(v-1) All pumping equipment used for the transfer of Category 1 or 2 flammable liquids or Category 3 flammable liquids with a flashpoint below 100°F (37.8°C) must either be listed by a NRTL or approved by and labeled or tagged according to the federal AHJ (for example, DOT).

(v-2) Dispensing systems for Category 1 or 2 flammable liquids or Category 3 flammable liquids with a flashpoint below 100°F (37.8°C) must be electrically bonded and grounded. All fuel tanks, hoses, and containers of 5 gal (18.9 L) or less must be kept in metallic contact while flammable liquids are being transferred; transfer of flammable liquids to containers in excess of 5 gal (18.9 L) will be done only when the containers are electrically bonded.

(v-3) Flammable liquids drawn from, or transferred into, vessels, containers, or tanks within a building or outside must be done only through a closed piping system, from safety cans, by means of a device drawing through the top, or from a container, or portable tanks, by gravity or pump, through an approved self-closing valve. Do not transfer by means of air pressure on the container or portable tank.

(v-4) Separate areas in which flammable liquids are transferred in quantities greater than 5 gal (18.9 L) from one tank or container to another from other operations by at least 25 feet (7.6 m) or a barrier having a fire resistance of at least one hour. Provide drainage or other means to control spills. Use natural or mechanical ventilation

to maintain the concentration of flammable vapor at or below 10% of the lower flammable limit.

(v-5) Protect dispensing units against collision damage by suitable means and securely bolt in place permanent dispensing units.

(v-6) Dispensing nozzles and devices for Category 1 or 2 flammable liquids or Category 3 flammable liquids with a flashpoint below 100°F (37.8°C) must be listed.

(v-7) Do not fill lamps, lanterns, heating devices, small engines, and similar equipment while hot. Fill these devices only in well-ventilated rooms free of open flames or in open air. Do not fill in storage buildings.

(v-8) Separate dispensing devices at least 20 feet (6.1 m) from any activity involving fixed sources of ignition.

(w) Service and Refueling Areas.

(w-1) Fuel dispensing hoses must be listed, designed, and used for their intended purpose. Dispensing nozzles must be an approved automatic-closing type without a latch-open device.

(w-2) Shut down equipment using flammable liquids as fuel during refueling, servicing, or maintenance, except for emergency generators. Waiver requests may be reviewed and granted by the local SOHO for operations in remote sites or regions where cold weather conditions pose a significant risk when equipment fails to restart. A copy must be provided to HQUSACE-SO.

(w-3) Use a listed pumping arrangement for dispensing of Category 1 or 2 flammable liquids or Category 3 flammable liquids with a flashpoint below 100°F (37.8°C) from tanks of 55-gal (0.21 m³) capacity or more. Do not transfer by air pressure on the container or portable tank.

(w-4) Provide clearly identified and easily accessible switch(es) at a location remote from dispensing devices to shut off the power to all dispensing devices in an emergency.

(w-5) Install a listed emergency breakaway device designed to retain liquid on both sides of the breakaway point on each hose dispensing Category 1 or 2 flammable liquids or Category 3 flammable liquids with a flashpoint below 100°F (37.8°C) liquids.

(x) Tank Cars/Trucks.

(x-1) Use a ground guide to spot tank cars/trucks during movement in congested and confined areas.

(x-2) Attend tank cars/trucks for the entire time they are being loaded or unloaded. Do not load or unload until brakes have been set and wheels chocked.

(x-3) Take precautions to prevent fire or other hazards. Properly bond and ground tank cars/trucks while being loaded or unloaded. Make bonding and grounding connections before dome covers are removed on tank cars/trucks and do not disconnect until such covers have been replaced. Relieve internal vapor pressure before dome covers are opened.

(22) LP-Gas.

(a) Store, handle, install, and use LP-Gas and systems according to 29 CFR 1926.153, 29 CFR 1910.110, NFPA 58, and USCG regulations, as applicable.

(b) LP-Gas containers, valves, connectors, manifold valve assemblies, regulators, and appliances must be of an approved type.

(c) Any appliance that was originally manufactured for operation with a gaseous fuel other than LP-Gas and is in good condition may be used with LP-Gas only after it is properly converted, adapted, and tested for performance with LP-Gas.

(d) Do not use polyvinyl chloride and aluminum tubing in LP-Gas systems.

(e) Where damage to LP-Gas systems from vehicular or equipment traffic could occur, protect against damage (for example, crash barriers, bollards).

(f) Safety Devices.

(f-1) Every container and vaporizer must be provided with one or more safety relief valves or devices. Arrange these valves and devices to afford free vent to the outside air and discharge at a point not less than 5 feet (1.5 m) horizontally from any building opening that is below the discharge point.

(f-2) Container safety relief devices and regulator relief vents must be located not less than 5 feet (1.5 m) in any direction from air openings into sealed combustion system appliances or mechanical ventilation air intakes.

(f-3) Do not install shut-off valves between the safety relief device and the container, or the equipment or piping to which the safety relief device is connected, except that a shut-off valve may be used where the arrangement of the valve is such that full required capacity-flow through the safety relief device is always afforded.

(g) Container Valves and Accessories.

(g-1) Valves, fittings, and accessories connected directly to the container, including primary shut off valves, must have a rated working pressure of at least 250 psi (1723.7 kPa) gauge and must be of material and design suitable for LP-Gas service.

(g-2) Connections to containers (except safety relief connections, liquid level gauging devices, and plugged openings) must have shutoff valves located as close to the container as practical.

(g-3) Regulators and low-pressure relief devices must be rigidly attached to the cylinder valves, cylinders, supporting standards, building walls, or otherwise rigidly secured and installed or protected from the elements.

(h) Arrange valves in the assembly of multiple container systems so that replacement of containers can be made without shutting off the flow of gas in the system (this is not to be construed as requiring an automatic changeover device).

(i) Do not use LP-Gas containers and equipment in unventilated spaces below grade in pits, below-decks, or other spaces where dangerous accumulations of heavier than-air gas may accumulate due to leaks or equipment failure.

(j) Do not perform welding on LP-Gas containers.

(k) Dispensing.

(k-1) Shut down equipment using LP-Gas during refueling operations.

(k-2) Perform filling of fuel containers for motor vehicles from bulk storage containers at least 10 feet (3 m) from the nearest masonry-walled building, at least 25 feet (7.6 m) from the nearest building of other construction, and, in any event, at least 25 feet (7.6 m) from any building opening.

(k-3) Perform filling from storage containers, of portable containers, or containers mounted on skids at least 50 feet (15.2 m) from the nearest building.

(l) Installation, Use, and Storage Outside of Buildings.

(l-1) Containers must be upright upon firm foundations or otherwise firmly positioned. Provide flexible connections (or other special fixtures) to protect against the possibility of the effect of settlement on the outlet piping.

(l-2) Store containers in a suitable ventilated enclosure or otherwise protect against tampering.

(l-3) When storing containers awaiting use outside of buildings, locate them away from the nearest building or group of buildings according to table 14-2.

(l-4) Provide storage areas with at least one approved portable fire extinguisher rated no less than 20-B:C. See chapter 9 for additional portable fire extinguisher requirements.

(m) Installation, Use, and Storage Inside of Buildings.

(m-1) In industrial buildings not normally frequented by the public, store only the number of containers that, in total, can hold no more than 300 lb. (2,623.8 ft³) of LP-Gas.

Note. When stored inside, empty containers which have been in LP-Gas service must be considered as full containers for the purpose of figuring out the maximum quantity of LP-Gas permitted.

(m-2) Do not place containers stored inside near exits, stairways, or in areas normally used for the safe exit of people.

(m-3) Protect container valves while in storage. Either set them into the recess of a container to prevent the possibility of it becoming struck if the container is dropped or fasten a ventilated cap or collar to the container. The cap or collar must be capable of withstanding a blow from any direction equivalent to that of a 30 lb. (13.6 kg) weight dropped 4 feet (1.2 m).

(m-4) Close all outlet valves on stored containers.

(m-5) Equip storage locations with at least one approved portable fire extinguisher having a minimum rating of 8-B:C. See chapter 9 for additional portable fire extinguisher requirements.

(m-6) Locate containers, regulating equipment, manifolds, pipe, tubing, and hose as to minimize exposure to high temperatures or physical damage.

(m-7) Do not exceed the maximum water capacity of individual containers of 245 lb. (111.1 kg) (that is, nominal 100 lb. (45.3 kg) LP-Gas capacity).

(m-8) Containers having a water capacity greater than 2.5 lb. (1.1 kg) (that is, nominal 1 lb. (0.5 kg) LP-Gas capacity) must stand on a firm and level surface and, when necessary, secured in an upright position. Equip systems using containers having a water capacity greater than 2.5 lb. (1.1 kg) with excess flow valves, either within the container valves or in the connections to the container valve outlets.

(m-9) Connect regulators directly to the container valves or to manifolds that are connected to the container valves. The regulator must be suitable for use with LP-Gas.

Design manifolds and fittings connecting containers to pressure regulator inlets for at least 250 psi (1723.7 kPa) gauge service pressure.

(m-10) Protect valves on containers having water capacity greater than 50 lb. (22.7 kg) (nominal 20 lb. (9 kg) LP-Gas capacity) from damage while in use or storage.

(m-11) Design hoses for working pressure of at least 250 psi (1723.7 kPa) gauge. All hoses and connections must be listed for the intended application in relation to design, construction, and performance. Hoses must be as short as possible, but long enough to permit compliance with spacing requirements without kinking, straining, or damaging them by heat.

c. Material Disposal. (14-8.c)

(1) Place waste material and rubbish in containers or, if appropriate, in piles.

(a) Label as waste all containers holding waste material and piles or stacks of waste.

(b) Place waste material away from any traffic areas or walkways and pile or stack it in such a manner as to prevent engulfment or material avalanche.

(2) Do not drop waste materials or rubbish down from a height of more than 6 feet (1.8 m) unless the following are complied with:

(a) The materials or rubbish are dropped through an enclosed chute constructed of wood or equivalent material. Enclose debris chutes, except for openings equipped with closures at or about floor level for the insertion of materials. The openings must not exceed 4 feet (1.2 m) in height measured along the wall of the chute. Keep openings closed when not in use.

(b) When debris cannot be handled by chutes, enclose the area into which the material is dropped with barricades not less than 42 inches (106.7 cm) in height. Position barricades to keep personnel from all debris landing areas. Post signs warning of the hazard of falling material at all debris landing areas and at each level exposed to falling debris.

(3) Perform burning operations according to chapter 9.

(4) Provide covered, self-closing, nonflammable, and non-reactive containers for the collection of garbage and oily, flammable, and dangerous wastes.

(a) Label each container with a description of the contents.

(b) Properly dispose the contents daily.

(5) Collect, store, and dispose of hazardous material waste (for example, vehicle and equipment oils and lubricants, containers and drums for solvents, adhesives) according to chapter 6, applicable federal, state, and local requirements.

(6) Dispose of combustible waste materials according to all applicable fire and environmental laws and regulations.

(7) Housekeeping.

(a) Maintain work areas and means of access as safe and orderly.

(b) Provide sufficient personnel and equipment to ensure compliance with all housekeeping requirements.

(c) Do not perform work in those areas that do not comply with the requirements of this chapter.

(d) Do not store or leave on roofs any loose or light material that is not enclosed or secured.

(e) Tools, materials, extension cords, hoses, or debris must not cause tripping or other hazards.

(f) Secure tools, materials, and equipment that are subject to displacement or falling.

(g) Periodically remove empty bags having contained lime, cement, and other dust-producing material.

(h) Clear formwork and scrap lumber and debris from work areas and accessways in and around building storage yards and other structures.

(i) During disassembly, render protruding nails in scrap boards, planks, and timbers safe by removing them, hammering them in, or bending them flush with the wood.

(j) Keep storage and construction sites free from the accumulation of combustible materials.

(j-1) Keep down weeds and grass.

(j-2) Establish a regular cleanup procedure.

(j-3) Keep rubbish, brush, long grass, or other combustible material away from areas where flammable and combustible liquids are stored, handled, or processed.

(k) Do not allow liquids, particularly flammable and combustible liquids, to accumulate on work area surfaces (for example, floors, walls). Immediately clean up all spills of flammable and combustible liquids.

14-9. Figures and Tables.

Table 14-1
Maximum Allowable Size of Portable Container and Tanks for Flammable Liquids

Container Type	Flammable Liquids Categories 1	Flammable Liquids Categories 2	Flammable Liquids Categories 3	Flammable Liquids Categories 4
Glass	16 oz (473 ml)	32 oz (946 ml)	1 gal (3.8 L)	1 gal (3.8 L)
Metal (other than DOT drums or approved plastic)	1 gal (3.8 L)	5 gal (19 L)	5 gal (19 L)	5 gal (19 L)
Safety cans	2 gal (7.6 L)	5 gal (19 L)	5 gal (19 L)	5 gal (19 L)
Metal drum (DOT) specifications	60 gal (8ft ³) (0.23 m ³)	60 gal (8ft ³) (0.23 m ³)	60 gal (8ft ³) (0.23 m ³)	60 gal (8ft ³) (0.23 m ³)
Approved portable tanks	660 gal (88.3 ft ³) (2.5 m ³)	660 gal (88.3 ft ³) (2.5 m ³)	660 gal (88.3 ft ³) (2.5 m ³)	660 gal (88.3 ft ³) (2.5 m ³)

Note:

- ¹ Flammable liquid means any liquid having a flashpoint at or below 199.4°F (93°C). Flammable liquids are divided into four categories as follows:
- ² Category 1 includes liquids having flashpoints below 73.4°F (23°C) and having a boiling point at or below 95°F (35°C).
- ³ Category 2 includes liquids having flashpoints below 73.4°F (23°C) and having a boiling point above 95°F (35°C).
- ⁴ Category 3 includes liquids having flashpoints at or above 73.4°F (23°C) and at or below 140°F (60°C). When a Category 3 liquid with a flashpoint at or above 100°F (37.8°C) is heated for use to within 30°F (-1.1°C) of its flashpoint, it must be handled according to the requirements for a Category 3 liquid with a flashpoint below 100°F (37.8°C).
- ⁵ Category 4 includes liquids having flashpoints above 140°F (60°C) and at or below 199.4°F (93°C). When a Category 4 flammable liquid is heated for use to within 30°F (-1.1°C) of its flashpoint, it must be handled according to the requirements for a Category 3 liquid with a flashpoint at or above 100°F (37.8°C).

Table 14-2
Outside Storage of LP-Gas Containers and Cylinders – Minimum Distances

Quantity of LP-Gas Stored	Distance
Less than 500 lb. (227 kg)	0 feet
500 lb. (227 kg)	10 feet (3 m)
6,000 lb. (2,722 kg)	10 feet (3 m)
6,000 lb. (2,722 kg)	20 feet (6.1 m)
10,000 lb. (4536 kg)	20 feet (6.1 m)
More than 10,000 lb. (4536 kg)	25 feet (7.6 m)

14-10. Checklists and Forms.

Not Applicable.

Chapter 15
Rigging

15-1. References.

a. ASME B30, Cranes and Related Equipment - Cableways, Derricks, Hoists, Hooks, Jacks, and Slings (<https://www.asme.org>) (15-1.a)

b. 29 CFR 1910.184, Slings (<https://www.govinfo.gov/content/pkg/CFR-2020-title29-vol5/pdf/CFR-2020-title29-vol5-sec1910-184.pdf>) (15-1.b)

c. 29 CFR 1926.251, Rigging Equipment for Material Handling (<https://www.govinfo.gov/content/pkg/CFR-2020-title29-vol8/pdf/CFR-2020-title29-vol8-sec1926-251.pdf>) (15-1.c)

d. 29 CFR 1926, Subpart CC Cranes and Derricks in Construction (<https://www.govinfo.gov/content/pkg/CFR-2020-title29-vol8/pdf/CFR-2020-title29-vol8-part1926-subpartCC.pdf>) (15-1.d)

15-2. Definitions.

a. Qualified Rigger (QR). A qualified rigger is a rigger who meets the criteria for a QP as defined in this manual (see paras 1-2 or 2-2, as applicable) and 29 CFR 1926, Subpart CC that is designated by the employer in writing to rig loads and/or oversee the rigging of loads for hoisting. (15-2.a)

b. Rated Load. The maximum allowable working load established by the rigging equipment manufacturer. The terms “rated capacity” and “working load limit” (WLL) are commonly used to describe rated load. (15-2.b)

c. Registered Professional Engineer (RPE). See paragraphs 1-2 or 2-2, as applicable. (15-2.c)

d. Rigging. Components used to secure, lift, and suspend loads (for example, chains, ropes, slings, cables). (15-2.d)

e. Rigging Hardware. Hardware components used in tandem with rigging to secure, lift, and suspend loads (for example, shackles, hooks, links, rings, swivels, turnbuckles, eyebolts, hoist rings, wire rope clips, wedge sockets). (15-2.e)

15-3. Personnel Required Qualification/Training.

Qualified Rigger (QR) will possess a recognized degree, certificate, or professional standing, or have extensive knowledge, training, and experience, and can successfully demonstrate the ability to solve problems related to rigging loads.

Note. The level of training, experience, and knowledge needed may vary depending on the rigging tasks. The employer must determine whether a person is qualified to perform specific rigging tasks.

a. Qualifications. QRs must meet at least the following minimum qualifications: (15-3.a)

(1) Have extensive knowledge, training, and experience and demonstrates such ability in safe rigging principles and procedures related to the work activities performed, to include calculating loads, load weights, and safe capacities.

(2) Be at least 18 years of age.

b. Training. QRs must be trained and demonstrate proficiency on the following related to the specific rigging operations they perform: (15-3.b)

(1) Load calculations and safe capacities.

(2) Rigging principles and procedures.

(3) Rigging and hoisting equipment operating characteristics, capabilities, and limitations.

(4) Personnel roles and responsibilities.

(5) Site preparation.

(6) Rigging and hoisting related hazards.

(7) Inspection procedures for rigging equipment.

Note. The term “rigger” or “Qualified Rigger (QR)” in this manual refers to the function performed, and in no way relates to the worker’s job classification or position.

15-4. Roles and Responsibilities.

QRs are responsible for rigging loads and overseeing rigging and hoisting operations to include the following:

- a. Verify site preparation is suitable for operations. (15-4.a)
- b. Identify rigging equipment and materials to be used. (15-4.b)
- c. Inspect rigging according to paragraph 15-5. (15-4.c)
- d. Establish and ensure adherence to safe operating and rigging procedures. (15-4.d)
- e. Identify hazards, including environmental hazards and overhead interferences, and implement controls. (15-4.e)
- f. Communicate with the crane operator, lift director, signal person, and other affected personnel. (15-4.f)

15-5. Inspection Requirements.

A QR must inspect all rigging and rigging hardware according to the manufacturer’s instructions and applicable OSHA and ASME B30 standards, and the following:

a. Shift Inspections. All rigging and rigging hardware must be inspected by a QR according to the manufacturer’s instructions and applicable OSHA and ASME B30 standards before use on each shift and as necessary during its use to ensure that it is free from damage or defects. (15-5.a)

b. Periodic Inspections. All rigging and rigging hardware must be inspected by a QR according to the manufacturer’s instructions and applicable OSHA and ASME B30 standards at least annually. All periodic inspections must be documented. A written record of the most recent periodic inspection of rigging and rigging hardware must be maintained and must include the condition of the rigging equipment. This documentation must be available onsite and available to the local SOHO/USACE supervisor/KO or COR upon request. The QR may adjust the frequency to require more frequent inspections based on any of the following: (15-5.b)

- (1) Frequency of use.
- (2) Severity of service conditions.
- (3) Nature of load-handling activities.

(4) Experience gained on the service life of rigging equipment used in similar circumstances.

Note. Unlike general rigging, rigging hardware components do not need to be listed individually on inspection forms.

c. Markings. Required markings must remain legible on all rigging equipment and hardware. If markings become illegible, remove from service. (15-5.c)

d. Damaged or defective rigging must be immediately removed from service. (15-5.d)

15-6. Activity Hazard Analysis (AHA) Requirements.

Develop AHAs according to paragraphs 1-6 or 2-6, as applicable. Plan and address all rigging activities, identify use of any specialty-type hooks (for example, open hooks, grab hooks, foundry hooks, sorting hooks, chocker hooks) in the AHA and submit for approval by the USACE supervisor or acceptance by the KO or COR.

15-7. Minimum Plan Requirements.

If multiple lift rigging (MLR) assembly is used, a Critical Lift Plan is required (see para 16-7).

15-8. General Requirements.

a. General Rigging Equipment and Hardware Requirements. (15-8.a)

(1) Use, inspect, maintain, and store all rigging equipment and hardware according to the manufacturer's instructions and applicable OSHA and ASME B30 standards. Do not load in excess of the WLL.

(2) When not in use, remove rigging equipment and hardware from the immediate work area and properly store and maintain in a safe condition.

b. Hoist Rope. Do not wrap hoist rope around the load. Attach the load to the hook by means of slings or other devices of sufficient capacity. (15-5.b)

c. Slings. (15-5.c)

(1) Use slings according to 29 CFR 1910.184 and 29 CFR 1926.251, as applicable.

(2) When slings may contact edges, corners, protrusions, abrasive surfaces, or connecting hardware, provide protection with a material of sufficient strength, thickness, and construction to prevent damage, unless the edges are adequately rounded to a radius as recommended by the sling manufacturer or a QP.

(3) All slings must be manufactured under applicable ASME B30 guidelines and must have an affixed durable permanent identification tag that includes at least the following:

(a) Name or trademark of the manufacturer (country identification only is not acceptable).

(b) Type of material used (synthetic web slings, synthetic round slings or synthetic rope slings only).

(c) WLL for a given type of hitch and configuration.

(d) Number of legs if more than one.

(4) All eye splices must be made according to applicable ASME B30 standards.

(5) Do not use alloy steel wire rope clips or clamps with eye slings or endless loop slings to hoist or lift material, except where the application precludes the use of prefabricated slings. An RPE must design all slings fabricated using alloy steel wire rope clips or clamps for the specific application. (See figures 15-1 and 15-2)

(6) Do not use natural fiber rope to fabricate slings.

d. Alloy Steel Chain Slings. (15-5.d)

(1) Use only alloy chain Grade 80 or higher for rigging.

(2) When used with multiple leg slings, use only attachments (for example, alloy steel chains, hooks, rings, oblong links, pear-shaped links, welded or mechanical coupling links) with a WLL at least equal to that of the assembly chain.

(3) Multiple leg slings must have the number of legs and lengths identified on the tag.

e. Rigging Hardware. (15-5.e)

(1) Do not paint rigging hardware unless approved by the manufacturer and according to the manufacturer's requirements. While the painting of rigging gear for identification is common, USACE considers this an unacceptable practice that constitutes a dangerous condition. Painting of hardware can potentially cover/hide defects creating an unsafe condition.

(2) Drums, sheaves, and pulleys must be smooth and free of surface defects that may damage rigging. Drums, sheaves, or pulleys having eccentric bores, cracked hubs, spokes, or flanges must be removed from service.

(3) Connections, fittings, fastenings, and attachments used with rigging must be of good quality, of proper size and strength, and must be installed according to the manufacturer's instructions.

(4) Do not use job hooks, shop hooks and links, makeshift fasteners formed from bolts and rods, or other similar attachments, unless they are according to paragraph 15-8.j.

f. Shackles. (15-5.f)

(1) All shackles must be manufactured according to ASME B30.26.

(2) Only shackles marked by manufacturer with name or trademark of manufacturer (country only is not acceptable), WLL, and size will be used. Shackles must be maintained by the user to be legible throughout the service life of the shackle.

(3) Each shackle pin must be marked by manufacturer to show name or trademark of manufacturer and grade material type or load rating.

(4) Shackle repairs and/or modifications may only be as specified by the manufacturer. Replacement parts and like pins must meet or exceed the original manufacturer's specifications.

(5) Use and load shackles according to the manufacturer's instructions. Do not apply multiple sling legs to the shackle pin.

(6) If a shackle is to be side loaded, the rated load must be reduced according to the recommendations of the manufacturer, ASME B30.26, or a QP.

g. Hooks. (15-5.g)

(1) All hooks used for lifting or load handling purposes must be manufactured and used according to ASME B30.10.

(2) Do not use hooks in any such manner other than that stated by the manufacturer's instructions.

(3) Remove from service any hooks that show wear exceeding 10% or an increase in the throat opening of 5%, maximum of one-quarter ($\frac{1}{4}$) inch (0.6 cm), or as recommended by the manufacturer, or hooks that exhibit any visibly apparent bend or twist from the plane of the hook.

(4) Follow manufacturer's instructions when determining a hooks WLL as there are various sizes and types of specific and identifiable hooks. Any hook for which the manufacturer's instructions are not available must be tested to twice the intended safe

working load before it is put into use. The employer must maintain a record of the dates and results of such tests.

(5) Manufacturer's identification (country only is not acceptable) and WLL must be forged, cast, or die stamped on a low stress and non-wearing area of the hook. Hooks must be maintained by the user to be legible throughout the service life of the hook.

(6) Load equally duplex (sister) hooks on both sides unless the hook is specifically designed for single-point loading.

(7) If the duplex (sister) hook is loaded at the pinhole instead of at the two saddles, the load applied must not exceed the WLL that would normally be shared by the two saddles or the WLL of the supporting equipment.

(8) Use safety latch-type hooks (for example, self-closing, self-locking, screw-pin shackle, alloy anchor type shackle with a bolt, nut, and retaining pin) whenever possible. Open hooks (for example, grab hooks, foundry hooks, sorting hooks, choker hooks) may be used to hoist loads if they are inspected and maintained according to the manufacturer's instructions.

h. Eyebolts, Eye Nuts, Swivel Hoist Rings, and Turnbuckles. (15-5.h)

(1) All eyebolts, eye nuts, swivel hoist rings, and turnbuckles must be manufactured according to ASME B30.26.

(2) Do not exceed the manufacturer's WLLs.

(3) Each turnbuckle, eye nut, swivel hoist ring, and eyebolt must be marked with name or trademark of the manufacturer (country is not acceptable), size or WLL and grade (for alloy eyebolts). In addition, each swivel hoist ring must also be marked to show torque value (excluding trench cover hoist rings). Components must be maintained by the user to be legible throughout the service life.

(4) Do not side load turnbuckles. Rig and secure to prevent unscrewing during the lift. In addition, end-fittings threads must be fully engaged in the body threads.

i. Non-Shoulder Eyebolts. Only use eyebolts not shouldered to the load for in-line loads. (15-5.i)

j. Custom Below-the-Hook Lifting devices. Custom below-the-hook lifting devices, (for example, structural and mechanical lifting devices, custom fabricated grabs, hooks, clamps, or other lifting accessories (for example, equalizing beams, lifting or spreader beams) for such units as modular panels, prefabricated structures and similar materials must be designed, tested, and used according to ASME B30.20. (15-5.j)

k. Multiple Lift Rigging (MLR). MLR assembly requirements are addressed in chapter 16. (15-5.k)

15-9. Figures and Tables.

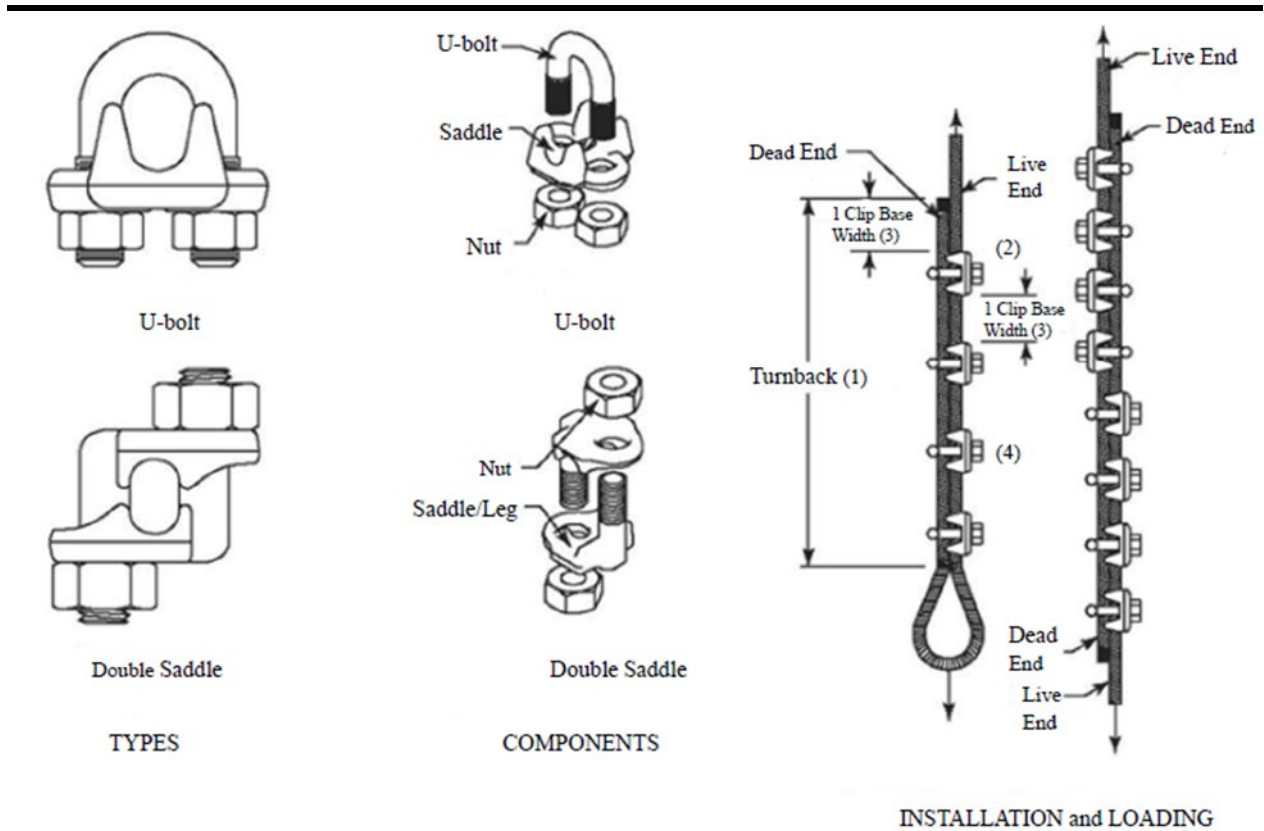

GENERAL NOTE: Correct number of clips for wire rope size must be used.

NOTES:

- (1) Correct turnback length should be used.
- (2) Correct orientation of saddle on live end must be observed.
- (3) Correct spacing of clips should be used.

Figure 15-1. Wire Rope Clip Spacing (see para 15-5.c)

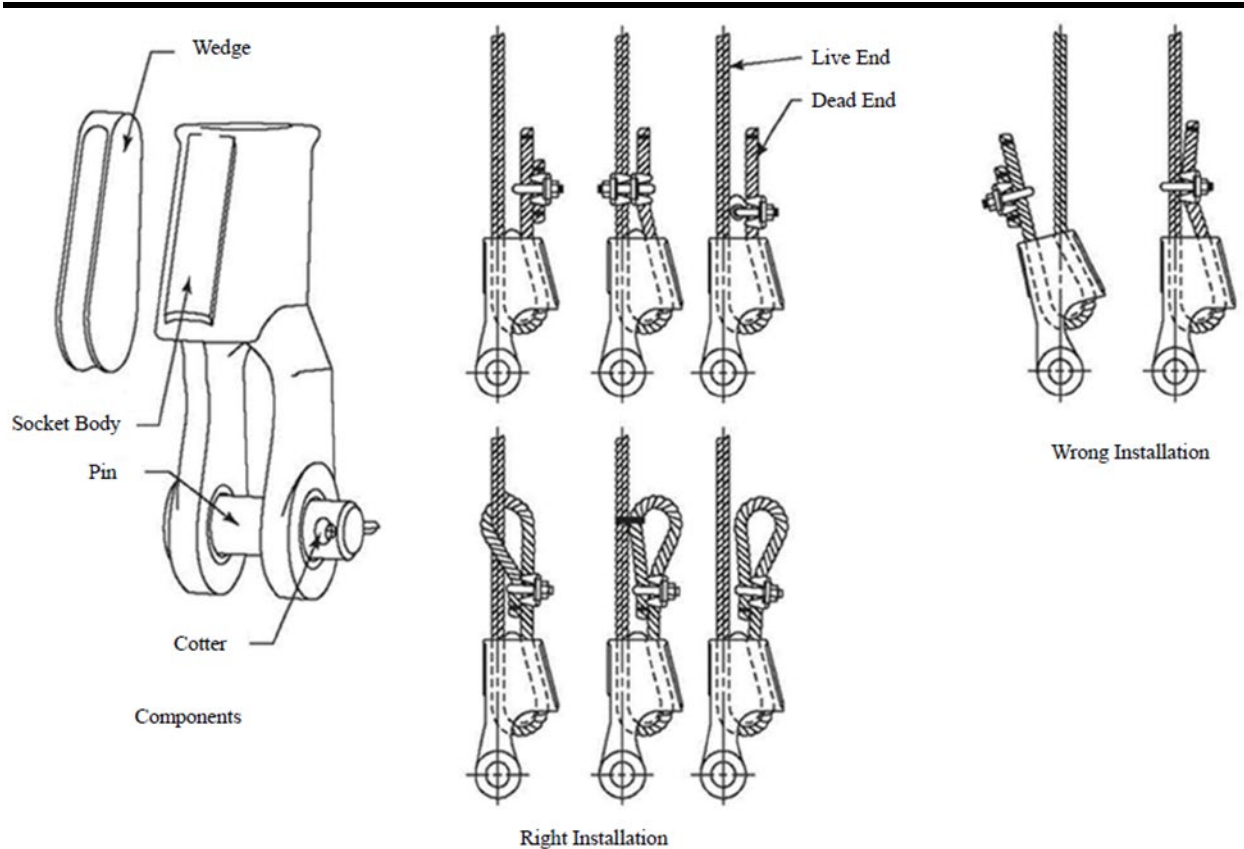

Figure 15-2. Wire Rope Clip Orientation

15-10. Checklists and Forms.

Not Applicable.

Chapter 16

Load Handling Equipment

The requirements of this chapter apply to all LHE with a hoisting or lifting capacity over 2,000 lbs. (907.2 kg). LHE includes cranes, derricks, hoists, and power-operated equipment (excavators, forklifts, rough terrain equipment) when used with rigging that can raise, lower, and horizontally move a suspended load.

a. Helicopter Operations. Refer to 29 CFR 1910.183 and 29 CFR 1926.551 for helicopter operations that are configured to hoist loads.

b. Hoisting/Lifting Capacity. Refer to 29 CFR 1926.1441 (29 CFR 1926 Subpart CC) for LHE with a rated hoisting/lifting capacity of 2,000 lbs. (907.2 kg) or less.

c. Exemptions. All requirements of this chapter apply except as noted below:

(1) Affixed A-frames or dredge-related operations, while performing anchor handling, are exempt from LHE operator training, physical requirements, and Naval Architectural Analysis (NAA).

(2) Digger derricks used for utility pole installation.

(3) Vehicle-mounted aerial devices (bucket trucks), vehicle-mounted elevating and rotating work platforms (aerial devices, lifts), and elevating aerial work platforms (AWPs).

(4) Hydraulic excavators, wheeled, trackhoe or backhoe loaders used to hoist loads with rigging are exempt only from LHE operator training requirements (for example, crane operator certifications). Rigger qualifications still apply.

(5) Powered industrial trucks (PIT's) (forklifts, telehandlers) are exempt from crane operator certifications when configured to hoist and lower by a winch or hook and horizontally move a suspended (rigged) load. Rigger qualifications still apply.

(6) Machinery that hoists by using a come-along or chainfall, whether human, air, or electric powered, chain or wire rope type.

(7) Operators of equipment with a maximum manufacturer-rated hoisting/lifting capacity of 2,000 lbs. (907.2 kg) or less are exempt from the operator qualification or certification requirements. Do not use this equipment to hoist personnel.

(8) Operators of Class II hoisting equipment are exempt from medical requirements unless this equipment is used to hoist/lift personnel.

(9) Dedicated drilling rigs.

(10) Tree trimming and removal work.

(11) Gin poles, when used for the erection of communication towers.

(12) Helicopter cranes are exempt from paragraph 16-3.

(13) Stacker cranes.

(14) Mechanic's trucks with a hoisting device, when used in activities related to maintenance and repair.

(15) Material Delivery.

(a) Articulating/knuckle-boom truck cranes that deliver material to a construction site, when used to transfer materials from the truck crane to the ground without arranging the materials in a particular sequence for hoisting.

(b) Articulating /knuckle-boom truck cranes that deliver material to a construction site when used to transfer building supply sheet goods or building supply packaged materials from the truck crane onto a structure, using a fork/cradle at the end of the boom, but only when the truck crane is equipped with a properly functioning automatic overload prevention device. Such sheet goods or packaged materials include but are not limited to sheets of sheet rock, sheets of plywood, bags of cement, sheets or packages of roofing shingles, and rolls of roofing felt.

(c) This exclusion does not apply when:

(c-1) The articulating crane is used to hold, support, or stabilize the material to facilitate a construction activity, such as holding material in place while it is attached to the structure.

(c-2) The material being handled by the articulating crane is a prefabricated component. Prefabricated components include precast concrete members or panels, roof trusses (wooden, cold-formed metal, steel), prefabricated building sections floor panels, wall panels, roof panels, roof structures), and similar items.

(c-3) The material being handled by the crane is a structural steel member (steel joists, beams, columns, steel decking (bundled or unbundled) or a component of a systems-engineered metal building).

(16) Rescue boat and lifeboat launch systems that are designated for launching rescue lifeboats and regulated by the USCG and the International Convention for the Safety of Life at Sea.

16-1. References.

a. American Petroleum Institute (API) Specification 2C
(<https://www.api.org/products-and-services/standards/important-standards-announcements/spec2c>) (16-1.a)

b. ANSI/ASSE A10.22, Construction and Demolition Operations - Safety Requirements for Rope-Guided and Non-Guided Worker's Hoists
(<https://webstore.ansi.org/>) (16-1.b)

c. AR 600-85, The Army Substance Abuse Program
(<https://armypubs.army.mil/ProductMaps/PubForm/AR.aspx>) (16-1.c)

- d. ASME B30, Safety Standard for Cableways, Cranes, Derricks, Hoists, Hooks, Jacks, and Slings (<https://www.ansi.org>) (16-1.d)
- e. Federal Motor Carrier Safety Administration (FMCSA) National Registry of Certified Medical Examiners (<https://www.fmcsa.dot.gov/national-registry-certified-medical-examiners-search>) (16-1.e)
- f. NFPA 70, National Electric Code (<https://www.nfpa.org/Codes-and-Standards>) (16-1.f)
- g. 29 CFR 1910.178, Powered Industrial Trucks (<https://www.govinfo.gov/content/pkg/CFR-2020-title29-vol5/pdf/CFR-2020-title29-vol5-sec1910-178.pdf>) (16-1.g)
- h. 29 CFR 1910.179, Overhead and Gantry Cranes (<https://www.govinfo.gov/content/pkg/CFR-2020-title29-vol5/pdf/CFR-2020-title29-vol5-sec1910-179.pdf>) (16-1.h)
- i. 29 CFR 1910.180, Crawler Locomotive and Truck Cranes (<https://www.govinfo.gov/content/pkg/CFR-2020-title29-vol5/pdf/CFR-2020-title29-vol5-sec1910-180.pdf>) (16-1.i)
- j. 29 CFR 1910.181, Derricks (<https://www.govinfo.gov/content/pkg/CFR-2020-title29-vol5/pdf/CFR-2020-title29-vol5-sec1910-181.pdf>) (16-1.j)
- k. 29 CFR 1910.183, Helicopters (<https://www.govinfo.gov/content/pkg/CFR-2020-title29-vol5/pdf/CFR-2020-title29-vol5-sec1910-183.pdf>) (16-1.k)
- l. 29 CFR 1926.551, Helicopters (<https://www.govinfo.gov/content/pkg/CFR-2020-title29-vol8/pdf/CFR-2020-title29-vol8-sec1926-551.pdf>) (16-1.l)
- m. 29 CFR 1926.603, Pile Driving Equipment (<https://www.govinfo.gov/content/pkg/CFR-2020-title29-vol8/pdf/CFR-2020-title29-vol8-sec1926-603.pdf>) (16-1.m)
- n. 29 CFR 1926, Subpart CC Cranes and Derricks in Construction (<https://www.govinfo.gov/content/pkg/CFR-2020-title29-vol8/pdf/CFR-2020-title29-vol8-part1926-subpartCC.pdf>) (16-1.n)
- o. 46 CFR 173, Special Rules Pertaining to Vessel Use (<https://www.govinfo.gov/content/pkg/CFR-2020-title46-vol7/pdf/CFR-2020-title46-vol7-part173.pdf>) (16-1.o)

16-2. Definitions.

a. Articulating Boom Crane (also known as, knuckle boom crane). A crane with two or more boom sections that pivot (articulate) by hydraulic cylinders. The boom may have a telescoping section. The crane can be stationary or mounted on a vehicle, track, locomotive) and is used to lift, swing, and lower loads. (16-2.a)

b. Boom. A member hinged to the superstructure of cranes and derricks and used for supporting hoisting tackle. (16-2.b)

c. Boom Angle. The angle of the boom relative to horizontal. (16-2.c)

d. Boom Angle Indicator. A device that measures the angle of the boom relative to the horizontal. (16-2.d)

e. Boom Stop. A device used to limit the angle of the boom from moving above a certain maximum angle and toppling over backward. (16-2.e)

f. Bridge. The part of a gantry or overhead crane that carries the trolley(s). (16-2.f)

g. Class I Crane/Hoist Types. (16-2.g)

(1) Fixed cab telescopic hydraulic mobile cranes.

(2) Swing cab telescopic hydraulic mobile cranes.

(3) Lattice boom, truck, or crawler cranes.

(4) Cab-operated overhead, bridge, gantry, under hung and monorail cranes.

(5) Pedestal cranes.

(6) Remote-operated (wireless) overhead, bridge, gantry, under hung and monorail cranes over 30 ton (T) (27.2 metric ton (MT)) capacity.

(7) Hammerhead cranes.

(8) Portal cranes.

(9) Tower cranes.

(10) Post or stiff leg type derricks.

(11) Spider cranes.

(12) Floating or barge mounted LHE, temporarily or permanently mounted, that requires a NAA floating load chart according to this chapter.

h. Class II Crane/Hoist Types. (16-2.h)

(1) All hard-wired, pendant-mounted operated overhead, bridge, and gantry cranes.

(2) Under hung.

(3) Monorail.

(4) Wall-mounted jib cranes.

(5) Any remote-operated (wireless) overhead, bridge, gantry, under hung and monorail cranes 30T (27.2 MT) capacity or less.

i. Competent Person (CP), Cranes and Rigging. A person designated in writing by the employer to be responsible for the immediate supervision, implementation, and monitoring of the Crane and Rigging Program. Must have sufficient training, knowledge, and experience in crane(s) and rigging and be capable of identifying, evaluating, and addressing existing and potential hazards and must have the authority to take prompt corrective measures with regard to such hazards. The term "Competent Person" (CP), as used in this chapter, refers to "Competent Person, Cranes and Rigging". (16-2.i)

j. Critical Lift. A non-routine crane lift requiring detailed planning and additional or unusual safety precautions. The following lifts are defined as critical lifts and require detailed planning and added safety precautions. (16-2.j)

(1) Lifts involving HAZMAT (for example, explosives, highly volatile substances).

(2) Hoisting personnel with LHE.

(3) Lifts made with more than one LHE.

(4) Lifts where the center of gravity (CG) could change.

(5) Lifts that exceed 75% of the load chart of the LHE during construction work.

(6) Lifts without the use of outriggers using rubber tire load charts.

(7) Lifts using more than one hoist on the same LHE.

(8) Lifts involving MLR assemblies or other non-routine or technically difficult rigging arrangements.

(9) Lifts involving submerged loads.

Note. Exception. Lifts that are engineered to travel in guided slots throughout the lift and have fixed rigging and/or lifting beams (for example, intake gates, tailgates/logs) are not considered critical lifts.

Note. Exception. Affixed A-frames or dredge-related operations, while performing tasks that the equipment was specifically designed to do, are exempt from critical lift requirements.

(10) Lifts out of the operator's view.

Note. Exception. If hand signals are used by a signal person in view of the operator or radio communications are available and in use, the load does not exceed 2T (1.8MT), and it is determined a routine lift by the lift director, then it is not considered a critical lift.

(11) Load tests.

(12) When land based LHE mounted on barges, pontoons, or other means of flotation are required to travel while lifting the load.

(13) When two or more tower cranes are set up in the same operating envelope.

(14) Any lift the operator, lift director, supervisor, or employer believes should be considered critical.

k. Derrick. An apparatus consisting of a mast or equivalent member held at the end by guys or braces, with or without a boom, for use with a hoisting mechanism and operating ropes. (16-2.k)

l. Design Load. The maximum intended load, that is, the total of all loads including the worker(s), material, and the equipment placed on the unit. (16-2.l)

m. Jib. On hammerhead cranes, the horizontal structural member attached to the rotating superstructure of a crane and upon which the load trolley travels. On mobile cranes, an extension attached to the boom to provide added boom length for lifting specified loads. (16-2.m)

n. Lift Director. The person designated to direct the load handling activity. They must have a thorough knowledge of safety procedures for the crane, rigging, employee conduct, and be both a CP and a QP working with the specific LHE being used. The person may be the crane operator or another individual. (16-2.n)

o. Load Handling Equipment (LHE). A term used to describe cranes, hoists, and all other hoisting equipment (hoisting equipment means equipment, including excavators or forklifts, used with rigging to hoist and move a load). (16-2.o)

- p. Load Indicator. A device that measures the weight of the load. (16-2.p)
- q. Load Moment Indicator (LMI) (rated capacity indicator). A device that indicates the bending moment on a crane by measuring both the load on a boom and the horizontal distance from the load (boom point) to the crane's axis of rotation. LMI are often equipped with warning devices or disengaging devices that are actuated before a crane is overloaded. (16-2.q)
- r. Operating Envelope. The area surrounding any crane. Inside this "envelope" is the crane, the 360-degree area up to the crane's maximum working radius, the operator, riggers, and crane walkers, rigging gear between the hook and the load, the load and the crane's supporting structure (for example, ground, rail). (16-2.r)
- s. Operational Test. A test to evaluate if the crane is operating properly and its ability to safely lift loads within its performance rating. The test includes operational performance tests and load performance tests. (16-2.s)
- t. Qualified Person (QP). See paragraphs 1-2 or 2-2, as applicable. (16-2.t)
- u. Rated Load. The maximum allowable working load established by the rigging equipment manufacturer. The terms "rated capacity" and "working load limit (WLL)" are commonly used to describe rated load. (16-2.u)
- v. Registered Professional Engineer (RPE). See paragraphs 1-2 or 2-2, as applicable. (16-2.v)
- w. Two-Block Damage Prevention Device (also known as anti-two blocking (A2B)). A system that stops the current function so that a hoist rope or crane machinery components are not damaged. (16-2.w)
- x. Two-Block/A2B Warning Device. A warning device to alert the operator of an impending two blocking condition. (16-2.x)
- y. Working Load. The external load applied to the crane or derrick, including the weight of load-attaching equipment such as load blocks, shackles, and slings. (16-2.y)

16-3. Personnel Required Qualification/Training.

- a. Only properly trained, certified, and qualified personnel that are designated in writing by the employer may operate LHE. Prior to designating any LHE operator, the employer must obtain the intended operational functions and proof of qualifications for the operator. The employer may designate the following personnel to operate LHE under limited conditions: (16-3.a)
- (1) Trainees under the direct supervision of the designated operator of the LHE.

(2) LHE maintenance, inspection, and repair personnel are permitted to operate the equipment only where all of the following requirements are met:

(a) The operation is limited to those functions necessary for maintenance, equipment inspection or performance verification.

(b) No lifting of loads. They may only operate the equipment under the direct supervision of a qualified operator or they must read and review the specific LHE operations manual so that they are familiar with the operations, limitations, characteristics, and associated hazards.

b. Lift Director Requirements. Must be competent and qualified on lift operations and have the ability to develop, review and approve lift plans. (16-3.b)

c. Crane Operator Requirements. (16-3.c)

(1) Crane operators must successfully complete written and operational testing to become certified.

(2) Qualification of all crane/hoist operators must be made by the employer after a review of the certification documents. Qualification includes completed certification documents. Qualifications also include employer verification that the operator is familiar with the equipment and has adequate knowledge of USACE and OSHA crane safety requirements and the procedures and recommendations in the specific crane's operation manual.

(3) Crane operators must demonstrate their ability to read, write, and comprehend the language of the crane manufacturer's operation and maintenance instruction materials. They must exhibit acceptable arithmetic skills, be able to use load charts, and follow written manufacturer's procedures applicable to the type and configuration of the equipment.

(4) Operators of A-frame non-slewing anchor handling barges or vessels must be trained in the anchor handling barge system operation.

d. Class I Crane Operator Training. (16-3.d)

(1) Initial. Training duration is a minimum of 24 total hours. The trainer must determine the necessary duration based on the type of equipment, logistics (for example, classroom, outdoors), class size, and other factors. The syllabus must address the applicable ASME B30 requirements for successful completion of written and practical/operational examinations.

(2) Refresher. Conduct refresher training at least once every five years. Recertifications may require more frequent refresher training. Training duration is a minimum of 8 hours total. The trainer must determine the necessary duration based on

the type of equipment, logistics (for example, classroom, outdoors), class size, and other factors. The syllabus must address the applicable ASME B30 requirements for successful completion of written and practical/operational examinations.

e. Class II Crane Operator Training. (16-3.e)

(1) Initial. Training duration is a minimum of 2 hours total. The trainer must determine the necessary duration based on the type of equipment, logistics (for example, classroom, outdoors), class size, and other factors. The syllabus must address the applicable ASME B30 requirements for successful completion of written and practical/operational examinations.

(2) Refresher. Conduct refresher training at least once every five years. Recertifications may require more frequent refresher training. Training duration is a minimum of 1 hour. The trainer must determine the necessary duration based on the type of equipment, logistics (for example, classroom, outdoors), class size, and other factors. The syllabus must address the applicable ASME B30 requirements for successful completion of written and practical/operational examinations.

f. Physical Qualifications/Examination. Operator physical examinations are required every three years or more frequently if their employer deems it necessary. The employer must complete and sign ENG Form 6209 (Certificate of Compliance for Load Handling Equipment and Rigging) (see para 16-10.b) that states that the operator received a physical examination and meets the physical qualifications of the ASME B30.5 standards for the specific type of equipment. Contractors will submit the signed CoC to the KO or COR for acceptance prior to allowing the operator to use the equipment. (16-3.f)

Note. Operators of Class II cranes/hoisting equipment are exempt from the Physical Qualifications Examination requirements, unless this equipment is used to hoist/lift personnel. Hoisting/lifting personnel is a Critical Lift activity and requires a physical examination for the operator. Train all Class II operators hoisting personnel on the specific requirements for hoisting personnel.

Note. LHE maintenance, inspection, and repair personnel covered by paragraph 16-3 are exempt from the crane operator physical requirements identified in this chapter.

g. Government Drug Testing Program. All government employees will follow AR 600-85. (16-3.g)

h. Crane Operator Certification and Qualification Options. The following two options are available for the certification and qualification of crane operators. Contractor must use mandatory ENG Form 6209 (Certificate of Compliance for Load Handling Equipment and Rigging) to designate each operator for the equipment to be used. (See para 16-10.b) (16-3.h)

(1) Crane operators are trained, tested, and certified by a nationally accredited testing organization. If this option is chosen, the employer is still responsible for designating in writing that the operator is qualified to operate a particular type, capacity, and configuration of equipment.

(2) Crane operators are trained, tested, and qualified by a USACE designated in-house crane trainer. If this option is chosen, the employer is still responsible for designating in writing that the operator is qualified to operate a particular type, capacity, and configuration of equipment. Certification and qualification under this option is:

(a) Not portable. Such a certification and qualification is applicable only where the operator is employed by and operates the equipment for USACE.

(b) Is valid for 5 years from date of issuance.

Note. Each USACE activity or operating project must maintain a current list of operators, complete crane and hoisting equipment training records for each operator, and a list of all equipment that each operator is qualified to operate.

i. Signal Person Qualifications. (16-3.i)

(1) A third-party Qualified Evaluator or the employer's Qualified Evaluator/LHE trainer must qualify all signal persons.

(2) For a signal person to be qualified, the evaluator must assess the individual's capabilities and determine and document that they meet the following requirements:

(a) Know and understand the type of signals used (for example, radio, cell, hand). If the signal person uses hand signals, they must know and understand the Standard Method for hand signals.

(b) Be competent in the application of the type of signals used.

(c) Have a basic understanding of crane operation and limitations, including crane dynamics involved in swinging and stopping loads and boom deflection from hoisting loads.

(d) Demonstrate that they meet the requirements through written and practical test that assesses both technical knowledge and hands-on skills.

(3) An assessment by an employer's Qualified Evaluator/LHE trainer is not portable. Other employers are not permitted to use it to meet these requirements.

(4) If subsequent actions by the signal person indicate that the individual does not meet the qualification requirements, the employer may not allow them to work as a

signal person until they are retrained and re-assessed. See also 29 CFR 1926.1428(c) (29 CFR 1926 Subpart CC) Qualification Requirements.

j. Powered Industrial Trucks (PITs)/Telehandlers. Equipment operators, riggers, and others involved in transportation and hoisting operations must have written proof of qualifications. (16-3.j)

k. Operators of excavators used with attachments, such as drill rigs or pile driving equipment, must be trained on the specific operation. (16-3.k)

16-4. Roles and Responsibilities.

a. Employers and supervisors will ensure all LHE operations are conducted according to applicable OSHA, ASME, and USACE requirements: (16-4.a)

b. Competent Person (CP). (16-4.b)

(1) Perform inspections according to paragraph 16-5.

(2) Develop Lift Plans (see para 16-7).

c. Qualified Person (QP). (16-4.c)

(1) Perform inspections according to paragraph 16-5.

(2) Conduct operational tests according to ANSI/ASME B30 and the manufacturer's instructions (see para 16-8.t).

(3) Supervise erection and dismantling of portal, tower, and pillar cranes.

(4) Assist CPs with development of lift plans.

d. Operator Responsibilities. The responsibilities of the operator include, but are not limited to, the following requirements: (16-4.d)

(1) Must communicate effectively with the lift director, rigger(s), signal person(s), and other affected employees onsite.

(2) May not engage in any activity that will divert attention while operating the equipment.

(3) Must not leave the controls while a load is suspended.

(4) Before leaving the LHE unattended, the operator must:

(a) Land any load, bucket, lifting magnet, or other device.

- (b) Disengage the master clutch.
- (c) Set travel, swing, boom brakes, and other locking devices.
- (d) Put the controls in the “OFF” or neutral position.
- (e) Secure the equipment against accidental travel.
- (f) Stop the engine.

(g) Exception. When crane operation is frequently interrupted during a shift and the operator must leave the crane, the operator must follow all of the steps for securing unattended LHE, except for stopping the engine, and must also comply with the following:

(g-1) The CP determines that it is safe to do so;

(g-2) The crane must be located within an area protected from unauthorized entry;

(g-3) The operator remains adjacent to the equipment and not be engaged in any other duties; and

(g-4) The CP implements measures necessary to restrain the boom hoist and telescoping, load, swing, and outrigger functions.

(5) The operator must respond to signals from the person who is directing the lift or an appointed signal person. When a signal person is not used, the operator must ensure a full view of the load and the load travel paths at all times the load is rigged to the equipment.

(6) Each operator is responsible for those operations under their direct control. Whenever the operator is concerned about safety, the operator has the authority and responsibility to stop and refuse to handle loads until a QP has determined that the operation is safe.

e. The operator, qualified lift director and rigger must jointly ensure: (16-4.e)

(1) The LHE is level and, where necessary, blocked.

(2) The load is secured and balanced in the sling or lifting device before it is lifted more than a few inches.

(3) The lift and swing path is clear of obstructions and adequate clearance is maintained from electrical sources according to table 16-1.

(4) All persons are clear of the swing radius of the counterweight and housing.

f. The qualified lift director is responsible for the following when two or more cranes or LHE are used to lift one load: (16-4.f)

(1) Analyzing the operation and instructing all personnel involved in the proper positioning and rigging of the load, and the movements to be made.

(2) Making necessary assessments and determinations for a safe lift, to include crane (LHE) load ratings reductions, load position, boom location, ground support, and speed of movement.

(3) Ensuring that dedicated personnel are present and equipment is functioning properly. All personnel involved with the crane (LHE) operation must understand the communication systems and their individual responsibilities.

16-5. Inspection Requirements.

a. Inspect LHE according to the requirements of this chapter, applicable ASME standards, OSHA regulations, and the manufacturer's instructions. (16-5.a)

b. Maintain records of all LHE tests and inspections onsite. Records must be readily available upon request and, when submitted, they must become part of the official project/contract file. (16-5.b)

c. Contractors must notify the KO or COR within twenty-four hours of any LHE entering the site. The KO or COR may observe the contractor's inspection process and spot check the equipment. (16-5.c)

d. Whenever any LHE is found to be unsafe, or whenever a deficiency that affects the safe operation of the LHE is observed, immediately take the affected LHE out of service and prohibit its use until unsafe conditions have been corrected. (16-5.d)

e. Cranes, Hoists, Derricks, and Other LHE in Regular Service. (16-5.e)

(1) Inspection procedures for LHE in regular service are divided into three general classifications, shift, monthly and annual, based on the intervals at which inspections must be performed.

(2) The intervals depend on the nature of critical components of the LHE and the degree of their exposure to wear, deterioration, or malfunction.

Note. Monthly inspections are required by OSHA. The items to be inspected and the requirements are the same as those covered by the shift inspection. Therefore, monthly inspections will not be addressed separately in paragraph 16-5 and still must be performed.

(a) Shift Inspections. Before every LHE operation, at beginning of each shift, or following a change of operator, a CP must, at a minimum, visually inspect the items according to paragraph 16-5.e(2), applicable ASME standards, OSHA regulations, and the manufacturer's instructions. Do not use the equipment until this inspection demonstrates that no corrective action is required.

(a-1) Document the shift inspection with the results of the inspection, name and signature of the CP who conducted the inspection, and the date of the inspection.

(a-2) Maintain documentation for a minimum of twelve months, or the life of the contract, whichever is longer.

(b) Annual Inspections. Perform inspections at least annually. Perform inspections more frequently if recommended by the manufacturer, or if a load bearing or load controlling part or component has been altered, replaced, or repaired (see para 16-8.s).

Note. Adding/removing counterweights is not considered load controlling/load bearing.

(b-1) A QP must perform the annual inspection and must include operational testing to determine that the equipment as configured in the inspection is functioning properly.

(b-2) Document the inspection with a list of items checked to include findings, the name and signature of the person who conducted the inspection, and the date.

(b-3) Maintain the documentation until at least the next annual inspection, for twelve months, or the duration of the contract, whichever is longer.

(b-4) If any deficiency is identified, a QP must immediately determine whether the deficiency is a safety hazard. If so, then remove the equipment from service until it is corrected. If not a safety hazard, the QP may determine that the employer must monitor daily until the deficiency is corrected.

f. Cranes, Hoists, Derricks, and Other LHE Not in Regular Use. Perform an annual inspection if the equipment has been idle for three or more months. (16-5.f)

g. If LHE is involved in an incident or accident, inspect it according to the manufacturer's instructions. If the manufacturer is no longer available, an RPE must determine the level of inspection required. (16-5.g)

h. Running and Standing Wire Rope Inspection. (16-5.h)

(1) Each Shift. A CP must visually inspect all running ropes, counterweight ropes, and load trolley (standing) ropes according to this chapter, applicable ASME standards, OSHA regulations, and the manufacturer's instructions. Focus the inspection on

identifying apparent deficiencies in wire rope (running and standing). Do not open the wire rope to inspect it. Booming down is not a required part of this inspection.

(a) Document each shift inspection with the results of the inspection, name and signature of the CP who conducted the inspection, and the date of the inspection.

(b) Maintain documentation for a minimum of twelve months or the life of the contract, whichever is longer.

(2) Annual. At least every twelve months, a QP must inspect wire ropes (running and standing) in use on equipment according to this chapter, applicable ASME standards, OSHA regulations, and the manufacturer's instructions. Maintain the same documentation as for shift inspections.

i. Floating Cranes/Derricks, Crane Barges, and Auxiliary Shipboard-Mounted Cranes. In addition to inspecting of the crane/derrick according to paragraph 16-5, a CP must inspect the barge, pontoons, vessel, or other means of flotation used to support a land crane/derrick according to NAA requirements at the following frequencies: (16-5.i)

(1) Each Shift. Inspect the means used to secure/attach the equipment to the vessel/flotation device for proper condition, to include wear, corrosion, loose or missing fasteners, defective welds, water leaks and, where applicable, insufficient tension.

(2) Monthly. In addition to paragraph 16-8.z(18), the vessel/means of flotation used for the following:

(a) Taking on water.

(b) Deck load for proper securing.

(c) Chain lockers, storage, fuel compartments, and battening of hatches for serviceability as a water-tight appliance.

(d) Firefighting and lifesaving equipment in place and functional.

(3) If any deficiency is identified, a QP must immediately determine whether the deficiency constitutes a hazard. If a hazard, remove the vessel/flotation device from service until it has been corrected.

j. Pile Drivers. Inspect the pile driving leads at least weekly and document the findings. If deemed unsafe, or whenever there is an observed safety deficiency, immediately remove the equipment from service and do not use it until the deficiencies have been corrected. (16-5.j)

16-6. Activity Hazard Analysis (AHA) Requirements.

Develop AHAs according to paragraphs 1-6 or 2-6, as applicable. Prepare AHAs for all LHE activities, to include the following:

a. Prior to the start of a specific activity or task, document the crane operator certifications, qualifications, and designations in the AHA. Submit the AHA to the USACE supervisor for approval or acceptance by the KO or COR. (16-6.a)

b. Boom Assembly and Disassembly. Include this operation in the AHA and identify the associated CP. (16-6.b)

c. Portal, Tower, and Pillar Cranes. Before the assembly or disassembly commences, establish the work procedures to ensure site-specific needs are considered and prepare an AHA. The AHA must include the following: (16-6.c)

(1) The location of the crane in relation to other tower cranes, adjacent buildings or towers, overhead power and communication lines, and underground utilities.

(2) Foundation design and construction requirements.

(3) Identify clearances between the tower, the structure, bracing and wedging requirements, when the tower is erected within a structure.

d. Hoisting with Hydraulic Excavating Equipment. Prepare a hoisting operation specific AHA. The AHA must include at least: (16-6.d)

(1) Written proof of qualifications of equipment operators, riggers, and others involved in the hoisting operations.

(2) The specific conditions where other personnel may also operate this equipment, as identified in paragraph 16-3.a.

(3) Operational testing, as described in paragraph 16-8.gg(5).

(4) Proper operating procedures according to the equipment manufacturer's operating manual.

(5) Proper use and onsite availability of manufacturer's load rating capacity charts.

(6) Proper use of rigging, including positive latching devices to secure the load and rigging.

(7) Inspection of rigging.

(8) Use of tag lines to control the load.

(9) Adequate communications.

(10) Establishment of a sufficient swing radius for the equipment, rigging and load.

(11) Stability of surfaces beneath the hydraulic excavating equipment.

16-7. Minimum Plan Requirements.

a. Prior to the start of all crane activities, provide the USACE supervisor/KO or COR with the following documentation for any crane planned for use on a USACE project: (16-7.a)

(1) Detailed description of crane operations.

(2) Personnel required training/qualification (see para 16-3).

(a) Operators proof of qualification (for example, certification, designation letter).

(b) Rigger proof of qualification (for example, certification, designation letter).

(c) Signal Person proof of qualification (for example, certification, designation letter).

(d) Identify who the lift director is.

(3) Completed CoC (see para 16-10.b).

b. Standard Lift Plan (SLP). Plan all lifts to avoid situations where the operator cannot maintain safe control of the lift. Prepare a written SLP for every lift or series of lifts (if duty cycle or routine lifts are being performed). The SLP must be developed, reviewed, and accepted by all personnel involved in the lift. Keep a copy of the SLP on the LHE for the specific approved lift(s). Keep a copy of every SLP for a minimum of three months. Include at least the following in the plan or use the non-mandatory ENG Form 6203 (Crane Standard Lift Plan) (see para 16-10.a): (16-7.b)

(1) Personnel. Roles, responsibilities, qualification, and any public persons or other trade personnel affected by the lift.

(2) Area Preparation. Load handling location and path of travel, blocking/cribbing, overhead lines, ground stability.

(3) LHE Considerations. Capacity, configuration, obstructions, inspection, ground support conditions.

(4) Load Considerations. Weight, CG, radii, and configuration.

(5) Rigging Considerations. Type, configuration (for example, sling and load angle factors), inspection, need for sling protection.

(6) Environmental Considerations. Wind speed, storms, precipitation, power lines in area of travel or load swing, counterweight swing area barricaded.

c. Standard Lift Plan (SLP) - Floating Plant. Plan all lifts to avoid procedures that could result in configurations where the operator cannot maintain safe control of the lift. In addition to the requirements and criteria to be considered in paragraph 16-7.b for ENG Form 6203 (Crane Standard Lift Plan) (see para 16-10.a), supplement with the following requirements and information: (16-7.c)

(1) Lifts must reflect floating operational parameters, such as anticipated boom angles, values for wire leads, unknown load for extractions, and upper limits on crane force.

(2) When deck loads are to be carried while lifting, the situation must be analyzed for modified ratings.

(3) When mounted on barges or pontoons, the manufacturer or QP must modify the rated loads and radii of the land cranes. The QP must evaluate the modifications specific to the flotation device/platform being used.

(4) Post the load charts in the cab or at the operator's station (if no cab) according to paragraph 16-8.z(7). Make readily available on board all other procedures applicable to the operation of the equipment (for example, instructions and operator's manual, recommended operating speeds).

(5) If portable remote controls are used, the procedures to monitor vessel heel and trim and crane machine list and trim.

d. Critical Lift Plan. Before any critical lift, a CP or QP must prepare a Critical Lift Plan and submit it to the USACE supervisor for approval or acceptance by the KO or COR. See non-mandatory ENG Form 6213 (Load-Handling Equipment Crane Operation Critical Lift Plan) (see para 16-10.c). It must include at least the following items, in addition to all of the paragraphs 16-7.a and 16-7.b requirements. (16-7.d)

(1) Detailed description of critical lift to include:

(a) The specific make and model of each piece of LHE, the line, and boom, and the swing speeds.

(b) The exact size and weight of the load to be lifted and all LHE and rigging components that add to the weight. Include the maximum load limits for the entire range of the lift, as listed in the manufacturer's load charts.

(c) The specific lift geometry and procedures for the entire range of the lift. Include the LHE position, height of the lift, the load radius, and the boom length and angle.

(2) The anticipated hazards.

(3) A site drawing that identifies the placement and locations of LHE. Include any adjacent equipment, facilities, utilities, and other site features.

(4) A rigging plan that shows the lift points and describes rigging procedures and hardware requirements.

(5) The applicable LHE Load Chart with equipment serial number.

(6) A description of the ground conditions, outrigger, and crawler track requirements. If applicable, the design of mats necessary to achieve a level, stable foundation of sufficient bearing capacity for the lift. Ground conditions must be adequate for maximum ground pressure exerted by the crane(s).

(7) For floating LHE, a description of the operating base (platform) condition and any potential maximum list/trim.

(8) A list of environmental conditions under which lift operations are to be stopped. Include crane manufacturers requirements.

(9) The coordination and communication requirements for the lift operation.

(10) For tandem LHE lifts, identify the requirements for an equalizer beam if applicable.

e. Pile Driving. Prior to initiating pile driving or extraction operations, the contractor must develop a site-specific safety plan. The plan must identify specific steps for the intended operations, list of hazards, and procedures to minimize or eliminate those hazards. Plans must include at least: (16-7.e)

(1) Location of any above and below grade utilities.

(2) Designated areas for equipment operations and material storage.

(3) Assembly and disassembly sequences for pile driving equipment.

(4) Operation of pile driving equipment and handling of pile materials.

(5) A geotechnical report identifying subsurface and surface conditions.

(6) Daily documented inspections will include: the hammer, cushion blocks, rigging, fuel lines, pressurized hoses, clamps, welds, hardware, and all other pile driving associated equipment.

(7) A controlled work area plan to prevent access by persons not directly involved in the operation.

16-8. General Requirements.

a. The employer must comply with all manufacturer's instructions, procedures, and recommendations applicable to the operational functions of LHE, including LHE use with attachments. Do not exceed the safe operating speeds or loads for the LHE. Where the manufacturer procedures are not available, the employer must develop and ensure compliance with all procedures necessary for the safe operation of the equipment and attachments by preparing: (16-8.a)

(1) QP developed procedures for the operational controls.

(2) An RPE developed and signed procedures related to the capacity of the equipment.

b. When the manufacturer's instructions or recommendations are more stringent than the requirements of this manual, follow the manufacturer's instructions or recommendations. (16-8.b)

c. The use of all electronic equipment not necessary to the work activity being performed is prohibited. (16-8.c)

d. Shut down LHE before refueling. Diesel powered equipment may remain running if a closed system is used that has an automatic shut-off that will prevent spillage if connections are broken. (16-8.d)

e. Before operating the LHE, assess the condition and structure of the road and shoulder to assure that clearances and load capacities are sufficient for the safe passage or placement of any LHE. (16-8.e)

f. All LHE must have the following safety related components, as applicable to the type of equipment: (16-8.f)

(1) An operable fuel gage.

(2) An operable audible warning device (for example, a horn).

(3) Adequate rearview mirror or mirrors.

(4) Non-slip surfaces on steps.

- (5) A power-operated starting device.
 - (6) Seats for the operator and all personnel that are required to be inside or on the equipment.
 - (7) Two functioning headlights and two taillights, whenever visibility warrants additional light.
 - (8) Safety glass in windshields, windows, and doors. Replace cracked or broken glass.
 - (9) At least one dry chemical or carbon dioxide (CO₂) fire extinguisher, with a minimum rating of 10B:C in the cab or at the machinery housing.
 - (10) Back-up alarm for all self-propelled LHE, whether moving alone or in combination (see chapter 18).
 - (11) Warning lights for airfield operations. The lights that are used as collision avoidance measures must comply with the Federal Aviation Administration (FAA) requirements and guidance. (See chapter 32)
- g. Ensure that manufacturer required rollover protective structure is in place and maintained. (16-8.g)
 - h. Follow the manufacturer's specifications and operating manuals for hydraulic equipment and attachments utilizing quick connect/disconnect systems. After completing a switch of attachments, the equipment operator must take the actions necessary to ensure the quick connect/disconnect system is positively engaged. (16-8.h)
 - i. Provide and maintain all required guarding and safety devices as follows: (16-8.i)
 - (1) Guard all belts, gears, shafts, pulleys, sprockets, spindles, drums, flywheels, chains, or other reciprocating, rotating, or moving parts of equipment when exposed to contact by persons or when they otherwise create a hazard.
 - (2) Guard or insulate all hot surfaces of equipment, including exhaust pipes or other lines, to prevent injury and fire.
 - (3) Design, construct, and install required platforms, foot walks, steps, handholds, guardrails, and toe-boards on machinery and equipment to provide safe footing and access ways.
 - j. Work Area Control. When there are accessible areas in which the LHEs permanently or temporarily mounted rotating superstructure poses a risk of striking,

pinching, or crushing an employee against another part of the equipment or another object, the employer must: (16-8.j)

- (1) Prevent personnel from entering these hazardous areas.
- (2) Train employees assigned to work on or near the equipment on the potential hazards.
- (3) Erect and maintain control lines, warning lines, railings, or similar barriers to mark the boundaries of the hazard areas.

Note. Exception. When the employer can demonstrate that it is neither feasible to erect such barriers on the ground nor on the equipment, clearly mark the hazard areas by a combination of warning signs (such as, "Danger-Swing/Crush Zone") and high visibility markings on the equipment that identify the hazard areas. The employer must train each employee to understand what these markings signify.

k. Work Area Access. (16-8.k)

(1) Before an employee goes to location that is out of view of the operator (for example, around rotating superstructure), the employee (or someone instructed by the employee) must inform the operator that they are going to that location. The operator may not rotate the superstructure until the operator is informed, according to a pre-arranged system of communication, that the employee is in a safe position.

(2) Where any part of a crane/derrick is within the working radius of another crane/derrick, the responsible party must institute a system to coordinate operations.

l. Maintenance/Repair of LHE. (16-8.l)

(1) Perform maintenance, including preventive maintenance and repairs, according to the manufacturer's instructions. Make records of maintenance and repairs conducted during the life of a contract available to the USACE supervisor/KO or COR.

(2) Replacement parts or repairs must be of the same kind and quality as the original equipment manufacturer's parts and repairs. Obtain replacement parts for load bearing and other critical parts from the original manufacturer, (if possible) or have them certified by an RPE knowledgeable in LHE.

(3) Shut down all LHE and take positive means taken to prevent its operation while repairs or manual lubrications are being done.

(a) Equipment designed to be serviced while running are exempt from this requirement.

(b) Address control of hazardous energy (LOTO) prior to performing the maintenance and repair of equipment (see chapter 12).

m. Parking. (16-8.m)

(1) Whenever LHE is parked, set the parking brake.

(2) For LHE parked on an incline, chock the wheels or block the track mechanisms, and set the parking brake.

(3) Equip all LHE left unattended at night with lights or reflectors, or place barricades equipped with lights or reflectors. This includes all equipment adjacent to a highway in normal use or adjacent to construction areas where work is in progress.

n. Contractor must notify the KO or COR at least twenty-four hours before any LHE enters the site (prior to inspection/tests) so that the KO or COR can observe the contractor's inspection process and inspect the equipment. (16-8.n)

o. Safety Devices and Operational Aids. Do not use safety devices and operational aids as a substitute for the exercise of professional judgment by the operator. The following safety devices are required on all cranes and derricks covered by this chapter, unless otherwise specified: (16-8.o)

(1) Crane level indicator.

(a) The equipment must have a crane level indicator that is either built into the equipment or is available on the equipment.

(b) Crane level indicators are not required for portal overhead or gantry cranes, derricks, floating cranes/derricks and crane/derricks on barges, pontoons, vessels, or other means of flotation.

(2) Boom stops, except for derricks and hydraulic booms.

(3) Jib stops (if jib is attached), except for derricks.

(4) Equipment with foot pedal brakes must have locks, except for portal and floating cranes.

(5) Hydraulic outrigger jacks must have an integral holding device (check valve).

(6) Equipment on rails must have rail clamps and rail stops, except for portal cranes.

(7) Horn.

p. Proper Operation of Safety Devices. (16-8.p)

(1) Do not begin operations before the safety devices listed in paragraph 16-8.o are in proper working order.

(2) If a safety device stops working properly, then the operator must safely stop operations.

(3) Do not resume operations until the device is again working properly.

(4) Alternative measures may not be used.

q. Operational Aids. Operations may not begin until the listed operational aids are in proper working order, except where the employer meets the specified temporary alternative measures (see exception paragraphs below). More protective alternative measures specified by the crane manufacturer, if any, must be followed. If a listed operational aid stops working properly during operations, the operator must safely stop operations until the temporary alternative measures are implemented, or the device is again working properly. If a replacement part is no longer available, the use of a substitute device that performs the same type of function is permitted and is not considered a modification. (16-8.q)

(1) Category I Operational Aids and Alternative Measures. Repair all malfunctioning operational aids listed in this paragraph no later than seven days after the deficiency occurs.

Note. Exception. If the employer documents that it has ordered the necessary parts within seven days of the occurrence of the deficiency, the repair must be completed within seven days of receipt of the parts.

(a) Boom hoist limiting device. Temporary alternative measures must include at least one of the following:

(a-1) Use a boom angle indicator.

(a-2) Clearly mark the boom hoist cable at a spot that it is visible to the operator and that gives the operator sufficient time to stop the hoist so that the boom stays within the minimum allowable radius. If the operator cannot see the mark, then install mirrors or remote video cameras and displays.

(a-3) Clearly mark the boom hoist cable at a location that is visible to the spotter and that gives the spotter sufficient time to signal the operator to stop the hoist so that the boom stays within the minimum allowable radius.

(b) Luffing jib limiting device. Install a luffing jib limiting device on all equipment with a luffing jib.

(c) Anti-two blocking device (A2B). Install A2B devices at all points of two-blocking.

(c-1) Equip cranes and derricks with an A2B/Hoist-limit device that disengages the function that is causing the two-blocking or install an A2B damage prevention feature (except as noted). A CP must test and certify that the devices are functioning properly prior to operating the crane.

(c-2) Equip lattice boom cranes with an A2B device to stop the load hoisting and boom-down functions before the load block or load contacts the boom tip.

(c-3) Duty Cycle Exception. Lattice boom cranes used exclusively for duty cycle operations are exempt from A2B equipment requirements. When a lattice boom crane engaged in duty cycle work is required to make a non-duty cycle lift (for example, to lift a piece of equipment), it will be exempt from the A2B equipment requirements if the following procedures are implemented: 1) An international orange colored warning device (for example, flag, tape, ball) is properly secured to the hoist line at a distance of 8 feet to 10 feet (2.4 m to 3 m) above the rigging; 2) The signal person acts as a spotter to alert the crane operator with a "STOP" signal when the warning device approaches the boom tip and the crane operator immediately stops the hoisting functions; 3) During a non-duty cycle lift, the signal person does not stand under the load, has no duties other than as a signal person, and complies with the signaling requirements of this manual; and 4) A2B warning devices may be used in lieu of A2B prevention devices for lattice boom crane and hoisting equipment with manually activated friction brakes.

(d) Telescopic boom cranes.

(d-1) Equip telescopic boom cranes with an A2B device to stop the load hoisting function before the load block or load contacts the boom tip, and to prevent damage to the hoist rope or other machine components when extending the boom.

(d-2) Equip telescopic boom cranes used exclusively for duty cycle operations with a two-blocking damage prevention feature or warning device to prevent damage to the hoist rope or other machine components when extending the boom.

(e) Floating cranes. Floating cranes may use an A2B alarm system in lieu of a disengaging device unless they are hoisting personnel.

(f) Other cranes used in duty cycle operations, to include clamshell (grapple), magnet, drop ball, container handling, concrete bucket, pile driving and extracting operations, drilled shaft operations (except telescopic boom cranes), dynamic compaction, and continuous flight auger drilling are exempt from the requirements for A2B devices.

(g) Temporary alternative measure. Clearly mark the cable where it can be easily seen by the operator and that gives the operator sufficient time to stop the hoist to prevent two-blocking. Use a spotter when extending the boom.

(h) Locate the crane mounted wind speed indicating devices where the maximum wind speed can be measured for the lifting activity. Where wind speed and gusts can be effectively measured, a hand-held anemometer may be used.

(2) Category II Operational Aids and Alternative Measures. Repair malfunctioning operational aids listed in this paragraph no later than 30 days after the deficiency occurs.

Note. Exception. If the employer documents that it has ordered the necessary parts within seven days of the occurrence of the deficiency, and the parts are not received in time to complete the repair in 30 days, the repair must be completed with seven days of receipt of the parts.

(a) Boom angle or radius indicator. The equipment must have a boom angle or radius indicator readable from the operator's station unless it is an articulating boom crane or digger derrick manufactured before November 8, 2011. Calibrate and test the indicators following the manufacturer's instructions. An acceptable temporary alternative measure for figuring out the radii or boom angles is to use a measuring device.

(b) Jib angle indicator. Not applicable to articulating boom cranes. Required if the equipment has a luffing jib. An acceptable temporary alternative measure for figuring out the radii or jib angle is to first determine the main boom angle and to then use a measuring device.

(c) Boom length indicator. Not applicable to articulating boom cranes. Required if the equipment has a telescopic boom, except where the load rating is independent of the boom length. An acceptable temporary alternative measure to determine boom length is to use at least one of the following:

(c-1) Mark the boom with measured marks to calculate boom length.

(c-2) Calculate boom length from boom angle and radius measurements.

(c-3) Measure the boom with a measuring device.

(d) Load weighing and similar devices. Not applicable to digger derricks manufactured prior to November 8, 2011. Required if the equipment has any of the following: load weighing device, LMI, rated capacity indicator or rated capacity limiter. Acceptable temporary alternative measures to determine the load weight are to: use a reliable source (that is, load manufacturer), use a reliable calculation method (that is,

calculating a steel beam from measured dimensions and a known unit weight), or use other equally reliable means. Provide the operator with the load weight prior to the lift.

Note. Exception. Overhead and mobile LHE used in duty cycle operations are exempt from the requirements for load indicating devices and LMI devices.

(e) Hoist drum rotation indicator if the drum is not visible from the operator's station. Temporary alternative measures: mark the drum and if needed, install mirrors or remote video cameras and displays if necessary for the operator to see the mark.

(f) Outrigger position (horizontal beam extension) sensor/monitor if the equipment has outriggers (required on equipment manufactured after January 1, 2008). Temporary alternative measure: the operator must verify that the position of the outriggers is correct according to the manufacturer's instructions before beginning operations requiring outrigger deployment.

r. Determining Load. Ensure that the operator has the load information prior to the lift. Determine all loads from one of the following devices or methods: (16-8.r)

- (1) Load weighing device.
- (2) LMI (or rated capacity).
- (3) Load moment (or rated capacity) limiter.

(4) The weight of the load must be determined either from a source recognized by the industry (such as the load manufacturer) or by a calculation method recognized by industry (that is, calculating a steel beam from measured dimensions and a known per foot weight as determine by a QP).

Note. Exception. Permanently installed overhead, gantry, or other cranes that are used to lift gates (for example, spillway, intake, discharge) from slots, have been designed with a reserve capacity and are factory proof tested at 125% of WLL. Load cells are highly recommended, but not required, to determine rigging capacities and overload conditions.

s. General Testing Requirements. The reports must include the test procedures and confirm the adequacy of the repairs or alterations. Keep the test reports with the crane and hoisting equipment or at the onsite project office. (16-8.s)

(1) A QP must conduct operational tests following the applicable ANSI/ASME standard and the manufacturer's instructions. If the manufacturer has no procedures, follow requirements included in this chapter.

- (2) Perform operational testing at the following frequencies:

(a) Before the first use of a new or reinstalled crane or hoisting equipment.

(b) Before using a crane or hoisting equipment after altering, replacing or repairing a load bearing or load controlling part or component, brake, travel component, or clutch (to include securing devices, skids, and barges for floating cranes).

Note. Adding/removing counterweights is not a load controlling/load bearing.

(c) Every time a crane or hoisting equipment is reconfigured or re-assembled after disassembly (to include booms).

(d) Every time a crane and/or hoisting equipment is brought onto a USACE project.

(e) During annual inspections.

Note. When wire rope is replaced, full operational testing of the equipment is not required, but a limited operational test is required prior to putting the equipment back into service.

t. Operational Testing. Operational testing must include the following: (16-8.t)

(1) Load lifting and lowering mechanisms.

(2) Boom lifting and lowering mechanisms.

(3) Boom extension and retraction mechanisms.

(4) Swinging mechanisms.

(5) Travel mechanisms.

(6) Safety devices.

(7) Operational aids.

u. Load Testing. Load testing is considered a critical lift. Develop a Critical Lift Plan following the requirements of paragraph 16-7.d. (16-8.u)

(1) Load tests must be performed under the direction of a QP according to appropriate ASME standards and the manufacturer's instructions. At a minimum, the load test procedures must include the following:

(a) For all cranes. Hoist the test load for a minimum of five minutes to ensure that the load is supported by the crane and held by the hoist brake(s). Lower the test load,

stop lowering, and again hold the load for a minimum of five minutes above the ground with the brake(s).

(b) For mobile cranes, to the extent possible while clearing physical obstructions, operate the crane through the full range of motions below as applicable:

(b-1) Ensure there are no physical restrictions, the full range of its swing, with the test load.

(b-2) Boom the crane up and down within the allowable working radius for the test load. At the maximum radius, hold the load for a minimum of five minutes and ensure there is no movement of the load.

(c) For overhead cranes, to the extent possible while clearing physical obstructions, operate the crane through the full range of motions below as applicable:

(c-1) Travel to the extents of the trolley limits or end stops with the test load.

(c-2) Bridge to the extents of the bridge limits or end stops with the test load.

Note. If the manufacturer is no longer in business and procedures are unavailable, a QP familiar with the type of equipment involved must develop and approve the procedures. Perform load testing according to paragraph 16-8.u.

(2) Weight of test load.

(a) For mobile cranes, the weight of the test load must be 100% to 110% of the anticipated load for the specified configuration. Do not to exceed 100% of the manufacturer's load chart at the configuration of the test. The actual anticipated load may be used as the test load, if approved by the USACE supervisor or accepted by the KO or COR.

(b) For overhead cranes, use the test load weight recommended by the manufacturer.

(3) Perform load testing at the following frequencies:

(a) Before using a crane or hoisting equipment after altering, replacing or repairing a load bearing or load controlling part or component, brake, travel component, or clutch.

Note. Adding/removing counterweights is not considered load controlling/load bearing.

(b) Every time a crane or hoisting equipment(s) is reconfigured or re-assembled after disassembly (to include booms).

Note. Attaching/detaching a jib attachment is not considered “reconfiguring or re-assembling” a crane and so does not require a load test. Install or stow the jib following the manufacturer’s instructions and have a CP document this action prior to operation.

(c) When the manufacture requires load testing.

(c-1) The employer must specifically research, identify and document the manufacturer’s required load-testing frequency for each USACE-owned/operated and/or Contractor owned/ operated crane or hoisting equipment. Provide a copy of this information to the USACE supervisor/KO or COR.

(c-2) Under conditions (a) and (b) above, a selective load test may be performed when the manufacturer requires determination of the weight of test load (that is, testing only those components that have or may have been affected by the alteration, replacement, or repaired).

(c-3) Follow the manufacturer's specifications and limitations applicable to the operation of any crane and hoisting equipment. Do not load a crane or hoisting equipment more than the manufacturer's rated capacity, except overhead and gantry cranes may be loaded up to 125% of the crane load rating for test purposes or planned engineered lifts. (See para 16-7.d and ANSI/ASME B30.2 or B30.16)

(c-4) Where manufacturer's specifications are not available, the limitations assigned to the equipment must be based on the determinations of a registered engineer competent in this field, and such determinations must be documented and recorded.

(c-5) Attachments used with crane and hoisting equipment must not exceed the capacity, rating, or scope recommended by the manufacturer.

(d) Keep all reports that show test procedures and confirm the adequacy of repairs or alterations and provide copies upon request.

v. Operation. (16-8.v)

(1) All LHE must have the following documents with them (in the cab, if applicable) at all times they are to be operated:

(a) The operating manual developed by the manufacturer for the specific make and model of equipment.

(a-1) When not available from a manufacturer, a QP must develop an operation and maintenance manual type document for the LHE. The document must include the

ratings and operating limitations (such as, load charts), recommended operating speeds, special hazard warnings, instructions, and maintenance, testing, and inspection requirements.

(a-2) Where load capacities are available only in electronic format, in the event of a failure which makes the load capacities inaccessible, the operator must immediately cease operations or follow safe shut-down procedures until the operator obtains a useable electronic or hardcopy of the load capacities. A hardcopy of the load capacities must be maintained and available.

(b) The load-rating chart must include:

(b-1) The LHE make and model, serial number, and year of manufacture.

(b-2) Load ratings for all operating configurations, including optional equipment.

(b-3) Recommended reeving for the hoist line.

(b-4) Operating limits in windy or cold weather conditions.

(c) A durable load chart with legible letters and figures must be readily available to the operator at the control station.

(d) Crane logbook. Update the logbook daily as the crane is used. Record the operating hours and all crane inspections, tests, maintenance, and repair events. The operator and supervisor must sign the logbook each day of use. Service mechanics must sign the log after conducting maintenance or repairs on the crane.

(2) Do not make modifications or additions that affect the capacity or safe operation of LHE without the manufacturer's written approval.

(a) If such modifications or changes are made, revise the capacity, operation, and maintenance instruction plates, tags, or decals accordingly.

(b) In no case may the original safety factor of the equipment be reduced.

(3) Install hoisting wire ropes according to ANSI/ASME standards and the equipment manufacturer's instructions.

(a) Overhead and gantry cranes must have at least two full wraps of wire rope on the drums at all times.

(b) All other cranes must have at least two full wraps (that is, not layers) of wire rope on the drums at all times unless the manufacturer's instructions or applicable ASME standards require additional wraps.

(c) The drum end of the wire rope must be anchored to the drum by an arrangement specified by the crane manufacturer.

(4) Communications.

(a) Use a standard signal system with all LHE (that is, by hand, voice, audible or comparable signals).

(a-1) Hand signals may be used when the distance between the operator and signal person is not more than 100 feet (30.5 m). If using hand signals, use the Standard Method.

(a-2) Use a radio or cellphone, or a combination voice/video system when the distance between operator and signal person is more than 100 feet (30.5 m) or when they cannot see each other.

(b) Use a signal person whenever:

(b-1) The operator does not have a clear line of sight to the point of operation, load travel, or area near or at load placement.

(b-2) The equipment is traveling and the view in the direction of travel is obstructed.

(b-3) The operator or the person handling the load determines that it is necessary.

(c) During LHE operations requiring signals, the ability to transmit signals between the operator and signal person must be maintained. If that ability is interrupted at any time, the operator must safely stop operations requiring signals until the signals can be given and understood.

(d) Only one person may communicate with an LHE operator at a time unless an emergency stop signal is given. Anyone may signal an emergency stop and the operator must immediately obey it.

(5) Do not ride on loads, hooks, hammers, buckets, material hoists, or other hoisting equipment not meant for personnel handling of the following actions.

(6) Always use tag lines to control loads unless it is not practical or their use creates a hazard.

(7) Whenever a slack line condition occurs, cease operations and check for the proper seating of the rope in the sheaves and on the drum prior to further use.

(8) Power Line Clearance - Equipment Operations (all voltages). The employer must identify the operating envelope for each LHE. Determine if any part of the LHE,

load line, or load (to include rigging and lifting accessories), if operated up to the equipment's maximum working radius in the operating envelope could get within 20 feet (6.1 m) of the power line. If so, perform at least one of the following:

(a) De-energize and ground. Confirm from the utility owner/operator that the power line has been de-energized and visibly grounded at the work site.

(b) Establish a 20 feet (6.1 m) clearance. Ensure no part of the LHE, load line or load gets closer than 20 feet (6.1 m) to the power line by doing all the following:

(b-1) Conduct a planning meeting with the site/lift director, signal person/rigger, operator, crew, and the other workers who will be in the area. Review location of the power lines and the control measures to prevent encroachment or electrocution.

(b-2) If tag lines are used, they must be non-conductive.

(b-3) Erect and maintain an elevated warning line, barricade, or line of signs in view of the operator. Equip them with flags or similar high-visibility markings at 20 feet (6.1 m) from the power line or at the minimum allowable distance required by table 16-1.

(b-4) Perform at least one of the following additional measures in paragraph (b-5) through (b-8):

(b-5) Use a dedicated spotter who is in continuous contact with the operator. The spotter must have a visual aid to assist in identifying the minimum clearance distance (for example, a clearly visible line painted on the ground). The spotter must stand where they can effectively gauge the clearance distance.

(b-6) Use a proximity alarm set to give operator sufficient warning.

(b-7) Use a device that automatically limits range of movement and is set to prevent encroachment.

(b-8) Use An insulating link/device installed at a point between the end of the load line (or below it) and the load.

(c) Minimum Clearance from Energized Overhead Electric Lines (see table 16-1).

(c-1) Determine the line's voltage and minimum allowable clearance distance using table 16-1.

(c-2) Determine if any part of the equipment, load line, or load in the operating envelope could get closer to the power line than is allowable. If so, implement the 20 feet (6.1 m) clearance control measures in (b) above.

(d) Install permanent overhead and gantry cranes with clearances according to NFPA 70.

(e) When working near transmitter/communication towers where the LHE is close enough for an electrical charge to be induced in the LHE or materials being handled, deenergize the transmitter or provide an electrical ground. Taglines, if used, must be non-conductive.

(f) Assume that all power lines are energized unless the utility owner/operator confirms that the power line has been and will continue to be deenergized and visibly grounded at the work site.

(9) Power Line Safety (over 350 kV). The requirements of paragraphs 16-8.v(8) and 16-8.v(9) apply to power lines over 350 kV except:

(a) For power lines over 350 kV but at or below 1000 kV, substitute “50 feet (15.2 m)” wherever “20 feet (6.1 m)” is specified.

(b) For power lines over 1000 kV, the utility owner/operator or an RPE, who is a QP with electrical power transmission and distribution experience, must establish the minimum clearance distance.

(10) Power line safety while traveling under or near power lines with no load. The employer must:

(a) Lower the boom/mast and its support system enough to meet the allowable clearances in table 16-2.

(b) Evaluate and address the effects of speed and terrain on equipment movement (including boom/mast) to ensure clearances are maintained according to table 16-2.

(c) If any part of the LHE will get closer than 20 feet (6.1 m) to the power line, position a dedicated spotter to be in continuous contact with the operator.

(d) When traveling at night, or in conditions of poor visibility, such as fog, smoke, or precipitation, the employer must:

(d-1) Illuminate the power lines, or use other method(s) to identify the location of power lines.

(d-2) Delineate and follow a safe travel path.

(11) Physical Clearances.

(a) Maintain adequate clearance between moving and rotating structures of the LHE and fixed objects so that employees can move about without harm. The minimum adequate clearance is 24 inches (61 cm).

(b) Barricade the accessible at the rear of the LHEs rotating superstructure areas and within the swing radius of permanently or temporarily mounted items to prevent an employee from being struck or crushed.

(12) Crane Mats. Where crane mats are required for a stable, level work surface for crane operations, the matting material must be in good condition and of adequate thickness, width, and length as to completely support the crane. Place the mats perpendicular to the crane travel path and as close to each other as possible. Use a spotter to guide the crane when it moves on the mat surface to prevent the crane from traveling beyond the limit of the crane mats.

w. Environmental Considerations. (16-8.w)

(1) Do not operate LHE when wind speeds reach the maximum wind velocity based on the surface/load ratio recommendations of the manufacturer.

(a) At winds greater than 20 mph (9 m/s), the operator, rigger, and lift director must cease all crane operations, evaluate conditions, and determine if the lift may proceed. Base this determination on the manufacturer's instructions for calculating wind speed.

(b) Document the decision to proceed or not with the lift in the LHE/crane operator's logbook.

(2) During adverse weather involving icing of the LHE or reduced visibility, operate the LHE at reduced functional speeds and with a signaling means appropriate to the situation.

(3) Stop all LHE operations when lightning is observed. If lightning is within 10 miles, all work stop until 30 minutes after the last thunder or lightning event. Determine how close the lightning is to the operations using a lightning detector. Alternately, once lightning is seen, count the number of seconds until thunder is heard. Divide number of seconds by five to get the distance the lightning is away in miles.

(4) Plan work activities according to the latest weather forecast and be prepared to stop operations until bad weather has safely passed. Document the event and actions taken (for example, in the daily report, crane operator's logbook).

(5) For night operations, provide lighting adequate to illuminate the working areas while not interfering with the operator's vision (see chapter 7).

x. Lattice, Hydraulic, Crawler-, Truck-, Wheel-, and Ringer-Mounted Cranes. (16-8.x)

(1) For required operator aids and indicating devices, see paragraph 16-8.q.

(2) Boom Assembly and Disassembly. Address these activities in the AHA. Identify the CP.

(a) The team must review the manufacturer's procedures before starting the boom assembly or disassembly. The CP must be present during assembly and disassembly operations.

(b) When removing pins or bolts from a boom, workers must stay out from under the boom. Block, crib, or otherwise secure all sections to prevent them from falling.

(c) A CP must confirm, verify, and approve the blocking, cribbing, and other means of securing before assembly and disassembly operations may begin.

(3) Outriggers.

(a) Anytime outriggers are required to be used, except for locomotive cranes, extend or deploy them according to the crane manufacturer's load/capacity chart specifications, except for locomotive cranes.

(b) When partially extended outriggers are used, address the following requirements:

(b-1) Do not operate the LHE with partially extended outriggers unless approved by the crane manufacturer.

(b-2) Set the outriggers at equal positions that correspond to the load/capacity charts supplied by the manufacturer for those positions. Refer only to the load chart(s) corresponding to the outrigger positions that will be used.

(b-3) If outriggers must be set at unequal positions, consult with the manufacturer or QP to determine if the capacity reductions, special operating procedures, or limitations are required.

(c) Securely attach outrigger floats to the outriggers.

(d) Blocking/pads under outrigger floats must meet the following requirements:

(d-1) Have sufficient strength to prevent crushing, bending, or shear failure.

(d-2) Have sufficient thickness, width, and length to completely support the float, transmit the load to the supporting surface, and prevent shifting, toppling, or excessive

settlement under load. Base the blocking area size and thickness on soil conditions, soil type, compaction, liquid limits, underground utilities, crane type and capacity, and having the crane within 1% of level.

(e) Unless the manufacturer has specified an on-rubber rating, mobile cranes must not pick or swing loads over the side of the crane unless the outriggers are down and properly extended.

(4) When not in use, lower the crane booms to ground level or secure them against displacement by wind loads or other outside forces. If the manufacturer recommends against doing this, follow the manufacturer's recommended practice.

(5) When pick and carry operations occur (such as, with Rough Terrain Cranes), center the boom over the front of the crane, engage the mechanical swing lock, and restrain the load from swinging.

y. Portal, Tower, and Pillar Cranes. (16-8.y)

(1) Construct and install all load bearing foundations, supports, and rail tracks according to a design prepared by an RPE. The RPE must be familiar with the specific type of crane.

(2) Assemble and disassemble cranes following the manufacturer's instructions. If manufacturer's procedures are not available, follow the instructions developed by an RPE with knowledge of the specific crane.

(a) When assembled or disassembled, keep the manufacturer's or RPE's instructions and a list of the weights at the site.

(b) A QP must supervise the assembling and disassembling activities.

(c) Prepare and have an AHA approved for the specific assembling or disassembling tasks, before starting the work. See paragraph 16-6.c. for the AHA requirements.

(d) The manufacturer must determine the wind velocity at the site at the time of assembly or disassembly, and evaluate whether it is a limiting factor that could require suspending the work. If the manufacturer's data is not available, then a QP must evaluate any wind loading limitations.

(e) Before assembling any crane components, visually inspect them for damage. Do not assemble dented, bent, torn, gouged, or otherwise damaged members.

(f) Upon assembly and after each climb, plumb the crane and keep it plumbed with wedges or other means. Plumb cranes to the manufacturer's tolerance. Where the

manufacturer does not specify a tolerance, plumb the crane to a tolerance of 1:500 (1 inch:40 feet; 2.5 cm:12.2 m).

(3) Perform pre-operation tests when cranes are assembled and after each climbing operation, and before placing the crane in service. Test all functional motions and motion limiting devices and brakes for proper operation according to the manufacturer's instructions and ASME B30.3 or B30.4, as applicable. Test the:

- (a) Crane supports.
- (b) Brakes and clutches, limit and overload switches, and locking and safety devices.
- (c) Load hoisting and lowering, boom hoisting and lowering, and swing motion mechanisms and procedures.

(4) Climbing Procedures. Prior to and during, all climbing procedures (to include inside and top climbing), the employer must:

- (a) Comply with all manufacturer prohibitions.
- (b) Have an RPE verify that the host structure is strong enough to sustain the forces imposed through the braces, brace anchorages, and supporting floors.
- (c) Ensure that no part of the climbing procedure takes place when wind velocity at the crane superstructure exceeds the lower of the limits set by the manufacturer or a QP. If neither has specified a limit, then the limit is 20 mph (9 m/s) at the crane superstructure. Evaluate wind gusts for their effect on the climbing operation.
- (d) The operator of a hammerhead tower crane must be present during climbing or telescoping operations.

(5) Safety Devices and Operational Aids. Do not begin other work until the operational aids are in proper working order, except where the employer meets the specified temporary alternative measures. In addition to those listed in paragraph 16-8.o, provide the following devices and aids:

Note. The general requirements that are included in paragraph 16-8.o for operational aids do not apply to tower cranes. The devices listed are required on all tower cranes covered by this subpart, unless otherwise specified.

- (a) Rail clamps, if used, must have slack between the point of attachment to the rail and the end fastened to the crane. Do not use rail clamps as a means of restraining tipping of a locomotive crane.
- (b) Hydraulic system pressure limiting device.

(c) The following brakes, which must automatically set in the event of pressure loss or power failure: hoist brake on all hoists, swing brake, trolley brake, and rail travel brake.

(d) Deadman control or forced neutral return control (hand) levers.

(e) Emergency stop switch at the operator's station.

(f) Trolley travel limiting device to prevent the trolley from running into the trolley end stops.

(g) Ambient wind velocity device. Mount the device at or near the top of the crane. Provide a velocity display at the operator's station in the cab. A visible or audible alarm must illuminate or sound in the cab and at remote control stations when a preset wind velocity is exceeded.

(h) Hoist line pull limiting device that limits the lifted load.

(6) Multiple Tower Crane Jobsites. On jobsites where more than one fixed jib (hammerhead) tower crane is installed, locate the cranes so that no crane or its load may come in contact with the structure of another crane. Cranes are permitted to pass over one another.

(7) Weathervaning. Tower cranes required to weathervane when out-of-service must be installed with clearance for boom (jib) and superstructure to swing through a full 360-degree arc without striking any fixed object or other weathervaning crane. The boom must rotate to and in the natural direction of the wind. Follow manufacturer instruction and ASME B30.3.

z. Floating Cranes/Derricks, Crane Barges, and Auxiliary Shipboard-Mounted Cranes. (16-8.z)

(1) The requirements in paragraph 16-8.z are supplemental requirements for floating LHE, pile drivers, drill rigs, man-lifts, and land LHE on barges, pontoons, vessels or other means of flotation and auxiliary shipboard mounted cranes, unless otherwise specified.

(2) Design & Construction Standards. Design and construct the lifting equipment on floating cranes, crane barges, and on ships (shipboard cranes) according to one of the following standards:

(a) ASME B30.8.

(b) ABS Guide for Certification of Cranes.

(c) API Specification 2C.

(3) LHE Manufacturer's Floating Service Load Chart.

(a) Manufacturer's Floating Service Load Chart. A LHE manufacturer's Floating Service Load Chart will be provided. Prepare the Load Chart according to all criteria from the selected standard in paragraph 16-8.z(2).

(a-1) The Floating Service Load Chart must include a table of rated load vs. boom angle and radius.

(a-2) The Floating Service Load Chart must include the maximum allowable machine list and trim associated with the tabular loads and radii provided.

(b) If the manufacturer's Floating Service Load Chart is not available, a qualified RPE may develop a floating service load chart. The Load Chart must:

(b-1) Be developed according to the criteria from the selected standard in paragraph 16-8.z(2).

(b-2) Include a table of rated load vs. boom angle and radius.

(b-3) Include the maximum allowable machine list and machine trim associated with the tabular loads and radii provided.

(b-4) Be approved by an RPE. The RPE must seal and certify (sign) that the NAA meets the requirements of paragraph 16-8.z(3).

(4) Stability During Lift Operations.

(a) The stability of the floating LHE or vessel and shipboard crane must meet the requirements for "lifting" according to 46 CFR 173.005 through 46 CFR 173.025 (46 CFR 173) over the full range of crane slewing angles.

(b) The stability of the floating LHE or vessel and shipboard crane must limit floating platform heel and trim. The list and trim over the full range of LHE slewing angles must be within the limits shown in the LHE Floating Service Load Chart.

(c) Maintain a minimum of 12 inches (30.5 cm) of freeboard over the full range of crane slewing angles.

(d) Submerge the entire bottom area of the floating platform over the full range of crane slewing angles.

(5) Floating Service Naval Architectural Analysis (NAA). An NAA must be provided (see 46 CFR 173).

(a) The NAA must include an evaluation of the LHE on the floating platform. Validate the LHE Manufacturer's Floating Service Load Chart for the following (see para 16-8.z(3)):

(a-1) Stability during lift operation (see para 16-8.z).

(a-2) The machine list and trim limits for afloat service. The Load Chart must be de-rated (reduced) to meet the requirements for stability during lift operation and for machine list and trim limits for afloat service.

(b) The full 360-degree slewing range of the crane, unless specific slewing angle limits are identified.

(c) The deck loading amount, location, deck load CG, and sail area, when deck loads are to be carried while lifting

(d) Wind loading factored into the heel and list calculations. Use a minimum wind speed of 40 mph (18 m/s).

(e) An RPE or Naval Architect/Marine Engineer must seal and certify (sign) that the NAA meets the requirements of paragraph 16-8.z.

(6) Floating Service Structural Analysis.

(a) The floating platform structure must properly support the loads over the full crane slewing range.

(b) For vessels which are not intended for the application, an RPE must evaluate the structural adequacy of the floating platform. Evaluate the weight of the LHE itself and the lift loading developed in the NAA. Include all deck loads and environmental loads in the structural analysis.

(c) Established floating platform structural capacities, such as allowable deck loads, may be used to develop the structural analysis.

(d) An RPE must seal and certify (sign) that the Floating Service Structural Analysis meets the requirements of paragraph 16-8.z.

(e) Reduce the lift amounts developed in the NAA to less than the allowable structural capacity, if the structural analysis shows insufficient structural capacity with the NAA design loads.

(7) Floating Service Load Chart for LHE on Floating Platform. Use both the NAA and Floating Service Structural Analysis to develop the Floating Service Load Chart.

(a) The Floating Service Load Chart must define the lift/radius capacity of the LHE on the specific floating platform.

(b) The Floating Service Load Chart must incorporate any de-ratings required by either the NAA or Floating Service Structural Analysis.

(c) An RPE or Naval Architect/Marine Engineer must seal and certify (sign) that the Floating Service Load Chart meets the requirements of paragraph 16-8.z.

(d) The load chart certification may be either:

(d-1) A floating service load chart developed (de-rated) from the manufacturer's Floating Service Load Chart.

(d-2) If no de-rating is required, the crane manufacturer's Floating Service Load Chart with separate attached certification document.

(e) Submit both the Floating Service Load Chart and the Floating Service Naval Architect Analysis to the USACE supervisor for approval or to the KO or COR for acceptance prior to start of work.

(f) Post the Floating Service Load Chart in the cab or at the operator's station (if no cab). Make all other procedures applicable to the operation of the equipment (for example, instructions and operators manual, recommended operating speeds) readily available on board. The Floating Service Load Chart must include at least the following:

(f-1) Naval Architect's Notes specifying the draft limits, deck cargo weight and vertical CG above deck, maximum wind speed, environmental limits, vessel heel and trim limits, LHE machine list and trim limits, and vessel condition (for example, dry bilges, watertight integrity).

(f-2) The LHE Manufacturer's Floating Service Crane Load Chart.

(f-3) If de-rating of the crane manufacturer's Floating Service Crane Load Chart is required, a separate Floating Service Safe Working Load Chart must be provided with the following mode of operation; table of hook load, boom elevation angle, lift radius (with list/trim considered); maximum machine list and trim; maximum floating platform list and trim; LHE configuration, to include boom length, amount of counterweight, parts of wire, and block size.

(g) The Floating Service Load Chart must be programmed into the crane LMI.

(h) The Floating Service Load Chart must remain valid so long as no major modifications are made to the LHE or to the floating platform, as documented by a QP.

(8) Land the LHE, Derricks and Mobile Auxiliary LHE Mounted on Barges, Pontoons, or Other Means of Flotation.

(a) All requirements in paragraph 16-8.z are applicable for land LHE, derricks and mobile auxiliary LHE mounted on barges, pontoons, or other means of flotation.

(b) LHE Mats. Determine the required need, type, size, and location of LHE mats for the specific type of LHE on the barge.

(c) Provide the proper means of attachment of LHE to prevent shifting during lift operations. Do not use the attachment method to hold down LHE against overturning moment.

(9) LHE Travel.

(a) If traveling is required on the barge with no load, evaluate the travel area during the NAA and include it in the Floating Service Load Chart.

(b) If traveling is required while lifting the load, the lift must be deemed a critical lift. Prepare a Critical Lift Plan according to paragraph 16-7.d.

(c) If traveling is required while lifting the load, ensure that the requirements in paragraph 16-8.z are met throughout the travel range. The NAA and Structural Analysis must cover the travel range with load. Evaluate the travel area during the NAA and include it in the Floating Service Load Chart.

(10) A-Frame Non-Slewing Anchor Handling Barge/Vessel.

(a) An A-Frame Non-Slewing anchor handling barge/vessels may be used for anchor handling low lifting of loads such as, anchor buoys/weights, dredge pipe, submerged pipeline, and pontoons.

Note. If used for any other lifting application, the work platform must be considered a floating derrick and all other requirements of chapter 16 apply.

(b) A-Frame Non-Slewing anchor barge/vessels must also comply with the following:

(b-1) All deck surfaces of the pontoon or barge must be above the water.

(b-2) Provide means for limiting the applied load, such as mechanical means or marking the draft of the barge corresponding to the rated load. Provide the design calculations and test the barge to verify the rated load.

(b-3) Provide a ratchet and pawl for releasing the load from the hoisting machinery brake.

(b-4) Provide the operator with an operating manual and procedures. Train the operator in the anchor handling barge system operations.

(c) If the onboard hoisting equipment is loaded above its intended rating, then use a chain stopper to remove the external load from the A-frame and hoist machinery.

(11) Employer-Made Lift Equipment Used on Barges or Pontoons.

(a) If lift equipment is employer-made, it may not be used until the employer has properly documented that the load charts and applicable parameters for use meet the requirements of one of the standards identified in paragraph 16-8.z.

(b) All requirements in paragraph 16-8.z are applicable.

(12) Modifications.

(a) Weight and CG Changes. Any modifications to the crane and floating platform that change the crane and floating platform lightship characteristics require a new NAA and a new Floating Service Load Chart. Modifications include:

(a-1) An increase in vertical CG by more than 2 inches (5 cm).

(a-2) A change in the lightship displacement by more than 3° (degrees).

(a-3) A shift in longitudinal CG of more than 1° of floating platform length.

(b) Modifications to the crane that result in changes to the crane lift capacity or to the crane machine list and trim limits require a new NAA and a new Floating Service Load Chart.

(13) Overhead Bridge Cranes on Floating Platforms.

(a) An RPE or Naval Architect/Marine Engineer, competent in LHE on floating plant, must perform an overhead bridge crane Naval Architectural Heel and Trim Analysis for overhead bridge cranes on floating platforms.

(a-1) The Analysis must determine the maximum vessel heel and trim that can be generated by use of the bridge crane.

(a-2) The Analysis must cover the full longitudinal and transverse motion range of the bridge crane, the crane weight, and the crane full rated load.

(a-3) If floating platform heel and trim not related to the bridge crane operation is present during the bridge crane operation, include the non-related heel and trim in the Bridge Crane Naval Architectural Heel and Trim Analysis.

(a-4) An RPE or Naval Architect/Marine Engineer must seal and certify (sign) that the Bridge Crane Naval Architectural Heel and Trim meets the analysis requirements.

(b) Bridge Crane Operation at Floating Platform Heel and Trim. The bridge crane manufacturer must verify that the bridge crane may be safely operated at the vessel heel and trim maximums identified by the Bridge Crane NAA.

(c) Floating Platform Heel and Trim Indication. Install a heel and trim indicating device on all bridge crane equipped floating platforms. The bridge crane operator must be able to see the indicating device during the entire bridge crane operation.

(14) Use of Elevating AWP's Onboard Floating Platforms.

(a) Operate the AWP's according to the manufacturer's instructions for service on floating platforms.

(b) AWP's used on floating platforms must have a secondary set of platform controls at ground level.

(c) Do not move AWP's on the platform (driven) during operations with personnel onboard the lift unless it is allowed and addressed in the NAA.

(d) Floating Platform Heel and Trim.

(d-1) When an AWP is used on a floating platform, the floating platform heel and trim must remain within the AWP manufacturer's identified limits for the operation.

(d-2) Properly ballast the floating platform to maintain barge heel and trim within the manufacturer's limits for the AWP operation.

(e) Verification of Floating Platform Heel and Trim.

(e-1) When personnel will be on the AWP, verify the platform heel and trim before any operations.

(e-2) Test the secondary set of platform controls to verify platform heel and trim through the intended range of AWP operations. The test weight must include at least the personnel, materials, tools and equipment involved in each AWP lift.

(f) Operations on Floating Platform During AWP Operation. Do not operate the AWP if the work will affect the floating platform heel and trim beyond the allowable limits.

(15) Safety Devices and Operational Aids. In addition to the requirements of paragraph 16-8.o-q, utilize the following indicators, markings and devices:

(a) Machine heel and trim indicating device. Install this device in the crane cab or at the operator's station (if there is no cab).

(b) Boom angle indicator within clear view of the operator's station.

(c) Floating platform list and trim indicating device as a means for the operator to visually determine the heel and trim of the platform as opposed to the crane.

(d) Draft marks as a means for monitoring both draft and freeboard.

(e) Wind speed and direction indicator located within a clear view of the operator's station.

(f) Anti two-block device (see para 16-8.q).

(16) Portable Remote Controls. If portable remote controls are used for lifting, the operator must do one of the following:

(a) Be directly aware of the vessel heel and trim and the crane machine heel and trim during lift operations.

(b) Be in direct communication with a team member who is directly monitoring vessel heel and trim and the crane machine heel and trim during lift operations.

(17) Inspections. Perform inspections according to paragraph 16-5.l.

(18) Operations.

(a) Operator Lift Planning. Operators must plan lifts in advance, with particular attention to lift radii & boom angle and machine list & trim. Lift planning must address the anticipated range of boom angles, LMI response, and expected LMI warning indicators, if any. (See para 16-7.c)

(b) Operators must monitor the boom tip and the boom angle indicator carefully to ensure that limits of the load chart are not exceeded. The boom angle indicator must respond directly to increasing lift radius resulting from crane trim created by changes to floating platform heel and trim.

(c) Operators should be aware that safety devices such as LMIs do not offer protection from loads generated by relative motions between a floating crane and a fixed object to be lifted. The AHA must address the potential for gross overload and failure mode conditions.

(d) Where portable remote controls are used during lifting, the operator must include procedures to monitor vessel heel and trim and crane machine heel and trim.

(e) Whenever practical, crane use during buoy tending must be limited to lifting the freely suspended buoy clear of the water onto the vessel.

(f) Keep bilges as dry as possible to minimize the adverse effect of free surface (sloshing liquid).

(g) Where crane mats are required for a stable and level work surface for crane operations, the matting material must be in good condition and of adequate thickness, width, and length to completely support the crane. Place the mats perpendicular to the crane travel path and as close to each other as possible. Have a spotter guide the crane when it moves on the mat surface to prevent the crane from traveling off of the crane mats and beyond the NAA limits.

(19) Standard Lift Plan (SLP). Plan all lifts to avoid procedures that could result in configurations where the operator cannot maintain safe control of the lift. Develop an SLP according to paragraph 16-7.c.

aa. Overhead and Gantry Cranes. (16-8.aa)

(1) The requirements in this paragraph 16-8.aa are supplemental requirements for temporary or permanent overhead and gantry cranes. The requirements apply to overhead/bridge cranes, semi gantry, cantilever gantry, wall cranes, storage bridge cranes, and other LHE having the same fundamental characteristics regardless of how it travels (such as, on tracks, wheels), unless otherwise specified.

(2) Assemble all load bearing foundations, anchorages, runways, and rail tracks following the crane manufacturer's instructions and ASME B30.2 or B30.17, as applicable.

(3) Plainly mark the rated load of the crane on each side of the crane.

(a) If the crane has more than one hoisting unit, mark each hoist or each of the load blocks.

(b) Markings on the bridge, trolley, and load block must be legible from the ground or floor.

(4) Warning Device. Except for floor-operated cranes, install an alarm or other effective warning signal on each crane equipped with a power traveling mechanism.

(5) Maintain proper clearance between the crane and any structure or object, any parallel running cranes, and any cranes operating at different elevations.

(6) Make any necessary contact with runway stops or other cranes with extreme care and caution. The operator must do so with particular care for the safety of persons

on or below any of the cranes involved. The operator must be sure that all persons on the other cranes are aware of what is happening.

(7) Operators of outdoor cranes must secure them when leaving.

(8) When the wind-indicating alarm of a cab-operated outdoor crane sounds, stop all crane operations and properly secure and store the crane during the excessive wind conditions.

(9) Signal persons must properly use the applicable hand signals.

bb. Monorails and Under Hung Cranes. (16-8.bb)

(1) Construct and install crane runways, monorail tracks, track supports, and track control devices following the crane manufacturer's instructions and ASME B30.17.

(2) Plainly mark the rated load of the crane on each side of the crane.

(a) If the crane has more than one hoisting unit, mark each hoist or each of the load blocks.

(b) Markings on the bridge, trolley, and load block must be legible from the ground or floor.

(3) Signal persons must properly use the applicable hand signals.

cc. Derricks. (16-8.cc)

(1) For permanent fixed locations, provide the following load anchoring data to the USACE supervisor/KO or COR. For non-permanent installations, this data must be prepared by a QP.

(a) Guy Derricks.

(a-1) Maximum horizontal and vertical forces when handling rated loads with the particular guy slope and spacing stipulated for the application.

(a-2) Maximum horizontal and vertical forces at the guy when handling rated loads with the particular guy slope and spacing stipulated for the application.

(b) Stiffleg Derricks.

(b-1) Maximum horizontal and vertical forces at the mast base when handling rated loads with the particular stiffleg slope and spacing stipulated for the application.

(b-2) Maximum horizontal and vertical forces at the stifflegs when handling rated loads with the particular stiffleg arrangement stipulated for the application.

(2) Derrick booms, load hoists, and swinger mechanisms must be suitable for the derrick work intended and must be anchored to prevent displacement from imposed loads.

(3) When rotating a derrick, avoid sudden starts and stops and limit the rotational speed so that the load does not swing out beyond the radius at which it can be controlled make sure to use tagline(s).

(4) Do not allow the boom and hoisting rope systems to twist.

(5) Notify the operator before handling ropes on a winch head. When a winch head is used, the operator must be within reach of the power unit controls.

(6) When securing the boom, engage the dogs or other positive holding mechanisms on the hoist.

(7) When not in use, the derrick boom must be either:

(a) Laid down;

(b) Secured to a stationary member, as directly under the head as possible, by attaching a sling to the load block;

(c) Lifted to a vertical position and secured to the mast (for guy derricks); or

(d) Secured against a stiffleg (for stiffleg derricks).

dd. Handling Loads Suspended from Rotorcraft (see 1926.551 and FAA requirements). Use hand signals according to ASME B30.12. (16-8.dd)

ee. Powered Industrial Trucks (PITs)/Telehandlers. (16-8. ee)

(1) Do not use this equipment to hoist loads unless allowed by the equipment manufacturer and the manufacturer provides the procedures.

(2) Operations involving the use of PITs to raise personnel and/or using rigging to transport or hoist loads or personnel require different operator skills and considerations than the standard PIT operations performed with this equipment. When PITs are used to transport personnel or hoist loads utilizing hooks, eyes, slings, chains, or other rigging, the following requirements apply:

(a) Follow the procedures included in equipment manufacturer's operating manual.

(b) Equipment operators, riggers, and others involved in the transportation and hoisting operations must provide written proof of qualifications.

(c) Other personnel may also operate this equipment under the specific conditions stated in paragraphs 16-3.a.

(d) Operators must properly use and keep onsite a copy of each manufacturer's load rating capacities or charts for the approved attachments.

ff. Pile Driving Operations. (16-8.ff)

(1) Equip pile drivers with a positive and negative restraint device to prevent accidental hammer disengagement. This prevents the hammer from falling or rising uncontrolled out of the lead and contact with head block or sheaves, if so equipped.

(2) Comply with all manufacturer's instructions, procedures, and recommendations applicable to the operational functions of the equipment, including its use with pile driving attachments. Do not exceed the safe operating speeds or lifting capacity to avoid instability under load. When manufacturer's instructions are not available, the employer must develop and ensure compliance with all procedures necessary for the safe operation of the equipment and attachments.

(a) A QP must develop the procedures for the operational controls.

(b) An RPE must seal and sign the procedures related to the capacity of the equipment.

(3) For LHE pile driving attachments that are used for other than their intended purpose (for example an excavator or forklift modified for pile driving), an RPE must design the attachment. All of the requirements in paragraph 16-8.ff apply.

(4) The operator of this type of equipment must follow the requirements of this manual and must be trained and authorized to operate the pile driving attachment.

(5) Prior to initiating pile driving or extraction operations, the contractor must develop a site-specific safety plan according to paragraph 16-7.e.

(6) With the exception of the pile driver equipment operator (crane/track hoe/forklift), personnel may not stand under the kicker/spotter or directly under, in front of, or closer than 12 feet (3.7 m), or greater if manufacturer specifies, of the pile hammer or pile when the pile is being driven.

(7) Provide the crane/track hoe/forklift operator station protection from falling objects.

(8) Cranes and mechanized equipment used only for pile driving and extracting operations (except telescopic boom cranes), are exempt from the requirements for A2B devices.

(9) Provide guys, outriggers, thrust outs, counter-balances, or rail clamps necessary to maintain stability of the pile-driver rigs.

(10) Pile-Driving Leads.

(a) Assemble pile driving leads using only the approved fasteners and torque values as required by the manufacturer. The leads must be of adequate size, length, and strength to safely accommodate the weight and length of the pile driving hammer, the pile to be driven, and the position (vertical or on a batter) in which they must be used.

(b) Employees may not be on leads or ladders while the pile is being driven.

(c) Do not store anything on the lead landings.

(d) Pile driving leads must have stop blocks to prevent the hammer from being raised against the head block, if so equipped.

(e) Pile driving leads must be free of projections or snags to minimize damage and personnel safety hazards.

(f) Provide a blocking device, capable of supporting the weight of the hammer, for placement in the leads under the hammer at all times while employees are working under the hammer.

Note. Exception. Where it is necessary for an employee to momentarily lean through the leads to guide a pile under the hammer, it is not required that the pile hammer be blocked in the leads.

(g) Inspect the pile driving leads at least weekly. Document the inspection. If the documented findings note any issues or deficiencies that affects the safe use of pile driving leads, then immediately take the equipment out of service and do not use until the unsafe conditions have been corrected.

(h) Swinging leads must have fixed ladders or have bracing configured so that it will function as adequate ladder rungs.

(i) Fixed leads must:

(i-1) Have fixed ladders and, if equipped with decked landings, must have guardrails, intermediate rails, and toe-boards. Install fixed ladders or stairs for access to landings and head blocks.

(i-2) Provide fall protection for any workers exposed to falls of 6 feet (1.8 m) or greater, for work over water, over machinery, or over dangerous operations according to chapter 21. For these cases, install guardrails or personal fall protection systems, to include certified anchorages.

(i-3) Have a crane boom tip connection that is designed by an RPE.

(11) Do not use dogs on pile-driver hoist drums that automatically disengage when the load is relieved or the drum is rotated.

(12) Install guards across the top of the head block to prevent wire from jumping out of the sheaves.

(13) Securely attach all pneumatic or steam hose connections to pile-driver hammers, pile ejectors, or jet pipes with an adequate length of at least one-quarter ($\frac{1}{4}$) inch (0.6 cm) alloy steel chain to prevent whipping if the joint is broken. The chain must have a 3,250 lbs. (1,474.2 kg) WLL and wire of equal strength may be used.

(14) Hydraulic/pneumatic/steam line controls must include two shutoff valves. One valve must be a quick-acting lever type located within easy reach of the hammer operator.

(15) Hoisting and Moving Pile.

(a) Keep all employees clear of the piling that is being hoisted into the leads.

(b) Perform pile hoisting and driving operations using a closed shackle or other positive attachment that will prevent accidental disengagement of the rigging.

(c) Use taglines for controlling unguided piles and free hanging (flying) hammers.

(d) Lower hammers to the bottom of the leads while the pile driver is being moved.

(16) When driving jacked piles, provide access ladders and bulk headed curbs in all access pits, to prevent material from falling into the pit.

(17) When it is necessary to cut off the tops of driven piles, suspend the pile-driving operations, except where the cutting operations are located at least twice the length of the longest pile cut-off from the driver.

(18) Pile Extraction.

(a) If piling cannot be pulled without exceeding the load rating of equipment, use a pile extractor.

(b) When pulling piling, equip the crane with LMI devices, unless the load can be determined and is within the load rating chart of the crane, and unless the booms are not raised more than 60° above the horizontal.

Note. This requirement does not apply to vibrating-type pulling devices.

(c) Do not pull piling by tipping the crane, releasing the load brake momentarily, and catching the load before the crane has settled.

(d) Rigging. When pulling pile, the hook must have the positive locking safety latch. Secure this latch so that rigging gear roll does not occur.

(19) Floating Pile Drivers (see para 16-8.z).

Note. For operations not covered above, see 29 CFR 1926.603.

gg. Hydraulic Excavators and Wheel/Track/Backhoe Loaders Used to Hoist Loads with Rigging. (16-8.gg)

(1) Personnel may not work in, pass under, or ride in the buckets or booms of operating excavators.

(2) Do not use hydraulic excavating equipment to hoist personnel. Personnel may not ride on loads, hooks, hammers, buckets, or any other hydraulic excavating equipment attachment.

(3) Train excavator operators that use attachments (such as drill rigs, pile driving equipment) on the specific attachments and operations before use.

(4) Do not use hydraulic excavating equipment to hoist loads unless allowed by the equipment manufacturer and the manufacturer provides the procedures.

(5) When hydraulic excavating equipment is used to hoist loads utilizing hooks, eyes, slings, chains, or other rigging the following requirements apply:

(a) Operations involving the use of hydraulic excavating equipment and rigging to hoist loads require different operator skills and considerations than the standard excavating operations routinely performed with hydraulic excavating equipment. Prepare an AHA specific to the hoisting operation following the requirements in paragraph 16-6.d.

(b) Perform an operational test with the selected hydraulic excavating equipment. Keep a copy of the operational test report, including the test procedures and results, at the onsite project office.

(b-1) The operational test must demonstrate that the test load and selected rigging can be safely lifted, maneuvered, controlled, stopped, and landed.

(b-2) The operational test must be representative of the complete cycle of the proposed hoisting operation, including configuration, orientation and positioning of the excavating equipment and the use of identical rigging.

(b-3) The test load must be equivalent to the maximum anticipated load but must not exceed 100% of the manufacturer's load rating capacity for the excavating equipment, as configured.

(c) Perform all rigging operations according to chapter 15.

(d) Do not attach hooks, eyes, slings, chains, or other rigging to, or hang them from, the teeth of a bucket during hydraulic excavator load transporting or hoisting operations.

(e) Perform another operational test if repairs, major maintenance, or reconfiguration on the hydraulic excavating equipment or attachments are needed after the completion and acceptance of an operational test described in paragraph 16-8.gg. This additional operational test must demonstrate that the completed repairs are satisfactory and that the test load and selected rigging can be safely lifted, maneuvered, controlled, stopped, and landed.

(6) Lift loads to the minimum height necessary to clear the ground or other obstacles and carry as low as possible when the equipment is traveling.

(7) Do not lift loads over personnel.

(8) Maintain adequate clearances from electrical sources.

hh. LHE-Supported Personnel (Work) Platforms. Do not use LHE to hoist employees, except where the employer demonstrates that the assembly, use, and disassembly of conventional means of reaching the work area (such as, personnel hoist, ladder, stairway, aerial lift, elevating work platform, scaffold) is more hazardous, or is not possible because of the project's physical features or work site conditions. Document this determination in the Critical Lift Plan following the requirements of paragraph 16-7.c. Perform all hoisting of personnel as required in 29 CFR 1926.1431 (29 CFR 1926 Subpart CC). (16-8.hh)

ii. Certificate of Compliance (CoC). Contractors must submit a CoC for each piece of LHE prior to bringing it onsite. Submit the CoC to the USACE supervisor for approval or to the KO or COR for acceptance. (See para 16-10.b). (16-8.ii)

(1) The CoC must state that the LHE and the rigging equipment meets applicable regulations (to include inspections and tests) as required by the manufacturer and the requirements of this manual. A CP for Crane and Rigging must sign the CoC.

(2) Post the CoC on the LHE.

Note. USACE LHE does not require a CoC Form.

16-9. Figures and Tables.

**Table 16-1
Minimum Clearance from Energized Overhead Electric Lines**

Voltage (Nominal, kV, AC)	Minimum Clearance Distance
Up to 50	10 feet (3 m)
51 - 200	15 feet (4.6 m)
201 - 350	20 feet (6.1 m)
351 - 500	25 feet (7.6 m)
501 - 750	35 feet (10.7 m)
751 - 1,000	45 feet (13.7 m)
Over 1,000	As establish by the utility owner/operator or RPE who is a QP with respect to electrical power transmission and distribution.

**Table 16-2
Minimum Clearance Distance from Energized Overhead Electric Lines While Traveling with No Load**

Voltage (Nominal, kV, AC)	Minimum Clearance Distance
Up to 0.75	4 feet (1.2 m)
0.76 - 50	6 feet (1.8 m)
51 - 345	10 feet (3.0 m)
<u>346</u> - 750	16 feet (4.9 m)
751 - 1,000	20 feet (6.1 m)
Over 1,000	As establish by the utility owner/operator or RPE who is a QP with respect to electrical power transmission and distribution.

Note:
Environmental conditions like fog, smoke or precipitation may require increased clearances.

16-10. Checklists and Forms.

- a. ENG Form 6203, Crane Standard Lift Plan (SLP) (non-mandatory)
(https://www.publications.usace.army.mil/LinkClick.aspx?fileticket=qZwLLyJg_bA%3d&t_abid=16438&portalid=76&mid=43543) (16-10.a)
- b. ENG Form 6209, Certificate of Compliance (CoC) for Load Handling Equipment (LHE) and Rigging (mandatory)
(https://www.publications.usace.army.mil/LinkClick.aspx?fileticket=kzvU4YyG1yU%3d&t_abid=16438&portalid=76&mid=43543) (16-10.b)
- c. ENG Form 6213, Load-Handling Equipment Crane Operation Critical Lift Plan (non-mandatory)
(https://www.publications.usace.army.mil/LinkClick.aspx?fileticket=cdmeulZKLQI%3d&t_abid=16438&portalid=76&mid=43543) (16-10.c)

Chapter 17 Demolition, Renovation, and Re-Occupancy

17-1. References.

- a. ANSI/ASSP A10.6, Safety and Health Program Requirements for Demolition Operations (<https://webstore.ansi.org/>) (17-1.a)
- b. ISO 10262, Earth-Moving Machinery – Hydraulic Excavators – Laboratory Tests and Performance Requirements for Operator Protective Guards
(<https://www.iso.org/standards.html>) (17-1.b)
- c. Society of Automotive Engineers (SAE) J1356, Minimum Performance Criteria for Falling Object Guards for Excavators (<https://www.sae.org/standards/>) (17-1.c)
- d. UFGS 01 33 00, Submittal Procedures
(<https://wbdq.org/ffc/dod/unified-facilities-guide-specifications-ufgs>) (17-1.d)
- e. UFGS 02 41 00, Demolition and Deconstruction
(<https://wbdq.org/ffc/dod/unified-facilities-guide-specifications-ufgs>) (17-1.e)
- f. 29 CFR 1926.850, Preparatory Operations
(<https://www.govinfo.gov/content/pkg/CFR-2019-title29-vol8/pdf/CFR-2019-title29-vol8-sec1926-850.pdf>) (17-1.f)

17-2. Definitions.

- a. Competent Person (CP). See paragraphs 1-2 or 2-2, as applicable. (17-2.a)

b. Mechanical Demolition. Structural demolition involving the use of one or more pieces of heavy machinery, to include hydraulic excavators with various attachments, front end loaders (tracked or rubber-tired), cranes, bulldozers, etc. (17-2.b)

c. Qualified Person (QP). See paragraphs 1-2 or 2-2, as applicable. (17-2.c)

d. Registered Professional Engineer (RPE). See paragraphs 1-2 or 2-2, as applicable. (17-2.d)

e. Shoring and Bracing. Temporary support of a building, structure, or trench to provide stability during demolition to decrease the danger of collapse and protect property, workers, and the public. (17-2.e)

f. Soft Demolition. Removal of non-structural parts during renovation activities of a facility or systems within a structure. This includes removal of doors, windows, lay-in tile ceilings, fixtures, interior equipment, lighting, HVAC system components, floor covering, etc. (17-2.f)

g. Structural Demolition. The removal of a structural part of a facility carried out during full structural demolition or renovation activities. This includes buildings, load bearing structures, bridges, chimneys, etc. (17-2.g)

h. Universal Waste. Hazardous wastes that are widely produced by households and many different types of businesses. Universal wastes include televisions, computers, and other electronic devices as well as batteries, fluorescent lamps, mercury thermostats, and other mercury containing equipment, among others. (17-2.h)

17-3. Personnel Required Qualification/Training.

a. All employees engaged in demolition or renovation activities must be instructed in the Demolition Plan so that they can conduct their work activities in a safe manner (see para 17-7). (17-3.a)

b. Load Handling Equipment (LHE) Operators. LHE Operators must be trained and qualified according to chapter 16. (17-3.b)

c. Lead inspectors conducting surveys must meet the training requirements according to paragraph 6-3. (17-3.c)

d. Asbestos inspectors conducting surveys must meet the training requirements according to paragraph 6-3. (17-3.d)

17-4. Roles and Responsibilities.

a. The facility owner is responsible for identifying and field verifying the disconnects to de-energize electrical components and electrical service lines. The

owner must provide written confirmation to the USACE supervisor/KO or COR and the workers performing the work that the equipment and circuits have been de-energized prior to anyone performing work on or near them. (See chapters 11 and 12) (17-4.a)

b. If the project includes fire suppression systems, the owner must provide written confirmation or verification to the USACE supervisor/KO or COR that the Chemical Fire Suppression (CFS) system has been de-activated and that the chemical has been removed from the system, prior to the start of the renovation or demolition process. If the CFS system is found to be active after demolition has begun, immediately cease work and notify the USACE supervisor/KO or COR. Do not abate or remove the CFS system or components without approval by the USACE supervisor or acceptance by KO or COR. (17-4.b)

c. Provide the USACE supervisor/KO or COR with an engineering drawing (for example, site plan, utility plan) that indicates the location of all service lines and the means for their control. (17-4.c)

(1) Confirm that the disconnection or de-energizing has been performed prior to the start of the demolition process.

(2) De-energized electrical service must be secured via a LOTO method and field verified according to the requirements of chapter 12.

17-5. Inspection Requirements.

A CP must conduct inspections throughout demolition to detect hazards resulting from weakened or deteriorated floors, walls, or loosened material. No employee may work where such hazards exist until they are corrected by shoring, bracing, or other means. The frequency of inspections will be identified in the Demolition Plan.

17-6. Activity Hazard Analysis (AHA) Requirements.

Develop AHAs according to paragraphs 1-6 or 2-6, as applicable.

17-7. Minimum Plan Requirements.

Demolition Plan. Demolition Plans are required for all structural or soft demolition activities. The Demolition Plan must be developed and approved by the USACE supervisor or accepted by KO or COR prior to work. The plan will be based on the engineering, lead, and asbestos surveys and must detail procedures for safe dismantling and removal of all building components and debris.

a. Structural Demolition Plans must be developed by an RPE. (17-7.a)

b. Soft Demolition Plans may be developed by a QP in lieu of an RPE. (17-7.b)

c. Plans must include the following: (17-7.c)

(1) Detailed description of the activity being performed.

(2) Description of anticipated hazards or concerns and the control measures that will be implemented to control to an acceptable level.

(3) Assignment of personnel and their roles and responsibilities. Include necessary information/documentation to support qualification/training of such persons. (See para 17-3).

(4) Inspection frequency and oversight methods to ensure adherence to the plan.

(5) Schedule.

(6) Description of work methods and equipment to be used.

(7) Site preparation.

(8) Waste Management Plan to include ACM/Other Regulated Material (ORM) Abatement Plan (see para 17-8.i).

(9) Site Restoration Plan.

(10) Surveys (see para 17-8.b).

(11) Means of access (see para 17-8.c).

(12) Other requirements specified in the contract/task order.

17-8. General Requirements.

a. Perform demolition and renovation activities according to ANSI/ASSP A10.6. (17-8.a)

b. Surveys. Prepare the following surveys prior to initiating demolition or renovation activities and include them in the Demolition Plan. (17-8.b)

(1) Lead, Asbestos, and Other Regulated Material (ORM) Surveys. Surveys must be performed by trained and licensed inspectors according to chapter 6. Ensure applicable OSHA and EPA requirements for surveys are followed (see para 17-3). See also the additional lead and asbestos requirements in chapter 6.

(2) Engineering Survey. A RPE must perform an engineering survey of the structure to be demolished and any adjacent structures where employees or property may be exposed to determine the following:

(a) Structure layout.

(b) The condition of the framing, floors, and walls.

(c) The possibility of unplanned collapse of any portion of the structure.

(d) The existence of other demolition hazards.

(e) If any hazardous building materials, hazardous chemicals, gases, explosives, flammable materials, or dangerous substances have been used in any building construction, pipes, tanks, or other equipment on the property.

(e-1) When such hazards are identified, conduct testing to determine the type and concentration of the hazardous substance. Provide the test results to the USACE supervisor/KO or COR and the contractor's designated authority.

(e-2) Control or eliminate such hazards before demolition is started.

(e-3) If HAZMAT are found on the project site or location after demolition started, immediately cease work and notify the USACE supervisor/KO or COR. Do not abate or remove the HAZMAT without USACE supervisor approval or KO or COR acceptance.

Note. An engineering survey is not required for soft demolition activities as long as no load-bearing structure will be removed or demolished.

c. Demolition Preparatory Actions. (17-8.c)

(1) All ACM and ORMs must be removed from structures according to all federal and state laws before renovation/demolition begins.

Note. For the context of this chapter, ORM refers to any other regulated HAZMAT not otherwise specifically called out by name within the text of this chapter.

(2) When employees work within a structure to be demolished that has been damaged by fire, flood, explosion, or other cause, the walls and/or floor must be shored or braced according to the engineering survey and Demolition Plan (see paras 17-7 and 17-8.a).

(3) Electric, gas, water, steam, sewer, and other service lines affected as a result of project work must be shut off, capped, or otherwise controlled inside and outside the building line before demolition is started.

(a) In each case, notify the responsible utility companies in advance of the termination.

(b) If it is necessary to maintain any power, water, or other utilities during renovation, temporarily relocate and protect such lines.

(4) If the project includes the abandonment or demolition of existing gas lines, ensure that the existing lines are accurately located and the procedures for removal,

installation, or relocation of lines are accomplished according to the applicable requirements of 29 CFR 1926.850.

(5) Evaluate and control potential hazards from fragmentation of glass inside and outside of the demolition site.

(6) Protect employee entrances to multistory structures with sidewalk sheds, canopies, or both.

(a) Provide protection for a minimum distance of 8 feet (2.4 m) from the face of the building.

(b) All canopies must be at least 2 feet (0.6 m) wider than the building entrances or openings (1 foot (0.3 m) wider on each side) and must support a load of 150 psi (1,034.2 kPa).

(7) Identify the designated means of access and the no-entry access points in the Demolition Plan. Close, barricade, and install appropriate signage at all no-entry access points. Install appropriate signage at all access points.

(a) Only use the stairways, passageways, and ladders that are specifically designated as means of access to the structure.

(b) Cover stairwells to protect workers from falling debris at a point no less than two floors below the floor on which work is being performed.

(c) Provide access to floors where work is in progress through a separate, lighted, and protected passageway.

(8) Dust Control. Take protective measures to control the accumulation and migration of dust and dirt during demolition activities. This includes preventative steps to limit the spread of dust and debris to occupied portions of a building and to avoid the creation of a nuisance or hazardous dust in the surrounding area.

d. Demolition. (17-8.d)

(1) Ensure dust generated from demolition activities is adequately controlled according to applicable requirements.

Note. Regulatory requirements for the control of dust generated during demolition operations can arise from local, county, state, and federal ordinances, codes and/or regulations. Work closely with local and state environmental regulator, as well as with any office that issues a demolition permit (if in an area where such permits are required), to ensure the requirements for the control of dust that exist are met.

(2) Demolition or removal of a facility may also include appurtenances to the primary structure. These appurtenances might include fences, parking areas and associated lights, roadways and access from roadways, sidewalks and stairs associated with access., pads, patios, and paved lay-down areas, utilities, underground and above ground storage tanks, poles, and interior and exterior equipment associated with the facility.

(3) Before structural demolition can begin, abatement of lead, asbestos, and ORM must be completed.

(4) Once structural demolition has begun, personnel must not work inside the structure.

(5) Do not permit masonry walls, or sections of masonry, to fall upon the floors of the building in such masses as to exceed the safe carrying capacities of the floors.

(6) Wall sections that are more than 6 feet (1.8 m) in height must be laterally braced unless the wall was designed and constructed to stand without any lateral support and is self-supporting. Do not leave wall sections left standing without lateral bracing any longer than necessary for removal of adjacent debris interfering with demolition of the wall.

(7) Do not work on top of walls when weather constitutes a hazard.

(8) Do not cut or remove structural or load-supporting members on a floor until all stories above the floor have been demolished and removed. If necessary, floor beams may be cut for material disposal or equipment installation provided the structural bracing and other requirements of this chapter are followed.

(9) Plank solid floor openings within 10 feet (3 m) of any wall being demolished, except when employees are kept out of the area below.

(10) In buildings of skeleton-steel construction, the steel framing may be left in place during the demolition of masonry. Clear all steel beams, girders, and structural supports of loose material as the masonry demolition progresses downward.

(11) Do not demolish walls that serve as retaining walls to support earth or adjoining structures until the earth is braced or adjoining structures are underpinned.

(12) Do not use walls to retain debris unless capable of safely supporting the imposed load.

e. Floor Removal. (17-8.e)

(1) Before demolishing any floor, remove debris and other materials from the immediate work location and other adjacent floor areas.

(2) While breaking down floor areas between beams and joists, employees must work upon planks that are not less than 2 inches x 10 inches (5 cm x 25.4 cm) in actual cross section.

(a) Locate the planks to provide a safe support for personnel should the joists between the beams collapse.

(b) Do not exceed 16 inches (40.6 cm) straddle space between planks.

(c) Provide walkways that are at least 18 inches (45.7 cm) wide formed of wood planks that are at least 2 inches (5 cm) thick, or of equivalent strength, to be used by personnel to reach points so they do not walk upon exposed beams.

(d) Support flooring planks with stringers. Support the ends of the stringers with the floor beams or girders.

(e) Lay the planks together over solid bearings with the ends overlapping at least 1 foot (0.6 m).

(3) Do not allow workers in the area directly underneath the area where a floor is being removed. Barricade these areas to prevent access and post signs to warn of the hazard.

f. Steel Removal. (17-8.f)

(1) When any portion of a floor has been removed, provide planking to support the workers razing or dismantling the steel framing-

(2) Dismantle skeleton-steel construction column-by-column and tier-by-tier. Columns may be in two-story lengths.

(3) Do not overstress any structural member during dismemberment.

g. Mechanical Demolition. (17-8.g)

(1) All mechanical equipment used on a project must meet the applicable requirements of this manual and OSHA regulations.

(2) Install top and front guards on excavators directly involved in demolition of free-standing buildings or structures that are higher than the top of the excavator cab according to SAE J1356 or ISO 10262 Level II standards.

(3) No one may occupy an area where mechanical demolition is being performed unless they are necessary for the performance of the operations.

(4) Use dust abatement measures to suppress dust during demolition.

(5) Use respiratory protection as necessary to protect personnel from respiratory hazards, including equipment operators (see chapter 5).

(6) A wrecking ball may only be used if approved by the USACE supervisor or accepted by the KO or COR. If a wrecking ball is approved/accepted for a demolition, the following must be adhered to:

(a) The weight of the wrecking ball must not exceed 50% of the crane's rated load, based on the length of the boom and the maximum angle of operation, or 25% of the nominal breaking strength of the suspension load line, whichever is less.

(b) The crane boom and load line must be as short as possible.

(c) The ball must be attached to the load line with a swivel-type connection to prevent twisting of the load line and must be attached by positive means so that the weight cannot be accidentally disconnected.

(7) Do not use mechanical equipment on floors or on working surfaces unless they have sufficient strength to support the loads.

h. Work Progression. (17-8.h)

(1) Begin demolition of floors and exterior walls at the top of the structure and proceed downward, except when cutting holes in floors for chutes or holes through which to drop materials, creating storage space, or performing similar preparatory work.

(2) Remove each story of exterior wall and floor construction and move it into the storage space before working on the next story below.

(3) Do not allow walls or sections of masonry to fall upon the floors in such masses that exceed the safe carrying capacities of the floors.

i. Debris Removal, Disposal, and Waste Management. (17-8.i)

(1) Construct and use chutes used for debris removal according to chapter 14. Install a guardrail system according to chapter 21 completely around chute openings at the working level that personnel stand to dump material. Cover any space between the chute and the edge of openings in the floors through which it passes.

(2) When debris is dropped without chutes through openings in the floors, enclose the openings with a guardrail system according to chapter 21. Enclose the area onto which the material is dropped with a guardrail system located at least 6 feet (1.8 m) back from the projected edge of the opening above.

(a) Post warning signs that address the hazard of falling materials at each side of the debris opening on each floor.

(b) Do not remove debris from an area until all debris removal and handling cease on the upper floors.

(3) Enclose all material chutes, or sections thereof, at an angle of more than 45° from the horizontal, except for openings equipped with closures at or about floor level for the insertion of materials.

(a) Openings must not exceed 48 inches (121.9 cm) in height measured along the wall of the chute.

(b) Close and secure all openings, except for the top opening, when not in use.

(4) Install a substantial gate inside each chute at or near the discharge end. A CP must control the operation of the gate and the backing and loading of trucks.

(5) Close off the area near the discharge end of a chute except during loading operations.

(6) Where material is dumped from mechanical equipment or wheelbarrows, attach a toe board or bumper, not less than 4 inches (10.2 cm) thick and 6 inches (15.2 cm) high, at each chute opening.

(7) Design and construct chutes with enough strength and durability to eliminate failures resulting from the impact of the falling materials and debris.

(8) Do not exceed the allowable floor load when storing materials, universal waste, and debris on any floor of a structure.

(9) In buildings having wood floor construction, only remove floor joists from one floor above grade to create a storage space for debris, provided falling material is not permitted to endanger the stability of the structure.

(a) When wood floor beams serve to brace interior walls or freestanding exterior walls, leave the beams in place until other support can be installed to replace them.

(b) Floor arches located no higher than 25 feet (7.6 m) above grade may be removed to create a storage area for debris, as long as their removal does not endanger the stability of the structure.

(c) Block off all storage spaces where materials are dumped into them. Keep these areas closed except when removing the materials.

(d) Install curbs or stop logs around all floor openings to prevent equipment from running over the edge.

(e) Do not cut openings in a floor for the disposal of materials longer in size than 25% of the aggregate of the total floor area unless the lateral supports of the removed flooring remain in place. Shore floors weakened or otherwise made unsafe by demolition to carry safely the intended imposed load for demolition.

(10) Remove all demolition debris and other existing wastes within the limits of work and dispose offsite according to the Waste Management Plan (see para 17-7). Separate the debris according to the planned disposal type. Dispose of all material to include ACM and ORM according to applicable laws and regulations.

(11) The USACE supervisor will approve or the KO or COR will accept the disposal sites, whether Government furnished, private, or commercial, during review of the Waste Management Plan. Provide the USACE supervisor/KO or COR with documentation that confirms the actual disposal locations, the type of debris, and quantities of each type to include any wastewater generated during dust suppression.

(12) Transport lead, ACM and ORM to a controlled landfill or other licensed disposal facility.

(13) Transport construction and demolition (C&D) debris to a solid waste landfill.

(14) Transport recyclable C&D materials to a recycle yard or set them aside for Government use.

17-9. Figures and Tables.

Not Applicable.

17-10. Checklists and Forms.

Not Applicable.

Chapter 18

Vehicles, Machinery, and Mechanized Equipment

18-1. References.

a. ANSI/Industrial Truck Standards Development Foundation (ITSDF) B56.1, Safety Standard for Low Lift and High Lift Trucks (<https://webstore.ansi.org/>) (18-1.a)

b. SAE J1042, Operator Protection for General-Purpose Industrial Machines (<https://www.sae.org/standards/>) (18-1.b)

c. SAE J167, Overhead Protection for Agricultural Tractors- Test Procedures and Performance Requirements (<https://www.sae.org/standards/>) (18-1.c)

- d. SAE J386, Operator Restraint System for Off-Road Work Machines (<https://www.sae.org/standards/>) (18-1.d)
- e. SAE J1194, Rollover Protective Structures (ROPS) for Wheeled Agricultural Tractors (<https://www.sae.org/standards/>) (18-1.e)
- f. 29 CFR 1910.178, Powered Industrial Trucks (<https://www.govinfo.gov/content/pkg/CFR-2020-title29-vol5/pdf/CFR-2020-title29-vol5-sec1910-178.pdf>) (18-1.f)
- g. 49 CFR 571, Federal Motor Vehicle Safety Standards (<https://www.govinfo.gov/content/pkg/CFR-2020-title49-vol6/pdf/CFR-2020-title49-vol6-part571.pdf>) (18-1.g)

18-2. Definitions.

- a. All-Terrain Vehicle (ATV). Recreational-type vehicles intended for off-road use that travel on four low pressure tires with a seat designed to be straddled by the operator. (18-2.a)
- b. Drilling Equipment. Mechanized equipment used for boring into rock, soil, or concrete. (18-2.b)
- c. Government-Owned Motor Vehicle. Any motor vehicle that is government owned or leased by USACE (for example, General Services Administration fleet vehicles). Personally owned vehicles or temporary duty rental cars being used while on-duty to transport Government employees for official business. (18-2.c)
- d. Machinery and Mechanized Equipment. Mobile, stationary, self-propelled, or towed equipment intended for use on construction sites or industrial sites. This equipment is not intended for operation on public highways. (18-2.d)
- e. Motorcycle. A motor vehicle with motive power having a seat or saddle for the use of the rider and designed to travel on not more than three wheels in contact with the ground. (18-2.e)
- f. Motor Vehicle. A sedan, van, sport utility vehicle, truck, motorcycle, or other mode of conveyance intended for use on public roadways. This includes construction equipment that is driven on public highways. (18-2.f)
- g. Snow Machine. Any vehicle designed to travel over ice and snow using mechanical propulsion in conjunction with skis, belts, cleats, or low-pressure tires. (18-2.g)

h. Specialty Vehicle. All other vehicles not meeting any of the vehicle, machine, or equipment definitions in this chapter and may include cargo or personnel carriers or custom. (18-2.h)

i. Utility-Terrain Vehicle (UTV). Vehicles designed to perform off-road utility tasks such as passenger and cargo transportation with side-by-side seating. (18-2.i)

18-3. Personnel Required Qualification/Training.

a. Every person operating machinery and mechanized equipment, drilling equipment, ATVs, UTVs, or specialty vehicles must be properly trained, qualified by license, certificate, or permit, and designated by the employer in writing to operate such equipment. (18-3.a)

b. Every operator of a motor vehicle, machinery and mechanized equipment, drilling equipment, ATV, UTVs, or specialty vehicles, must possess, at all times while operating such vehicle or equipment, a current, non-expired license or permit (proof of qualification) valid for the equipment being operated. Licensing requirements are specified in the applicable Service regulation for military personnel and state regulations for civilian personnel, to include contractors. The operator must present the license or permit to the USACE supervisor/KO or COR upon request. Failure to do so will result in the immediate prohibition of the operator to operate the vehicle, machinery, or equipment. (18-3.b)

(1) USACE Operators. In lieu of a license or permit for each piece of equipment, a DA Form 348 (Equipment Operator's Qualification Record (Except Aircraft)) (see para 18-10.a), or similar type of documentation, may be maintained on file at the employee's project office for all USACE equipment operators.

(2) Government Personnel Operators. Follow local installation requirements. They may require OF 346 (U.S. Government Motor Vehicle Operator's Identification Card) (see para 18-10.b), on military bases in addition or in lieu of a state driver's license.

c. Every operator of a motor vehicle, machinery and mechanized equipment, drilling equipment, ATV, UTVs, or specialty vehicles must be able to read and understand the signs, signals, and operating instructions in use. (18-3.c)

d. Defensive Driving. The principles of defensive driving must be practiced. Government and contractor operators of government motor vehicles (see para 18-2.c) must complete four hours of defensive driver training in every four-year period. Training must include an initial training with a minimum duration of 2 hours. Contractor operators of government-owned motor vehicles must provide documentation of completion of a defensive driving course meeting this requirement to the local SOHO/USACE supervisor/KO or COR initially and upon request. (18-3.d)

e. Machinery and Mechanized Equipment. Equipment operators must be trained and evaluated by persons who have the applicable and appropriate knowledge training and experience. (18-3.e)

(1) Examiners must be independently certified (that is, they cannot train and evaluate themselves).

(2) All qualification/licensing of equipment operators by examiners must include, at a minimum, the requirements of this chapter, the manufacturer's instructions and recommendations, as well as observation of a practical operating examination on the equipment.

f. Powered Industrial Trucks (PITs). Train operators according to 29 CFR 1910.178, including both classroom and practical operation. Employees must be trained on the same type of truck they will be expected to use on the job. (18-3.f)

(1) The employer must certify that the operator has been trained and evaluated as required by the standard. The certification must include the name of the operator, the date of the training, the date of the evaluation, and the identity of the person(s) performing the training or evaluation.

(2) Refresher training in relevant topics must be conducted at least once every three years, including an evaluation of each PIT operator's performance. In addition, refresher training must be provided when any of the following conditions exist:

(a) The operator has been observed to operate the vehicle in an unsafe manner.

(b) The operator has been involved in an accident or near miss.

(c) The operator has received an evaluation that reveals that the operator is not operating the PIT safely.

(d) The operator is assigned to drive a different type of PIT.

(e) A condition in the workplace changes in a manner that could affect safe operation of the PIT.

g. All-Terrain Vehicles (ATVs). Operators must complete an accredited ATV training course (for example, Specialty Vehicles Institute of America, by in-house resources that have been certified as trainers by an accredited organization) prior to operation of the vehicle. (18-3.g)

Note. If in-house trainers are used, they must be certified by an accredited organization. They must perform at least one training session every three years to maintain certification. If the accrediting agency requires the trainer to return for

refresher training to maintain certification, this requirement is in addition to the training session taught every three years.

h. Utility-Terrain Vehicles (UTVs). Operators must be familiar with the use of all controls and understand proper moving, stopping, turning, and other operating characteristics of the vehicle. Operators must review all training materials provided by the manufacturer and be trained according to the manufacturer's instructions to include the following: (18-3.h)

- (1) Basic riding tips from the manufacturer's published literature for each vehicle.
- (2) Reading terrain.
- (3) Climbing hilly terrain.
- (4) Descending a hill.
- (5) Traversing a slope.
- (6) Riding through water.
- (7) Cargo carriers and accessories.
- (8) Loading and unloading.
- (9) Troubleshooting.
- (10) Proper preventative maintenance (for example, oil levels, tire pressure requirements, and scheduled maintenance requirements according to the manufacturer's guidelines).

i. Specialty Vehicles. Establish a driver qualification and training program specific to each specialty vehicle. (18-3.i)

j. Snow Machines. Operators of snow machines must be trained in the following: (18-3.j)

- (1) Hand signals.
- (2) Riding positions.
- (3) Towing of a sled.
- (4) Surface conditions and types (for example, snow, ice, tundra).
- (5) Proper riding apparel.

(6) Dangers to avoid.

18-4. Roles and Responsibilities.

a. Competent Person (CP). (18-4.a)

(1) Inspect vehicles and machinery and mechanized equipment according to the manufacturer's requirements and this manual (see para 21-5.b).

(2) Conduct and document required risk assessments for drilling operations (see para 18-8.k).

b. Vehicle and Equipment Operators. Conduct pre-use inspections (see para 18-5.a). (18-4.b)

c. Qualified Person (QP). (18-4.c)

(1) Test, maintain, and repair vehicles and machinery and mechanized equipment according to the manufacturer's instructions (see paras 18-5.a and 18-8.a).

(2) Evaluate all equipment placed or operating on barges, pontoons, vessels, or other means of floatation for safe placement, transport, and operating conditions (see para 18-8.j).

d. Qualified Mechanic. Inspect vehicles and machinery and mechanized equipment prior to initial use (see para 21-5.a). (18-4.d)

18-5. Inspection Requirements.

a. General Inspections. (18-5.a)

(1) Inspect, test, maintain, and repair all vehicles and machinery and equipment under a scheduled maintenance program according to the manufacturer's instructions. Maintenance programs must be conducted by a QP.

(2) A qualified mechanic (as required by the equipment manufacturer) must inspect all vehicles and machinery and mechanized equipment not otherwise inspected by state or local authorities before initial use. The items must be in a safe operating condition and in compliance with all required published vehicle safety standards. Maintain this one-time inspection report available at the work site.

(3) Inspect dump trucks brought onto USACE job and project sites. The dump trucks must be in compliance with the requirements of paragraph 18-8.h before they are placed in service and document this inspection.

(4) Prior to each use, but not more often than once each day or each shift, vehicles and machinery and mechanized equipment must be checked by the operator to assure that the following parts, equipment, and accessories are in safe operating condition and free of apparent damage that could cause failure while in use:

- (a) Service brakes, including trailer brake connections.
- (b) Parking system (hand brake).
- (c) Emergency stopping system.
- (d) Tires.
- (e) Horns.
- (f) Steering mechanism.
- (g) Coupling devices.
- (h) Seat belts.
- (i) Operating controls.
- (j) Safety devices (for example, back-up alarms and lights, fire extinguishers, first-aid kits).
- (k) Accessories including lights, reflectors, windshield wipers, and defrosters where such equipment is necessary.

(5) Maintain inspection, test, repair, and maintenance records at the site and make them available, on request, to the USACE supervisor/KO or COR.

b. Machinery and Mechanized Equipment. (18-5.b)

(1) Prior to being placed into use, machinery and mechanized equipment must be inspected by a CP. Inspections must be documented on either a manufacturer, government-supplied, or contractor generated checklist, and signed by the CP designating that the equipment meets the manufacturer's recommendations and the requirements of this manual.

(a) Submit the checklist to the USACE supervisor/KO or COR upon completion of an inspection and include it in the project file.

(b) Correct all safety deficiencies noted during the inspection prior to placing the equipment back in service.

(c) Conduct subsequent re-inspections at least annually. Any time the machinery or mechanized equipment is removed and subsequently returned to the project (other than equipment removed for routine off-site operations as part of the project), it must be re-inspected and recertified prior to use.

(d) Contractors must provide the KO or COR ample notice in advance of any equipment entering the site so that the contractor's inspection process may be observed and spot checks may be conducted.

(2) Inspect all machinery and mechanized equipment daily (when in use) to ensure safe operating conditions. Inspections must be conducted by a CP and documented to include, the date, name of the inspector, specific items inspected, and a "PASS/FAIL" indication. Provide copies of the inspections to the USACE supervisor/KO or COR upon request.

c. Road and Shoulders. Perform inspections or determinations of road and shoulder conditions and structures in advance to assure clearances and load capacities are safe for the passage or placing of any machinery and mechanized equipment. (18-5.c)

18-6. Activity Hazard Analysis (AHA) Requirements.

Develop AHAs according to paragraphs 1-6 or 2-6, as applicable, to include the following:

a. Drilling Equipment. Develop an AHA prior to initiating rock, soil, or concrete drilling operations. The AHA must include: (18-6.a)

- (1) Location of all overhead electrical lines/hazards.
- (2) Location of any possible UXO or hazardous agents in the soil.
- (3) Location of utilities both above and below grade.
- (4) Designated areas for equipment operations and material storage.
- (5) Assembly and disassembly sequences for the drilling equipment.
- (6) Operation of the drilling equipment and handling of associated materials.
- (7) If available, a geotechnical survey report identifying subsurface and surface ground condition.
- (8) A hard copy of the SDS for any drilling fluids (see chapter 6).
- (9) Risk assessments according to paragraph 18-8.k when applicable.

b. Specialty Vehicles. Develop an AHA prior to use. The AHA must include: (18-6.b)

- (1) The safe operations.
- (2) Limits of operational work areas.
- (3) Required PPE.
- (4) Vehicle safety equipment requirements for each specialty vehicle.

c. Remote Operated Heavy Equipment and Machinery. Develop an AHA for the intended operations for all heavy equipment and machinery operated by remote control not otherwise specified elsewhere in this manual. The AHA must include: (18-6.c)

(1) A process for notifying affected personnel that a remote vehicle is operating in the work area.

- (2) Potential locations of utility interference.
- (3) Location and process for emergency shut off.
- (4) Potential radiation hazards for equipment or material being managed.
- (5) Personnel qualified to operate the equipment (see para 18-3).
- (6) Process for retrieving lost equipment.
- (7) Process for handling equipment that has lost control.

d. Floating Equipment. A QP must evaluate all equipment placed or operating on barges, pontoons, vessels, or other means of floatation for safe placement, transport, and operating conditions according to paragraph 18-8.j. The evaluation must be documented and included in the AHA for approval by the USACE supervisor or acceptance by the KO or COR prior to the commencement of work. (18-6.d)

e. Risk Assessments. Risk assessments according to paragraph 18-8.b when applicable. (18-6.e)

18-7. Minimum Plan Requirements.

Not Applicable.

18-8. General Requirements.

The requirements in this paragraph apply to the operation of motor vehicles, machinery and mechanized equipment, drilling equipment, ATVs, UTVs, and other specialty

vehicles. Operators of these items must also comply with state and host nation regulations as applicable to the above listed equipment.

a. Tests, Maintenance, and Repairs. (18-8.a)

(1) Tests, maintenance, and repairs must be conducted by a QP according to the manufacturer's instructions. All tests, maintenance, and repairs must be documented. (See para 18-5)

(a) For contract operations, keep records of maintenance and repairs conducted during the life of the contract available upon request of the KO or COR.

(b) For USACE operations, keep records of maintenance and repair for the duration of ownership.

(2) Whenever any motor vehicles, machinery and mechanized equipment, drilling equipment, ATVs, UTVs, or other specialty vehicles are found to be unsafe, or whenever a deficiency that affects the safe operation is observed, the equipment must immediately be taken out of service and its use prohibited until unsafe conditions have been corrected.

(a) Place a tag indicating the equipment must not be operated in a conspicuous location on the equipment. Where required, follow LOTO procedures. (See chapter 12).

(b) Tags must remain in place until removed by a QP after corrections are complete and the equipment has been retested and reinspected.

b. Guarding and Safety Devices. Do not remove guards, safety appliances, or devices from vehicles or machinery and mechanized equipment, or make them ineffective, except for when making immediate repairs, lubrications, or adjustments, and then only after the equipment has been de-energized and HECF LOTO procedures are implemented. Immediately replace all guards and devices upon completion of repairs and adjustments and before the item is released from LOTO. (See chapter 12) (18-8.b)

(1) Reverse Signal (back-up) Alarm. All self-propelled construction and industrial equipment, dump trucks, and cargo trucks, whose trailer or body permanently block the view to the rear, whether moving alone or in combination, must be equipped with a back-up alarm.

Note. Equipment designed and operated so that the operator is always facing the direction of motion does not require a back-up alarm.

Note. Commercial cargo vehicles such as pick-up trucks, utility cargo/tool trucks, and flat-bed cargo trucks intended for use on public highways with a normally clear view through the rear window are not required to have back-up alarms. If the rear view is

temporarily obstructed by a load or permanently blocked by a utility/toolbox or other modification, then a signal person may be used, if the value outweighs the risk to the signal person. In lieu of a signal person, a back-up alarm must be installed.

(a) Back-up alarms must be audible and sufficiently distinct to be heard above the surrounding noise level.

(b) Alarms must operate automatically upon commencement of backward motion. Alarms may be continuous or intermittent (not to exceed 3-second intervals) and must operate during the entire backward movement.

(c) Do not remove or disable any back-up alarms.

(2) Warning Devices. Provide a warning device where there is danger to persons from moving equipment, swinging loads, buckets, booms, or similar. A signal person may be used in lieu of a warning device if the value outweighs the risk to the signal person.

(3) Guarding. Guard all belts, gears, shafts, pulleys, sprockets, spindles, drums, flywheels, chains, or other reciprocating, rotating, or moving parts of equipment when exposed to contact by persons or when they otherwise create a hazard.

(a) Guard or insulate all hot surfaces of equipment, including exhaust pipes or other lines to prevent injury or fire.

(b) All points requiring lubrication during operation must have fittings so located or guarded to be accessible without hazardous exposure.

(4) Design, construct, and install platforms, foot walks, steps, handholds, guardrails, and toe boards on machinery and mechanized equipment to provide safe footing and access ways.

(5) Provide machinery and mechanized equipment with suitable working surfaces of platforms, guardrails, and hand grabs when attendants or other employees are required to ride for operating purposes outside the operator's cab or compartment. Platforms and steps must be of nonskid material.

(6) Provide substantial overhead protection for the operators of forklifts and similar material handling equipment (see para 18-8.i).

(7) Brake Systems. Equip all vehicles, except trailers having a gross weight of 5,000 lbs. (2,268 kg) or less, with service brakes and manually operated parking brakes.

(a) Service and parking brakes must be adequate to control the movement of, to stop, and to hold the vehicle under all conditions of service.

(b) The braking systems on every combination of vehicles must be in approximate synchronization on all wheels and develop the required braking effort on the rear-most wheels first. The brake system must be configured so that the brakes are applied from the prime mover driver's seat. Exceptions to this are vehicles in tow by an approved tow bar hitch according to applicable federal, state, or local requirements.

(8) Locate fuel tanks so that spills or overflows will not run onto engine, exhaust, or electrical equipment.

(9) Direct exhaust or discharges from equipment so that they do not endanger persons or obstruct the view of the operator.

(10) Use a safety tire rack, cage, or equivalent protection when inflating, mounting, or dismounting tires installed on split rims, or rims equipped with locking rings or similar devices.

(11) Seat Belts. All occupants of motor vehicles must wear seat belts. The seat belt assemblies and anchorages must comply with 49 CFR 571. Installation and use on buses is optional.

(a) Two-piece seat belts and anchorages for construction equipment must comply with applicable federal specifications or SAE J386.

(b) All construction equipment equipped with seat belts must have the seat belts worn by the operator, unless specified otherwise in the manufacturer's operating manual and justified in an AHA and approved in writing by the USACE supervisor or accepted by the KO or COR.

(12) All high-lift PITs must be equipped with overhead guards that meet the structural requirements defined in ANSI/ITSDF B56.1.

(13) Provide suitable protection against the elements, falling or flying objects, swinging loads, and similar hazards for operators of all machinery and mechanized equipment. Glass used in windshields or cabs must be safety glass.

(14) Falling Object Protective Structures (FOPS). Provide all bulldozers, tractors, or similar equipment used in clearing operations with guards, canopies, or grills to protect the operator from falling and flying objects as appropriate to the nature of the clearing operations.

(a) Furnish FOPS for other construction, industrial, and grounds-keeping equipment when the operator is exposed to falling object hazards.

(b) FOPS must be certified by the manufacturer or a licensed engineer.

(15) Rollover Protective Structures (ROPS).

(a) In addition to the requirements of paragraph 18-8.b, ROPS must be installed on:

(a-1) Crawler and rubber-tire tractors including dozers, push and pull tractors, winch tractors, and mowers.

(a-2) Off-the-highway self-propelled pneumatic-tire earth movers (for example, trucks, pans, scrapers, bottom dumps, and end dumps).

(a-3) Motor graders.

(a-4) Water tank trucks having a tank height less than the cab.

(a-5) Other self-propelled construction equipment such as front-end loaders, backhoes, rollers, and compactors.

(b) ROPS are not required on:

(b-1) Trucks designed for hauling on public highways.

(b-2) Crane-mounted dragline backhoes.

(b-3) Sections of rollers and compactors of the tandem, steel-wheeled, and self-propelled pneumatic-tired type that do not have an operator's station.

(b-4) Self-propelled, rubber-tired lawn and garden tractors and side-boom pipe laying tractors operated solely on flat terrain (maximum 10-degree slope; 20-degree slope permitted when off-loading from a truck) not exposed to rollover hazards.

(b-5) Cranes, draglines, or equipment on which the operator's cab and boom rotate as a unit.

(c) ROPS may be removed from certain types of equipment when the work cannot be performed with the ROPS in place and when ROPS removal is justified and delineated in an AHA and approved in writing by the USACE supervisor or accepted by the KO or COR.

(d) The operating authority must furnish proof from the manufacturer or certification from an RPE that the ROPS complies with applicable SAE Standards (that is, J167, J1042, J1194). ROPS are also considered acceptable if they meet the criteria of any state that has a Department of Labor-approved OSHA program or meets Water and Power Resources Service requirements.

(16) All machinery and mechanized equipment and material hoists operating on rails, tracks, or trolleys must have positive stops or limiting devices either on the equipment, rails, tracks, or trolleys to prevent overrunning safe limits.

(17) Under the following circumstances, long-bed end-dump trailers used in off-road hauling must be equipped with a rollover warning device. The device must have a continuous monitoring display at the operator station to give the operator a quick and easily read indicator and audible warning of an unsafe condition:

(a) The material being dumped is subject to being stuck or caught in the trailer rather than exiting the bed freely.

(b) The dumpsite cannot be maintained in a nominally level condition (that is, lateral slope less than 1°- 2°).

Note. If a rollover warning device is unavailable, a CP must perform a risk assessment and document the findings in the AHA as to why this requirement is not practical. Identify appropriate precautions and/or controls to ensure an equal level of safety is being accomplished.

(18) Vehicle Lighting. Equip vehicles or combinations of vehicles with the following equipment, except motorcycles and specialty vehicles, whenever visibility conditions warrant additional light:

(a) Two headlights, one on each side in the front.

(b) At least two red taillights, one on each side of the rear.

(c) Directional signal lights (both front and back).

(d) Three emergency flares or visible emergency warning lights or equivalent portable warning device.

c. Operating Rules. (18-8.c)

(1) Do not get off or on any motor vehicles, machinery and mechanized equipment, ATV's, UTV's and other specialty vehicles while they are in motion.

(2) Do not use cellular telephones when operating a government-owned motor vehicle. Hands-free devices only may be used.

(a) Prior to using a hand-held cellular phone, find a safe place to bring the vehicle to a stop.

(b) Text messaging by the operator is strictly prohibited while operating motor vehicles.

(3) Do not use any other portable headphones, earphones, or other listening devices (except for hands-free devices) while operating a government-owned motor vehicle.

(4) Do not eat, drink alcohol, or smoke while the vehicle is in motion.

(5) Global Positioning System (GPS).

(a) Mount the GPS so that it does not create sight hazards for the operator. A non-mounted GPS may only be used by the vehicle operator while the vehicle is in a stopped position.

(b) Do not program the GPS while the vehicle is in motion.

(6) Never exceed speeds greater than the posted speed limit. Reduce speeds when road conditions reduce the ability to maintain control of the vehicle or stop within a safe distance.

(7) Headlights must be on during fog, smoke, rain, from sunset to sunrise, and at any other time when there is not sufficient light for the vehicle to be seen or the operator to see on the highway at a distance of 500 feet (152.4 m), unless local regulations prohibit.

(8) Do not drive motor vehicles on a downgrade with gears in neutral or clutch disengaged.

(9) Railroad Crossings and Drawbridges.

(a) Upon approaching a railroad crossing or drawbridge, slow vehicle speeds to permit stopping before reaching the nearest track or the edge of the draw bridge and proceed only if the course is clear.

(b) Vehicles transporting 15 or more persons, explosives, or flammable or toxic substances must stop at railroad crossings and drawbridges and must not proceed until the course is clear, except at a railroad crossing or drawbridge protected by a traffic officer or a traffic signal giving a positive indication for approaching vehicles to proceed.

(10) Do not stop, park, or leave standing vehicles on any road in a position that would endanger the occupants, the vehicle, personnel in the area, or other vehicles. Ascertain a safe exit path before exiting vehicle.

(11) Do not leave vehicles unattended until the motor has been shut off, the key removed (unless local regulations prohibit), parking brake set (when applicable), and gear engaged in low, reverse, or park.

(12) Do not get between a towed vehicle and towing vehicle except when hooking or unhooking.

(13) Do not move vehicles or combination of vehicles hauling unusually heavy loads or equipment until the driver has been provided with the required permits, the correct weights of the vehicles and load, and a designated route to be followed according to this manual, applicable federal, state, or local requirements.

(14) When maneuvering or performing back-up operations, use a signal person when the point of operation (that is, area of load travel and area immediately surrounding the load placement) is not in full view of the operator, when vehicles are backed more than 100 feet (30.5 m), when terrain is hazardous, or when two or more vehicles are backing up in the same area. If a signal person or spotter is not used, operators must walk behind their vehicle to view the area for possible hazards before performing back-up operations with their vehicle. (See chapter 8)

(15) When vehicles or machinery and mechanized equipment are parked or disabled on a highway or the adjacent shoulder, use yellow flashing lights and other traffic warning devices (for example, cones, flags, signs) during the daytime and reflectors, flares, electric lights, or other effective means of identification at night.

(16) Loading Vehicles.

(a) Leave the cab while the vehicle is being loaded when exposed to danger from suspended loads or overhead loading equipment unless the cab is adequately protected.

(b) Do not load vehicles in a manner that obscures the driver's view ahead or to either side, or which interferes with the safe operation of the vehicle.

(c) Distribute, chock, tie down, and secure all loads. Cover the load when there is a hazard of flying or falling dirt, rock, debris, or other materials. Do not remove tail gates without first implementing a positive means to prevent the material from falling out of the back of the vehicle, and only as approved by the USACE supervisor or accepted by the KO or COR.

(d) When carrying loads that project beyond the front, sides or rear of the vehicle or trailers, attach a red flag, not less than 144 in² (929 cm²), at or near the end of the projection. At night or when atmospheric conditions restrict visibility, use a warning light in lieu of the red flag. Ensure the load does not obscure vehicle lights and/or reflectors.

(17) Maintenance Vehicles. Equip all maintenance vehicles that are used at USACE recreational areas (or projects) with two 28 inches (71 cm) day glow/high-visibility orange traffic cones. When parked, place a cone in front and behind the vehicle, and remove and place in vehicle prior to departure.

d. Transportation of Personnel. (18-8.d)

(1) Do not exceed the number of passengers in passenger-type vehicles than the number that can be seated.

(2) Trucks used to transport personnel must be equipped with a securely anchored seating arrangement, a rear end gate, and guardrail. Provide steps or ladders for mounting and dismounting.

(3) Guard, stow, and secure all tools and equipment when transported with personnel.

(4) Do not ride with arms or legs outside of a vehicle body, in a standing position on the body, on running boards, or seated on side fenders, cabs, cab shields, bed of the truck, or on the load.

(5) Protect passengers from inclement weather elements. Enclose all vehicles transporting personnel during cold or inclement weather.

(6) Do not transport explosives, flammable materials (excepting normal fuel supply), or toxic substances within or on vehicles carrying personnel.

(7) Do not move vehicles transporting personnel until the driver has confirmed all persons are seated, and the guardrails and rear end gates are in place or doors are closed.

e. Motor Vehicles (for Public Roadway Use). (18-8.e)

(1) All motor vehicles for use on public roadways must be equipped with the following:

(a) An operable speedometer.

(b) An operable fuel gauge.

(c) An operable audible warning device (for example, horn).

(d) An adequate rearview mirror or mirrors.

(e) A power-operated starting device.

(f) A windshield equipped with an adequate windshield wiper.

(g) An operable defrosting and defogging device.

(h) Non-slip surfaces on steps.

(i) Cabs, cab shields, and other protection to protect the driver from the elements and falling or shifting materials.

Note. Motorcycles. Items (f) through (i) do not apply to motorcycles.

(2) Motor Vehicle Operators. Operators of motor vehicles, while on duty, must not operate vehicles for a continuous period of more than ten 10-hours in any 24-hour period; moreover, no employee, while on duty, may operate a motor vehicle after being in a duty status for more than 12-hours during any 24-hour period. A minimum of 8 consecutive hours of rest between shifts in a 24-hour period is required.

(3) Shut down all motor vehicles prior to and during fueling operations.

(4) Operators and passengers of motorcycles must always wear gloves, a DOT-approved motorcycle helmet with full face shield, visor or goggles, sturdy footwear, long sleeved shirt or jacket, long trousers, full fingered gloves, and high-visibility garments (bright color for day and retroreflective for night).

(5) Glass in windshields, windows, and doors must be safety glass. Replace any cracked or broken glass.

(6) Equip all buses, trucks, and combinations of vehicles with a carrying capacity of 1.5 tons (1,360.8 kg) or over that are operated on public highways with emergency equipment required by state laws, but not less than the following:

(a) One red flag not less than 144 in² (929 cm²) and three reflective markers available for immediate use in case of emergency stops.

(b) Two-wheel chocks for each vehicle or each unit of a combination of vehicles.

(c) At least one 2A:10B:C fire extinguisher (see chapter 9).

(7) Equip all rubber-tired motor vehicles with fenders. Tires must not extend beyond fenders. Mud flaps may be used in lieu of fenders whenever motor vehicle equipment is not designed for fenders.

f. Trailers. (18-8.f)

(1) All towing devices used on any combinations of vehicles must be structurally adequate for the weight drawn and properly mounted.

(2) Provide a locking device or double safety system on every fifth-wheel mechanism and tow bar arrangement to prevent accidental separation.

(3) Couple trailers to the towing vehicle with safety chains or cables. The chains or cables must prevent the separation of the vehicles in case of tow bar failure.

(4) Provide a breakaway device for trailers equipped with power brakes. The breakaway device must effectively lock the brakes in the event the trailer separates from the towing vehicle.

g. Machinery and Mechanized Equipment. (18-8.g)

(1) Do not make modifications or additions that affect the capacity or safe operation of machinery or equipment without the manufacturer's written approval.

(a) If such modifications or changes are made, the capacity, operation, and maintenance instruction plates, tags, or decals must be changed accordingly.

(b) In no case may the original safety factor of the equipment be reduced.

(2) Do not operate machinery or equipment in a manner that will endanger persons or property.

(a) Do not exceed the safe operating speeds or loads.

(b) Operate machinery and equipment according to the manufacturer's instructions and recommendations.

(c) Headphones may only be worn for communication directly related to operating the machine or mechanized equipment. Do not use headphones for entertainment purposes (for example, radio, CD, music, books) while operating equipment.

(d) Do not use cell phones or any other electronic device that may cause distractions while operating equipment.

(3) If the manufacturer's instructions or recommendations are more stringent than the requirements of this manual, follow the more stringent requirements.

(4) All machinery and mechanized equipment must be equipped with the following:

(a) An operable fuel gauge.

(b) An operable audible warning device (for example, horn).

(c) Adequate rearview mirror or mirrors.

(d) Non-slip surfaces on steps.

(e) A power-operated starting device.

(f) A seat or equal protection for each person required to ride on equipment (unless standing is permitted by the equipment manufacturer).

(g) Powered wipers for all equipment with windshields. Equip vehicles that operate under conditions that cause fogging or frosting of windshields with operable defogging or defrosting devices.

(h) Glass in windshields, windows, and doors must be safety glass. Replace cracked or broken glass.

(5) Mobile equipment must have a service brake system and a parking brake system capable of stopping and holding the equipment while fully loaded on the grade of operation.

(6) Equipment Operators. Operators of machinery and mechanized equipment, will not be permitted to exceed 12-hours of duty time in any 24-hour period, including time worked at another occupation. A minimum of 8 consecutive hours of rest between shifts in a 24-hour period is required.

(7) Shut down mechanized equipment before and during fueling operations. Closed systems, with an automatic shut-off that will prevent spillage if connections are broken, may be used to fuel diesel powered equipment left running.

(8) Fully lower or block bulldozer and scraper blades, end-loader buckets, dump bodies, and similar equipment when being repaired or when not in use. All controls must be in a neutral position with the engines stopped and brakes set unless work being performed on the machine requires otherwise.

(9) Place stationary machinery and equipment on a firm foundation and secure it before operating.

(10) Adequately illuminate all mobile equipment and the areas in which they are operated while work is in progress (see chapter 7).

(11) Do not operate equipment powered by an internal combustion engine in or near an enclosed area unless adequate ventilation is provided to ensure the equipment does not generate a hazardous atmosphere.

(12) Display yellow flashing lights or four-way flashers visible from all directions on machinery or mechanized equipment parked on or moving slower than normal traffic on haul roads.

(13) Provide all machinery or equipment operating on rails, tracks, or trolleys (except railroad equipment) with substantial track scrapers or track clearers (effective in both directions) on each wheel or set of wheels.

(14) Do not use steering or spinner knobs unless originally designed or approved in writing by the manufacturer.

(15) Provide safeguards (for example, bumpers, railings, tracks,) to prevent machinery and equipment operating on a floating plant from going into the water (see chapter 19).

(16) Do not operate the controls of loaders, excavators, or similar equipment with folding booms or lift arms from a ground position unless so designed.

(17) Do not work in, pass under, or ride in the buckets or booms of loaders in operation.

(18) Operate tire service vehicles so that the operator will be clear of tires and rims when hoisting operations are being performed. Secure tires large enough to require hoisting equipment from movement by continued support of the hoisting equipment unless bolted to the vehicle hub or otherwise restrained.

(19) Equip each bulldozer, scraper, dragline, crane, motor grader, front-end loader, mechanical shovel, backhoe, and other similar equipment with at least one dry chemical or CO₂ fire extinguisher with a minimum rating of 10-B:C (see chapter 9).

(20) Secure fill hatches on water haul vehicles or reduce their opening to a maximum of 8 inches (20.3 cm).

(21) Maintenance and Repairs.

(a) Shut down and take positive means to prevent the operation of all machinery or equipment while repairs or manual lubrications are performed. Equipment designed to be serviced while running are exempt from this requirement.

(b) Make all repairs on machinery or equipment at a location that will protect repair personnel from traffic.

(c) Substantially block or crib heavy machinery, equipment, or parts thereof that are suspended or held apart by slings, hoist, or jacks before personnel work underneath or between them.

(22) Parking.

(a) Set the parking brake whenever equipment is parked.

(b) When equipment is parked on an incline, have the wheels chocked or track mechanisms blocked and the parking brake set.

(c) When equipment is left unattended at night adjacent to a highway in normal use or adjacent to construction areas where work is in progress, provide lights or reflectors or barricades equipped with lights or reflectors to identify the location of the equipment.

(23) Towing.

(a) All towing devices used on any combination of equipment must be structurally adequate for the weight drawn and securely mounted.

(b) Do not get between a towing vehicle and the piece of towed equipment until both have been completely stopped, the brakes are set, and wheels chocked on both the vehicle and equipment.

h. Dump Trucks. (18-8.h)

(1) Equip all dump trucks with a physical holding device to prevent accidental lowering of the body while maintenance or inspection work is being done.

(2) Secure all hoist levers to prevent accidental starting or tripping of the mechanism.

(3) Equip all off-highway end-dump trucks with a means to determine whether the dump box is lowered. The means must be plainly visible from the operator's position while looking ahead.

(4) Arrange trip handles for dump truck tailgates to keep the operator clear of interference.

i. Powered Industrial Trucks (PITs), Forklifts, and Telehandlers. All PITs, forklifts and telehandlers must meet the requirements of design, construction, stability, inspection, testing, maintenance, and operation according to ANSI/ITSDF B56.1. (18-8.i)

(1) When PITs, forklifts, or telehandlers are configured to hoist and lower (by means of a winch or hook and/or with rigging) and horizontally move a suspended load, refer to chapters 15 and 16.

(2) All PITs, lift trucks, stackers, and similar equipment must have the rated capacity posted on the vehicle clearly visible to the operator. When the manufacturer provides auxiliary removable counterweights, the corresponding alternate rated capacities must be clearly shown on the vehicle. Do not exceed the ratings.

(3) All PIT operators must be trained, qualified, and designated according to paragraph 18-3.

(4) When a PIT is left unattended, fully lower the load engaging means, neutralize the controls, shut off power, and set the brakes. Chock the wheels if the truck is parked on an incline.

(5) Utilize an overhead guard as protection against falling objects. It should be noted that an overhead guard is intended to offer protection from the impact of small material but not to withstand the impact of a falling capacity load.

(6) Properly secure dock board and bridge plates before they are driven over. Carefully and slowly drive over the dock board or bridge plates and never exceed their rated capacities.

(7) Operate the PIT at a speed that will permit it to be brought to a stop in a safe manner.

(8) On all grades, appropriately tilt back the load and load engaging means and raise the load only as far as necessary to clear the road surface.

(9) When ascending or descending grades in excess of 10%, drive loaded PITs with the load upgrade.

j. Floating Equipment. A QP must evaluate all equipment placed or operating on barges, pontoons, vessels, or other means of flotation for safe placement, transport, and operating conditions. At a minimum, the evaluation must include: (18-8.j)

(1) Proper operating procedures according to the manufacturer's instructions.

(2) Stability and structural assessment of equipment and barge/pontoon.

(3) Where and how the equipment will be secured to address positively secured positioning of the equipment (no movement/tipping), if required.

(4) Environmental restrictions.

(5) If the QP determines that the equipment can safely operate under the anticipated conditions within the manufacturer's operating procedures, the evaluation must be documented in writing by the QP and included in the AHA and provided to the USACE supervisor/KO or COR prior to work beginning (see para 18-6).

(6) Use of this equipment in this capacity is not allowed if the equipment cannot safely operate under the anticipated conditions and within the manufacturer's operating procedures, or if the QP determines that it is not safe to do so.

(7) If there are no manufacturer's operating procedures, an RPE with knowledge and experience with this type of equipment, must develop the safe operating procedures. The QP may then perform the evaluation of the equipment and

barge/pontoon. Document the evaluation in the AHA and provide a copy to the USACE supervisor/KO or COR prior to starting work. (See para 18-6)

(8) If this equipment is mechanized equipment used in conjunction with rigging to lift a load, it is considered LHE (see chapter 16).

k. Drilling Equipment. (18-8.k)

(1) Keep a copy of the drill manual available at the jobsite.

(2) Equip drilling equipment with two easily accessible emergency shutdown devices, one for the operator and one for the helper, unless it is designed by the manufacturer to have a single operator and single kill switch.

(a) Shut down rigs before any personnel enter the operational area of the drill.

(b) Position auger heads in the hole or place a cover over the hole before workers enter the operational area of the drill.

(c) If infeasible due to type of equipment being used, a CP must perform a risk assessment and document the findings in the AHA as to why this requirement is not practical. Identify appropriate precautions and/or controls to ensure an equal level of safety is being accomplished. (See para 18-6)

(3) Maintain clearance from electrical sources according to table 11-4.

(a) Post signs on the drilling equipment warning the operator of electrical hazards.

(b) Ensure proper clearance before moving equipment. Clearance must be monitored by a spotter. An electrical proximity warning device may be used in addition to a spotter to aid in the detection of live lines.

(4) Moving Equipment.

(a) Before drilling equipment is moved, survey the travel route for overhead and terrain hazards, particularly overhead electrical hazards.

(b) Do not transport earth drilling equipment with the mast up. The equipment may be moved with the mast up to drill a series of holes, such as in blasting, if the following conditions are satisfied:

(b-1) Movement is over level, smooth terrain.

(b-2) The path of travel has been inspected for stability and the absence of holes, other ground hazards, and electrical hazards.

(b-3) Travel is performed according to the manufacturer's instructions.

(5) Equipment Set-up.

(a) Set-up equipment on stable ground and maintain it level. Use cribbing when necessary.

(b) Extend outriggers according to the manufacturer's instructions.

(c) Follow the requirements of chapter 34 when drilling equipment is operated in areas with the potential for classification as a confined space.

(6) Equipment Operation.

(a) Monitor the weather conditions. Cease operations during electrical storms or when electrical storms are imminent. (See paras 1-7 or 2-7, as applicable)

(b) Drill crewmembers must not wear loose clothing, jewelry, or equipment that might become caught in moving machinery. High visibility vests used on drilling rigs, if required, must be of the break-away type.

(c) Utilize auger guides on hard surfaces. If infeasible due to type of drill rig being used, a CP must prepare a risk assessment and document the findings in the AHA as to why this requirement is not feasible. Identify appropriate precautions and/or controls to ensure an equal level of safety is being accomplished. (See para 18-6)

(d) Verbally alert employees and visually ensure employees are clear from dangerous parts of equipment before starting or engaging equipment.

(e) Direct the discharge of drilling fluids away from the work area to prevent the pooling of water.

(f) Utilize hoists only for their designed intent and do not load them beyond their rated capacity. Take steps to prevent two-blocking of hoists.

(g) Follow the equipment manufacturer's instructions if rope becomes caught in, or objects get pulled into, a cathead.

(h) Do not run or rotate drill rods through rod slipping devices. Do not hoist more than 1 foot (0.3 m) of drill rod column above the top of the drill mast. Do not make up, tighten, or loosen drill rod tool joints while the rod column is supported by a rod-slipping device.

(i) Control dust. Implement the requirements contained in chapter 6 when there is potential for silica exposure.

(j) Clean augers only when the rotating mechanism is in neutral and the auger is stopped. Use long-handled shovels to move cutting from the auger.

(k) Cap and flag open boreholes. Barricade open excavations.

(l) Provide means to guard against employee contact with the auger (for example, guard around the auger; barricade around the perimeter of the auger; electronic brake activated by a presence-sensing device). Employees must maintain a safe, clear distance while the drilling equipment is operating. If infeasible due to the type of drill equipment being used, the employee may proceed to approach the drill only when the drill has stopped rotating, the controls returned to the neutral position, and a clear signal has been given by the operator and understood by the helper that it is safe.

(m) Do not use side-feed swivel collars on drill rods unless they are retained by either a manufacturer-designed stabilizer or a stabilizer approved by an RPE.

I. All-Terrain Vehicles (ATVs). (18-8.1)

(1) All ATVs must be equipped with the following:

(a) An adequate audible warning device (for example, horn) at the operator's station in operable condition (if determined necessary for the work being performed).

(b) Brake lights in operable condition (regardless of light conditions).

(c) Operable rear-view mirror (mirrors may be present on handlebars).

(d) Mufflers.

(e) Spark arresters.

(2) Do not exceed the manufacturer's recommended payload and passenger limitations at any time.

(3) All operators and passengers must wear gloves and a DOT-approved motorcycle helmet with full-face shield or goggles at all times while operating ATVs.

(4) Do not drive ATVs on public roadways except to cross the roadway at designated crossing points or with a road guard. Paved road use may occur only explicitly when allowed by the manufacturer and when permitted by local laws and regulations.

(5) Use only ATVs with four or more wheels.

(6) Keep a copy of the operator's manual on the vehicle and protect it from the elements, if practical.

(7) Inflate tires according to the manufacturer's instructions.

m. Utility Terrain Vehicles (UTVs). (18-8.m)

(1) Maintain a copy of the operator's manual on the vehicle at all times and protect it from the elements.

(2) All UTVs must be equipped with the following:

(a) An adequate audible warning device (for example, horn) located at the operator's station.

(b) Brake lights in operable condition regardless of light conditions.

(c) Operable rear-view mirror.

(3) Do not exceed the manufacturer's designated occupancy (that is, designated seating that has built-in seat belts). Do not ride in the vehicle's back cargo area unless the vehicle is otherwise equipped to seat passengers with seat belts.

(4) Do not exceed the manufacturer's recommended load carrying capacity, personnel capacity, or maximum safe vehicle speed at any time.

(5) Secure cargo items as necessary to prevent movement or tipping. All loads over 50 lbs. (22.7 kg), to include medical litters, must be securely strapped to cargo tie-downs.

(6) Maintain manufacturer-installed safety equipment in working order and use according to the manufacturer's instructions.

(7) When a UTV is not equipped with a windshield, the operators and passengers must wear a DOT-approved motorcycle helmet with full-face shield or goggles when in motion.

(8) Do not drive UTVs on public roadways except to cross the roadway at designated crossing points or with a road guard.

(9) UTVs that are allowed to operate outside a controlled work area and/or on public roads must meet the minimum vehicle safety standards, to include ROPS, seat belts, and placement of "Slow Moving Vehicle" emblems where required.

(10) When not equipped with ROPS, operators and passengers of UTVs must wear approved head protection (helmet) and protective goggles or face shield.

n. Specialty Vehicles. (18-8.n)

(1) Whenever visibility conditions warrant additional light, equip all vehicles or combinations of vehicles with at least one headlight and one taillight in operable condition.

(2) Do not exceed the manufacturer's recommended load carrying capacity, personnel capacity, or maximum safe vehicle speed at any time.

(3) Utilize specialty vehicles only for their intended purpose. Maintain manufacturer-installed safety equipment in working order and use according to the manufacturer's instructions.

(4) Secure cargo items as necessary to prevent movement or tipping.

(5) Do not operate specialty vehicles on unimproved surfaces unless designed to do so.

(6) Wear head protection when operating Segway human transporters. At minimum, an approved bicycle helmet must be worn.

(7) Snow Machines.

(a) Use snow machines on public roadways only where authorized by state and local regulations or in an emergency.

(b) All snow machines must be equipped with the following:

(b-1) Brakes that will work under normal driving conditions and when loading.

(b-2) A throttle in which, when released by hand, will return engine speed to idle, close the carburetor, and disengage the clutch.

(b-3) A rear snow flap to deflect material or objects thrown by the track.

(b-4) A protective shield over all moving parts.

(b-5) Reflectors on the sides or side cowling.

(b-6) A rigid drawbar that is no longer than 10 feet (3 m) when towing.

(b-7) Operable rear-view mirror.

(c) Passengers are not authorized on single person snow machines except in case of an emergency.

(d) Conduct snow machine operations with at least a team of two snow machines.

(e) When working more than five miles from a support base and using snow machines, use a supporting track vehicle.

18-9. Figures and Tables.

Not Applicable.

18-10. Checklists and Forms.

a. DA Form 348, Equipment Operator's Qualification Record (Except Aircraft) (https://armypubs.army.mil/ProductMaps/PubForm/DAForm1_1000.aspx) (18-10.a)

b. OF 346, U.S. Government Motor Vehicle Operator's Identification Card (<https://www.gsa.gov/reference/forms/us-government-motor-vehicle-operators-identification-card>) (18-10.b)

Chapter 19

Floating Plant and Marine Activities

19-1. References.

a. ABS Classification Certificate (<https://ww2.eagle.org/en/rules-and-resources/rules-and-guides.html>) (19-1.a)

b. American Boat and Yacht Council (ABYC) Standards (<https://abycinc.org/page/standards>) (19-1.b)

c. ASTM F1166, Standard Practice for Human Engineering Design for Marine Systems, Equipment, and Facilities (<https://www.astm.org/products-services/standards-and-publications.html>) (19-1.c)

d. EP 1130-2-500, Partners and Support (Work Management Guidance and Procedures), Appendix L- Agreement Between USACE and U.S. Coast Guard (<https://www.publications.usace.army.mil/USACE-Publications/Engineer-Pamphlets/>) (19-1.d)

e. ER 385-1-91, Training, Testing, and Licensing for Operators of Class A and Class I Motorboats (<https://www.publications.usace.army.mil/USACE-Publications/Engineer-Regulations/>) (19-1.e)

f. ISO 15085, Small Craft - Man-Overboard Prevention and Recovery (<https://www.iso.org/standards.html>) (19-1.f)

- g. National Association of Safe Boating Law Administrators (NASBLA), NASBLA Approved Education Courses (<https://www.nasbla.org/education/approved-boating-courses>) (19-1.g)
- h. NAVMED P-5010-6, Manual of Provocative Medicine, Water Quality Afloat (<https://www.med.navy.mil/Directives/All-Pubs-and-Manuals/>) (19-1.h)
- i. NFPA 70, National Electrical Code (NEC) (<https://www.nfpa.org/Codes-and-Standards>) (19-1.i)
- j. NFPA 302, Fire Protection Standard for Pleasure and Commercial Motor Craft (<https://www.nfpa.org/Codes-and-Standards>) (19-1.j)
- k. Title 33, United States Code (USC) Subchapter I (33 USC Subchapter I) - Oil Pollution Liability and Compensation (<https://www.govinfo.gov/content/pkg/USCODE-2020-title33/pdf/USCODE-2020-title33-chap40-subchapl.pdf>) (19-1.k)
- l. USCG Form CG-835F, Facility Inspection Requirements (<https://www.dcms.uscg.mil/forms>) (19-1.l)
- m. 33 CFR, Navigation and Navigable Waters (<https://www.govinfo.gov/content/pkg/CFR-2012-title33-vol1/pdf/CFR-2012-title33-vol1-chapl.pdf>) (19-1.m)
- n. 33 CFR 155, Oil or Hazardous Material Pollution Prevention Regulations for Vessels (<https://www.govinfo.gov/content/pkg/CFR-2021-title33-vol2/pdf/CFR-2021-title33-vol2-part155.pdf>) (19-1.n)
- o. 33 CFR Part 156, Oil and Hazardous Material Transfer Operations (<https://www.govinfo.gov/content/pkg/CFR-2021-title33-vol2/pdf/CFR-2021-title33-vol2-part156.pdf>) (19-1.o)
- p. 40 CFR 141, National Primary Drinking Water Regulation (<https://www.govinfo.gov/content/pkg/CFR-2015-title40-vol23/pdf/CFR-2015-title40-vol23-part141.pdf>) (19-1.p)
- q. 46 CFR Shipping Subpart B – Special Rules Pertaining to Deck Cargo Barges (<https://www.govinfo.gov/content/pkg/CFR-2016-title46-vol1/pdf/CFR-2016-title46-vol1.pdf>) (19-1.q)
- r. 46 CFR 25.30-15, Fixed Fire Extinguishing Systems (<https://www.govinfo.gov/content/pkg/CFR-2022-title46-vol1/pdf/CFR-2022-title46-vol1-sec25-30-15.pdf>) (19-1.r)
- s. 46 CFR 58.50, Rudder Stops (<https://www.govinfo.gov/content/pkg/CFR-2022-title46-vol2/pdf/CFR-2022-title46-vol2-sec58-25-50.pdf>) (19-1.s)

t. 46 CFR 98.30, Portable Tanks and Intermediate Bulk Containers (<https://www.govinfo.gov/content/pkg/CFR-2022-title46-vol4/pdf/CFR-2022-title46-vol4-part98-subpart98-30.pdf>) (19-1.t)

u. 49 CFR 171, Hazardous Material Regulations, General Information, Regulations, and Definitions (<https://www.govinfo.gov/content/pkg/CFR-2020-title49-vol2/pdf/CFR-2020-title49-vol2-part171.pdf>) (19-1.u)

19-2. Definitions.

a. Crane, Floating. A rotating superstructure, power plant, operating machinery, and boom mounted on a barge or pontoon. The power plant may be installed below decks. The crane's function is to handle loads at various radii. (19-2.a)

b. Dredge. Any vessel fitted with machinery for the purpose of removing or relocating material from or in a body of water. (19-2.b)

c. Duck Pond. Openings between stationary vessels or vessels and other structures that create fully enclosed water areas (duck ponds) into which personnel could fall. (19-2.c)

d. Emergency (Marine). An unforeseen development that imposes an immediate hazard to the safety of the vessel, the passengers, the crew, the cargo, property, or the marine environment requiring urgent action to remove or mitigate the hazard. (19-2.d)

e. Floating Plant/Vessel. Used to transport personnel, work boats, floating cranes and derricks, barges, patrol boats, etc. (19-2.e)

f. Gangway. Any ramp, stairway, or ladder provided for personnel to board/leave a vessel. (19-2.f)

g. Manned Vessels. Vessels that operate with crews, quartered personnel, or that have work areas that are occupied by assigned personnel during normal work activities. (19-2.g)

h. Marine Activities. Operations and work involving proximity to or on water. (19-2.h)

i. Red Flag Barge/Vessel. A barge/vessel carrying in bulk hazardous cargoes regulated by Subchapter D (petroleum) and O (chemical) of 46 CFR Chapter I, or vessels whose primary purpose is the transporting of flammable or other hazardous cargoes (for example, oil tankers, chemical parcel tankers, liquid chemical barges, liquefied gas tankers). (19-2.i)

j. Station Bill. A placard that designates vessel personnel duties and procedures to be followed in the event of an emergency or emergency drill. Placards must be

permanently placed in personnel quarters and work areas and are strategically located throughout the vessel. (19-2.j)

k. Unmanned Vessels. Vessels that carry cargo such as materials, supplies, equipment, or liquids, and do not have personnel on board during normal operations. (19-2.k)

l. Vessel. Every type of watercraft or artificial contrivance used, or capable of being used, as a means of transportation on water, including special-purpose floating structures not primarily designed for or used as a means of transportation on water. (19-2.l)

19-3. Personnel Required Qualification/Training.

a. Officers and crew must possess a current, valid USCG credential and/or correctly endorsed document according to 46 CFR 15.401 that must be posted in a public area on board the vessel. (19-3.a)

Note. Generally, vessels 100 gross tons and greater require credentialed officers and crew.

b. Motorboat Operators (vessels less than 26 feet (7.9 m) in length). All motorboat operators must complete and document the following training: (19-3.b)

(1) A boating safety course meeting the criteria of the USCG Auxiliary, NASBLA, or equivalent.

(2) Motorboat handling training based on the type of boats to be operated and taught by qualified instructors. Operators must pass a written and operational test.

(3) Current USCG licensed personnel are exempt from the boating safety course, but they must complete the written exam and operational test.

(4) Train USACE employees according to ER 385-1-91.

c. In addition to paragraphs 19-3.a and b, officers and crew of government floating plant must be licensed or credentialed by the USCG when the plant is subject to any of the following criteria: (19-3.c)

(1) The vessel is inspected and certified by USCG according to EP 1130-2-500, Appendix L.

(2) The vessel is normally engaged in or near a channel or fairway in operations that restrict or affect navigation of other vessels and is required by law to be equipped with radio-telephones of the 156-162 band frequency.

(3) The floating plant is engaged in the transfer of oil or hazardous material in bulk.

d. Operators of uninspected towing vessels, Masters, and Pilots on radar-equipped vessels 26 feet (7.9 m) and greater in length must possess a USCG Radar Observers endorsement issued by a USCG-approved training facility. (19-3.d)

e. Inspectors. All inspectors must have at least five years of experience in commercial marine plant and equipment and be accredited by the National Association of Marine Surveyors or the Society of Accredited Marine Surveyors (see para 19-5.a). (19-3.e)

19-4. Roles and Responsibilities.

a. Competent Persons (CP). Identify and control for duck ponds (see para 19-8.e). (19-4.a)

b. Vessel Operators. (19-4.b)

(1) Prepare float plans (see para 19-7-c).

(2) While operating in waters included in a small craft advisory, the sole duty of the operator is to operate the vessel.

c. Qualified Person (QP). (19-4.c)

(1) In the following circumstances, assign a QP to assist with deck duties of motorized vessels less than 26 feet (7.9 m) in length:

(a) When extended trips, including overnight trips, are made from the work site.

(b) When conditions of navigation make it hazardous for an operator to leave the wheel while underway.

(c) When operations, other than tying-in, require the handling of lines.

(d) When operating at night or during inclement weather.

(e) When towing.

(f) While a vessel is transporting crew or passengers.

(2) Perform inspections according to paragraph 19-5.

(3) Mobilize, demobilize, and relocate dredges, support barges, support tenders, tugs, and heavy equipment (see para 19-8.m).

d. Inspectors. Inspectors of other dredges, self-propelled vessels over 65 feet (19.8 m), crane barges, floating cranes, and floating plant with overnight/berthing accommodations not subject to USCG inspection and certification. Perform inspections according to paragraph 19-5. (19-4.d)

19-5. Inspection Requirements.

a. Floating Plant Inspection and Certification. (19-5.a)

(1) Ensure all USCG documentation is current for floating plants holding a USCG-issued Certificate of Inspection (COI) according to 46 CFR Part 91 before placing it in service. Post a copy of documentation in a public area on board the vessel. Make available to the USACE supervisor/KO or COR a copy of any USCG Form CG-835F (Facility Inspection Requirements) issued to the vessel in the preceding year and keep a copy on board the vessel.

(2) All dredges subject to load line regulations must obtain and maintain a valid load line. If applicable, maintain a valid USCG-issued COI according to 46 CFR Part 91 or ABS Classification Certificate. Ensure all USCG/ABS documentation is current before placing the vessel in service. Post a copy of the documentation in a public area on board the vessel. If applicable, make available to the USACE supervisor/KO or COR a copy of any USCG Form CG-835F issued to the vessel in the preceding year and keep a copy on board the vessel.

(3) Inspect annually in the working mode all other dredges, self-propelled vessels over 65-feet (19.8 m), crane barges, floating cranes, and floating plant with overnight/berthing accommodations not subject to USCG inspection and certification or not having a current ABS classification. A USCG Marine Inspector, an ABS surveyor, or a marine surveyor must perform all inspections. (See para 29-4.e)

(4) Inspect all other floating plant, motorized and non-motorized, before being placed in use and at least annually. Inspections must be completed by a QP.

(5) For all floating plants under paragraphs 19-5.a(3) and 19-5.a(4):

(a) Document the inspection using a hard copy or electronic checklist that is appropriate for the vessel being inspected that includes all 46 CFR and other applicable regulatory and safety requirements. Post a copy of the most recent inspection report in a public area on board the vessel, or, for smaller vessels, file and make available to the local SOHO/USACE supervisor/KO or COR upon request.

(b) The inspection must be appropriate for the intended use of the plant. At a minimum, include an evaluation of the structural condition, critical machinery components, watertight integrity (for example, bulkheads, seals), and lifesaving and safety devices and equipment according to NFPA 302.

(c) Conduct periodic inspections and tests to evaluate if a safe operating condition for all floating plants is being maintained.

(6) Remove from service all floating plants found in an unsafe condition and do not operate until all deficiencies have been corrected.

b. USACE Motorized Vessels (that is, less than 26 feet (19.8 m) in length) and Boat Trailers. Inspect, test, maintain, and repair vessels and boat trailers according to ER 385-1-91 and the manufacturer's instructions. (19-5.b)

(1) Inspections must be conducted and by a QP. Retain inspection records for a period of five years.

(2) Inspect all launches, motorboats, skiffs, boat trailers, and tow vehicles prior to each use and periodically using ENG Form 6175 (Small Boat (Less Than 26 Feet) and Equipment Checklist) (see para 19-10) and the manufacturer's recommendations.

c. Emergency Systems. Operate and inspect emergency lighting and power systems at least monthly to ensure proper operation (see para 19-8.b). (19-5.c)

d. Anchor Points. Inspect all anchor points prior to applying a load or putting cables under tension. (19-5.d)

e. Dredging. Conduct routine inspections of all submerged pipe to ensure anchorage (see para 19-8.m). (19-5.e)

f. Conduct documented inspections of life rings, ring buoys, and throw bags prior to placing in service and at least every six months. (19-5.f)

g. All motorboat operators must inspect and use the vessel engine cutoff device (kill switch) and safety lanyard and attach the safety lanyard to their person (exclusive use of wireless kill-switch devices are not authorized). (19-5.g)

19-6. Activity Hazard Analysis (AHA) Requirements.

Develop AHAs according to paragraphs 1-6 or 2-6, as applicable.

a. Identify locations and controls for operations where deck-edge perimeter protection is not present (see para 19-8.j). (19-6.a)

b. Include the locations and restricted activities for safe zones adjacent to Red Flag ships (see para 19-8.o). (19-6.b)

19-7. Minimum Plan Requirements.

Prior to beginning work, submit the below plans to the USACE supervisor for approval or acceptance by the KO or COR as applicable.

a. Emergency Plan for Marine Activities. Prepare an Emergency Plan for Marine Activities for response to marine emergencies (see para 19-8.b). The plan must include the following: (19-7.a)

(1) Identification of all reasonably anticipated types of emergencies (for example, fire, sinking, flooding, severe weather, man overboard, hazardous material incidents).

(2) Procedures for responding to all type of identified emergencies.

(3) Assignments of personnel and their roles and responsibilities. Include procedures to ensure personnel are trained in their assigned roles.

(4) Procedures for conducting required drills.

(5) Procedures for developing a Severe Weather Plan for Marine Activities (SWPMA) when required (see para 19-7.b).

(6) Include instructions for mustering personnel in “Abandon ship” and “man overboard” procedures.

Note. For fire, a USCG-approved fire plan meets this requirement.

b. Severe Weather Plan for Marine Activities (SWPMA). Prepare a SWPMA where floating plant, boats or other marine activities may be endangered by severe weather (for example, sudden and locally severe weather, storms, high winds, hurricanes, floods). The SWPMA must address removing or securing the plant and evacuation of personnel in emergencies to include the following: (19-7.b)

(1) A description of the types of severe weather hazards the plant, boats, or other marine activities may potentially be exposed to and the steps that will be taken to guard against the hazards.

(2) The time frame for implementing the plan using as a reference the number of hours remaining for the storm to reach the work site if it continues at the predicted speed and direction. Include the estimated time to move the plant to safe harbor after movement is started.

(3) The name and location of the safe location(s).

(4) The name of the vessel(s), type, capacity, speed, and availability that will be used to move any non-self-propelled plant or commercial towing companies, if applicable.

(5) River and tide gage readings at which the floating plant must be moved away from dams, river structures, etc., to safe areas.

(6) Method for securing equipment if not moved.

c. Float Plans. Vessel operators must prepare a Float Plan when engaged in surveying, patrolling, or inspection activities that are remote and are expected to take longer than 4 hours, or anytime an operator is traveling alone. File the plan with the boat operator's supervisor. The plan must address at least the following: (19-7.c)

(1) Vessel information (make and model or local identifier).

(2) Personnel on board.

(3) Activity to be performed and who is responsible to perform what actions.

(4) Expected time of departure, route, and time of return.

(5) Means of communication. Provide adequate means of communication.

(6) Control measures to be implemented when operating in waters covered by a small craft advisory (see para 19-6)

d. Tow Plans. Prepare a Tow Plan prior to conducting towing operations outside of a port. The plan must include the following: (19-7.d)

(1) What is being towed: name, type of vessel, characteristics (for example, length, width, draft).

(2) Owners of towed and towing vessels with contact information.

(3) Type of tow: stern, hip, or push.

(4) Riding crew: list of crew riding the tow.

(5) Special safety requirements and plan for safety briefings.

(6) Seaworthiness and hull inspection of the tow: stability, ballast type and amount, sea valves secured, and watertightness of openings.

(7) Emergency equipment and location: emergency pumps, hoses, and flooding alarms.

(8) Navigation information: departure and arrival locations, route, and communication procedures.

19-8. General Requirements.

a. Severe Weather and High Flow Precautions. (19-8.a)

(1) Prior to conducting towing operations outside of a port, submit a Tow Plan to the USACE supervisor/KO or COR according to paragraph 19-7.d.

(2) Before extended movement of floating plant and tows, conduct an evaluation of weather reports and flow conditions to ascertain that safe movement of the plant and tow can be accomplished.

(3) Evaluate weather reports and conditions before performing work or task orders to ascertain that safe working conditions exist and safe refuge of personnel is assured. When working in an exposed marine location, monitor the National Oceanic and Atmospheric Administration (NOAA) marine weather broadcasts and use other commercial weather forecasting services as may be available.

(4) All personnel on decks exposed to severe weather must wear the appropriate USCG approved PFD (that is, Types I, II, III, V) regardless of other safety devices used (see chapter 5).

(5) A sufficient number of vessels of adequate size and horsepower, each designed, outfitted, and equipped for towing service, must be available at all times to move both self- and non-self-propelled plants against tides, current, and winds during severe weather conditions.

(6) Do not operate floating plants in sea or weather conditions that go beyond the vessel's design limitations.

b. Emergency Planning. Vessels must follow USCG-applicable regulations for drills, equipment, inspections, training, and log keeping according to 46 CFR Part 199.180 and USCG COI requirements. (19-8.b)

(1) Prepare a station bill, setting forth the special duties and the duty station of each crewmember for various emergencies, and post it in conspicuous locations throughout the vessel.

(2) Provide each crewmember with a written description of their emergency duties and ensure that they are familiar with them and the vessel's emergency signals.

(3) On all floating plants that have a regular crew or on which people are quartered, conduct the following drills at least monthly during each shift, unless the vessel is required by USCG regulations to be drilled more frequently: abandon ship/boat drills, fire drills, and person overboard or rescue drills.

(a) Conduct the first set of drills within 24 hours of the vessel's occupancy or commencement of work.

(b) Where crews are quartered at night, include night drills within every four sets of drills. Conduct the first set of night drills within the first two weeks of the vessel's occupancy.

(c) Drills must include, where appropriate, how to handle a pump shell or pipe rupture or failure within the hull (for example, proper shutdown procedures, system containment), how to handle leaks or failures of the hull or portions of it (for example, what compartments to secure, how to handle power losses, pulling spuds to move to shallow water), and how to set up and operate portable emergency pumps.

(4) Conduct person overboard or rescue drills at least monthly at boat yards, locks, dams, and other locations where marine rescue equipment is required.

(5) Operate and inspect emergency lighting and power systems at least monthly to ensure proper operation.

(a) Operate under load all internal combustion engine driven emergency generators for at least two hours each month.

(b) Test storage batteries for emergency lighting and power systems at least once every two months.

(6) Record all drills and emergency system checks, including any deficiencies noted in equipment and corrective action taken, in the station bill.

(7) Assign at least one person to be on watch on all floating plants where personnel are quartered to guards against fire and provide watch person service. In lieu of a watch person, an automatic fire detection and fire and emergency warning system(s) can be used. (See para 19-8.c)

c. Equipment Requirements. (19-8.c)

(1) Provide fenders to prevent damage and sparking and to provide safe areas for workers exposed to pinching situations caused by floating equipment.

(2) Provide potable drinking water on all floating vessels according to 40 CFR 141 and NAVMED P-5010-6 from a potable water source which meets the federal and state requirements or, if generated on the vessel, the water is tested to ensure compliance with federal and state drinking water requirements (see para 35-8.b).

(a) Dedicate all hoses, pumps, and valves to be used potable drinking water only. Rinse before each use.

(b) Before connecting at shore side, flush the supply water for at least 30 seconds.

(c) After transfer is complete, first remove the vessel hose, then remove the shore side hose, then again flush the water supply source, and finally cap the source.

(d) Drain all hoses, pumps, and valves after each use.

(e) Chemically or mechanically disinfect the storage tanks on vessels when the water fails to meet two consecutive drinking water tests.

(3) Keep axes or other emergency cutting equipment on towing vessels and other floating plants (for example, work barges, floating cranes) sharp and locate them in accessible positions for immediate use (for example, freeing lines).

(4) Provide signal devices on all vessels to give signals required by the navigation rules applicable to the waters on which the vessel is operated.

(5) Locate all controls requiring operation in cases of emergency (for example, boiler stops, safety valves, power switches, fuel valves, alarms, fire extinguishing systems) so that they are protected against accidental operation but are readily accessible in an emergency.

(6) Electric lights used on or around gasoline and oil barges or other marine locations where a fire or explosion hazard exists must be explosion-proof or approved as intrinsically safe.

(7) Install and maintain general alarm systems on all floating plants where it is possible for either a passenger or crewmember to be out of sight or hearing from any other person.

(a) Where general alarm systems are used, operate them from the primary electrical system with standby batteries on trickle charge that will automatically furnish the required energy during an electrical-system failure.

(b) Place a sufficient number of signaling devices on each deck so that they can be distinctly heard above the normal background noise and seen at any point on the deck.

(c) Interconnect all signaling devices so that actuation can occur from at least one strategic point on each deck.

(8) Smoke alarms are required in all living quarters on floating plants. If wired, the smoke alarms should use the same electrical system as that of the electrical alarms.

(9) For floating plants with internal combustion engines, install and maintain marine quality listed CO monitors in all enclosed occupied spaces (for example, crew quarters, pilot houses).

(10) All doors must be capable of being opened from either side and provided with positive means to secure them in both the open and closed position.

(11) Mark all escape hatches and emergency exits on both sides with letters at least 1 inch (2.5 cm) high stating "EMERGENCY EXIT - KEEP CLEAR".

(12) Each prime mover (for example, engine, turbine, motor) driving a dredge pump must be capable of being stopped by controls remote from the prime mover locations.

(13) Shore powered receptacles must have a grounding conductor to prevent potential difference between the shore and the vessel.

(14) Provide all electrical circuits in toilet or shower spaces, galley, machinery spaces, weather deck, exterior, or within 3 feet (0.9 m) of any sink and fit them with GFCI protection (see chapter 11).

(a) Connect all cord connected equipment used in any of these areas to an outlet with GFCI protection.

(b) Conspicuously mark ground-fault protected receptacles as "GFCI PROTECTED."

(15) Where appropriate, vessels should have watertight compartments readily identified and properly maintained in a watertight condition (that is, sealable doors in place, fully functional). Maintain penetrations in a watertight condition.

(16) Properly guard all reciprocating, rotating, and moving parts of winch gears and other equipment.

(17) Outfit and operate all self-propelled vessels conducting independent hydrographic survey work in or near a commercial channel or shipping fairway and in a manner likely to restrict or affect navigation of other vessels, with an Automatic Identification System (AIS).

Note. Small vessels supporting active dredging operations that are not normally dedicated to survey work but performing temporary hydrographic survey work, are not required to carry AIS.

d. Fuel Systems and Fuel Transfers. Floating plant fuel systems and fuel transfer operations must be performed according to 33 USC Subchapter I, as applicable. (19-8.d)

(1) Do not install gauge glasses or trycocks on fuel tanks according to 46 CFR 58.50.

(2) Install a shutoff valve at the fuel tank connection. Locate the valve so that it can be operated from outside the compartment in which the tank is located, from outside the engine compartment, and outside the house bulkheads at or above the weather deck of the vessel.

(3) When the length of the supply pipe is greater than 6 feet (1.8 m), install a shutoff valve at the engine end of the fuel line.

(4) Equip all carburetors on gasoline engines with a backfire trap or flame arrestor.

(5) Provide all carburetors, except down-draft type, with a drip pan with flame screen that is continuously emptied by suction from the intake manifold or by a waste tank.

(6) Dike, curb, or control by other means all USCG compliant fuel and lubricant containers and tanks in order to contain the tank contents in case of leakage. Follow the leakage and discharge containment requirements of 46 CFR 98.30-17 and 33 CFR 155.320.

(7) Conduct fuel oil transfers for floating plants according to 33 CFR 155, and 33 CFR 156. For uninspected vessels, follow the USCG requirements in 33 CFR 156.120, 33 CFR 155.320, and 46 CFR 98.30-15 for fuel coupling devices and fuel oil discharge containment.

(8) Indicate the tank boundary on all decks, overheads, and bulkheads that serve as fuel oil tank boundaries with contrasting paint and label with "FUEL OIL TANK - NO HOT WORK."

e. Safe Practices. (19-8.e)

(1) Clearly mark any obstructing cables or lines that cross waterways between floating plants or between plants and mooring.

(2) Prevent accumulation of fuel and grease on floors, decks, and in bilges.

(3) Swimming or diving is prohibited, except for certified divers in the performance of their duties to prevent injury or loss of life or during required training, or as a component of ER 385-1-91 related motorboat operator training.

(4) Wading is allowed only when there are no severe underwater hazards (for example, sudden drop-offs, heavy surf above 3 feet (1 m), dangerous aquatic life). When personnel are wading, they must wear an approved PFD (see chapter 5) and be

monitored by personnel who are nearby and equipped to conduct a rescue, if needed. Discontinue wading when the feet cannot easily touch bottom, regardless of depth.

(5) Consider any person in the water as a person overboard. Take appropriate action.

(6) When barriers or blanks are installed in piping systems as a lockout procedure, use positive means (for example, protruding handles) to easily recognize their presence. Mark barriers (that is, name of installer, name of inspector, date of installation) and account for them prior to installation and subsequent to removal. (See chapter 12)

(7) Limit deck loading to safe capacity. Secure loads and provide holdbacks or rings to secure loose equipment during rough weather.

(8) Protect deck openings and other fall hazards not addressed by paragraph 19-8.j according to chapter 18.

(9) Provide safeguards, such as barriers, curbs, or other structures, to prevent front-end loaders, bulldozers, trucks, backhoes, track hoes, and similar operating equipment on floating equipment from falling into the water. Whenever this equipment is operating on deck, deck surfaces of the floating plant must remain above water and the entire bottom area of a floating plant must remain submerged. Align equipment operations on floating plants with chapters 16 and 18.

(10) Eliminate projection and tripping hazards or identify them with warning signs or distinctly mark them with safety yellow.

(11) Place deck cargo carried on fuel barges on dunnage.

(12) When two or more pieces of floating plant are being used as one unit, securely fasten them together to prevent openings between them or cover and guard the openings.

(13) When three or more floating plants are configured for stationary work, a CP must identify any openings between decks of stationary vessels or vessels and other structures that create fully enclosed water areas (that is, duck ponds) into which personnel can fall. If such openings are detected, take measures to protect personnel from the hazard.

(a) When practical, duck pond protection must consist of guardrails, nets, or other physical barriers to prevent employees from falling into the openings.

(b) When physical barriers are not practical, install ladders and ring buoys in each enclosed water area to allow personnel to self-rescue. Ladders must be a rigid type or Jacob's ladder and must be securely anchored to the vessel or structure. Ring buoys

must have a sufficient length of rope to allow them to float on the water surface and the rope must be securely anchored to the vessel. Provide a sufficient number of ladders and ring buoys and place them so that the maximum swimming distance to them is no more than 25 feet (7.6 m). Ladders and ring buoys may be retracted during reconfiguration or movement of the plant.

(14) Clearly identify anchor points and inspect them prior to applying a load or putting cables under tension. Cut out, remove, or weld over structurally unsound anchor points to preclude usage. Make visual checks and sound “all clear” warnings prior to tensioning cables.

(15) Make provisions to protect persons being transported by water from the elements.

(16) Designate within plant fleeting areas where all idle plants must be moored. Mark areas with warning buoys, signs, and lights in prominent locations.

(17) The USACE supervisor/KO or COR must provide information to the local USCG Office identifying the marine activity and hazards.

(18) Use mechanical means such as securing pins to hold spuds safely in place before transiting from one site to another.

(19) Perform work inside confined and enclosed spaces in ships and vessels according to chapter 34.

(20) When there is a potential for marine activities to interfere with or damage utilities or structures, including those underwater, conduct a survey to identify the utilities or structures in the work area and the recommended steps to be taken to prevent interference or damage.

f. Life Rings and Ring Buoys. (19-8.f)

(1) On USCG-inspected vessels, ring buoys must have automatic floating electric water lights according to 46 CFR 160.

(2) On all other floating plants, lights on life rings are required only in locations where adequate general lighting (for example, floodlights, light stanchions) is not provided. For these plants, at least one life ring and every third one thereafter must have an automatic floating electric water light attached.

(3) Life rings (that is, rope attachment not required) and ring buoys (that is, rope attachment required) must be USCG-approved and must have at least 60 feet (18.3 m) of five-sixteenth (5/16) inch (7.9 mm) solid braid polypropylene line, or equivalent, attached to the ring buoy. Throw bags may be used in addition to life rings or ring buoys. Store them in such a manner as to allow immediate deployment and so they are

protected from degradation from weather and sunlight. Make life rings or ring buoys readily available and provide them at the following places:

(a) On all motorboats up to 26 feet (7.9 m) in length, at least one 20 inches (50.8 cm) in diameter.

(b) On all motorboats greater than 26 feet (7.9 m) and up to 65 feet (19.8 m) in length, at least one 24 inches (61 cm) in diameter.

(c) On all motorboats greater than 65 feet (19.8 m) in length, a minimum of three life buoys of not less than 24 inches (61 cm) and one additional for each increase in length of 100 feet (30.5 m) or fraction thereof.

(4) For additional life ring requirements during stationary work from floating plant, see paragraph 19-8.e.

g. Ventilation. (19-8.g)

(1) Equip motor vessels or boats powered by internal combustion engines having electric spark ignition systems or having auxiliary engines of this type in cabins, compartments, or confined spaces with an exhaust fan(s) for ventilating engine space and bilges.

(2) Provide at least two ventilators fitted to remove any flammable or explosive gases. The ventilators must have fans capable of ventilating each machinery space and fuel tank compartment, including bilges. Ventilators are not required for vessels constructed with the greater portions of the bilges open or exposed to the natural atmosphere at all times.

Note. This requirement does not apply to diesel engines.

(3) Adequately ventilate living spaces, including the galley, in a manner suitable to the purpose of the space.

(4) For launches and motorboats having diesel power plants not equipped with fans, ventilate by natural draft through permanently open inlet and outlet ducts extending into the bilges. Equip inlet and exhaust ducts with cowls or exhaust heads.

(5) For launches, motorboats (for example, survey boats), and skiffs having deck-mounted internal combustion engines (for example, generators, jigger pumps) and not equipped with fans, locate the exhaust piping away from personnel spaces to minimize CO infiltration in the workspace.

(6) Vent and ventilator requirements.

(a) Fans must be rated for Class I hazardous locations and located as remotely from potential explosive areas as practical (see chapter 11).

(b) The vent intake must extend to within 1 foot (0.3 m) of the bottom of the compartment.

(c) In case of fire, provide means for stopping fans in ventilation systems serving machinery components and for closing doorways, ventilators, chases, and annular spaces around tunnels and other openings from outside these spaces.

(7) Do not start engines until the engine space and bilges have been ventilated to remove fuel vapor.

h. Access. (19-8.h)

(1) General.

(a) Secure, guard, and maintain means of access free of slip and trip hazards (see chapter 24).

(b) Provide non-slip surfaces on working decks, stair treads, ship ladders, platforms, catwalks, and walkways, particularly on the weather side of deck doorways.

(c) Do not use double rung or flat tread type Jacob's ladders unless no safer form of access is practical. When in use, they must hang without slack and be properly secured.

(d) Vertical ladders must comply with ASTM F1166.

(e) No more than one person at a time can climb a ladder between the same set of rails.

(2) Access To/From Vessels.

(a) Provide safe means for boarding or leaving a floating plant, to include guarding, to prevent persons from falling or slipping. Avoid walking on rip-rap, where practical.

(b) Wherever there is a break of 19 inches (48.3 cm) or more in elevation at personnel points of access, provide a stairway, ladder, ramp, gangway, personnel hoist, or other safe means of access.

(c) Ramps for access of equipment and vehicles to or between vessels must be of adequate strength, be provided with sideboards, and be well maintained.

(d) Gangways and ramps must be:

(d-1) Secured at one end by at least one point on each side with lines or chains to prevent overturning.

(d-2) Supported at the other end in such a manner to carry them and their normal load during use in the event they slide off their supports.

(d-3) Placed at an angle no greater than that recommended by the manufacturer.

(d-4) Provided with a standard guardrail. Toe boards are optional depending on their usefulness and the hazard involved. (See chapter 21)

(3) Access on Vessels.

(a) Provide vertical access between various decks by means of stairs, ramps, or vertical ladders installed according to ASTM F1166.

(b) Do not pass fore and aft, over, or around deck loads unless there is a safe passage.

(c) If cargo or materials are stored on deck of barges, scows, floats, etc., do not use the outboard edge as a passageway unless at least 2 feet (0.6 m) of clearance is maintained.

(d) Limit vessel loads so that access and passageways in use will remain above the waterline. Except in an emergency, do not use decks and passageways for access if submerged or subject to constant breaking waves.

(4) Emergency Access.

(a) Equip vessels not easily boarded from the water with the following:

(a-1) At least one portable or permanent ladder of sufficient length to allow a person to self-rescue by boarding the ladder from the water.

(a-2) Other methods or means designed to assist in the rescue of an incapacitated person overboard.

(b) Provide two means of escape for normal work, assembly, sleeping, and messing areas on floating plants.

(c) Maintain means of access safe and functional.

(5) Access on Floating Pipelines.

(a) Equip floating pipelines used as accessways with a walkway and handrail on at least one side (see chapter 24).

(b) Walkways must be at least 20 inches (50.8 cm) wide and anchored to the pipeline.

(c) Personnel on pipelines must wear PFDs at all times (see chapter 5).

(d) When walkways and handrails are not provided (that is, the pipeline is not intended for access), barricade the pipeline at both ends to prevent access by anyone.

i. Marine Fall Protection Systems. (19-8.i)

(1) On decks or work surfaces 6 feet (1.8 m) or more above the main deck or adjacent vessel decks, docks, or other hard surfaces, provide Railing Type A or Type B according to paragraph 19-8.k., or bulwarks, coamings, or other structures meeting the height and strength requirements of these railing systems, except as excluded in paragraphs 19-8.i(3) and 19-8.i(4).

(2) Provide deck edge toe boards at least 3.5 inches (8.9 cm) high for Type A and 2 inches (5.1 cm) high for Type B railings when the railings are used for fall protection. Toe boards must meet the strength requirements in chapter 21. Install scuppers and/or drainage holes as needed if the top edge of the toe board is intact and the strength requirements are retained.

(3) When railing systems are not installed, use personal fall protection systems according to chapter 21.

(4) Railing systems and personal fall protection systems are not considered feasible on the main deck of vessels that perform duty cycle material loading and unloading operations from barges, scows, or other vessels alongside.

j. Main Deck Perimeter Protection. (19-8.j)

(1) Provide main deck perimeter protection on all manned vessels according to paragraph 19.8.k. See paragraph 19-8.j(5) for applicable exceptions to this requirement.

(2) Provide manned vessels over 26 feet (7.9 m) in length operating in unprotected or partially protected waters, as defined in 46 CFR 175.400, with Type B Railings around the deck edge, except where excluded in paragraph 19-8.j(5).

(3) Provide manned vessels over 26 feet (7.9 m) in length operating in rivers or protected waters with Type B or Type C Railings around the deck edge, except where excluded in paragraph 19-8.j(5).

(4) Provide Type D Grab Rails on all manned vessels in the following instances:

(a) On deckhouses or other similar permanent structures more than 48 inches (121.9 cm) from deck edge rail systems.

(b) On deckhouses or similar permanent structures that are within 8 feet (2.4 m) of the deck edge in areas where the deck edge rail has been omitted or temporarily removed according to paragraph 19-8.j(5).

(5) The following are main deck areas where perimeter protection may be omitted or temporarily removed:

(a) Deck perimeter rails may be omitted from deck work areas specifically intended for line handling, working over the side of the vessel, load handling operations, and designated boarding areas. Railings in these areas may obstruct work or access and present additional hazards such as pinch points against railings. Such deck edge areas may include those for line handling, fleeting scows, mooring vessels, towing, pile driving activities, and handling or placing of construction materials and equipment pipelines and anchors.

(b) Deck perimeter rails may be omitted from main deck areas where the overall walkway width is less than 2 feet (0.6 m) between deck structures or permanent equipment and the deck edge.

(c) Removable perimeter rail sections may be installed in areas where activities such as working over the side of the vessel or loading operations are performed. Maintain these rails in place when vessel operations do not include activity in these areas or during periods of tie-up or inactivity.

(6) When deck-edge perimeter protection is not present, develop standard operating procedures, AHAs, or other documents to address the hazards involved and the controls to be implemented to prevent persons from falling. All crew members must review these documents during initial orientation and at regular intervals thereafter. The following operational procedures must be followed:

(a) Personnel must wear PFDs in areas where deck perimeter protection is not present (see chapter 5).

(b) Block off areas where railings are removed from access by a suitable barrier, or clearly mark them as PFD-required areas by signage, deck markings, or other means.

(c) Maintain continuous sight and verbal or radio contact between personnel in the non-protected deck perimeter areas and the vessel operator, or a designated crew member who is in sight and verbal or radio contact with the operator and who will monitor the workers in the area.

(d) A safety skiff or equivalent rescue vessel must be readily available throughout the duration of these activities according to chapter 5.

(7) Provide boats under 26 feet (7.9 m) with integrated combinations of two or more of the below listed items to provide continuous perimeter protection around the vessel. Install them according to either ABYC Standards or ISO Standard 15085, as demonstrated by a manufacturer's certificate, label, or other documentation.

(a) Cockpits.

(b) Coamings.

(c) Handholds.

(d) Toe rails.

(e) Life rails.

(f) Deck rails.

(g) Stern rails.

(h) Bow rails.

k. Marine Railing Types. (19-8.k)

(1) Allowable types of railings on vessels (that is, A, B, C, D) are identified below. Specific requirements for the vessel types and areas where each are to be used are delineated in paragraphs 9-8.i and 19-8.j.

Note. Solid bulwarks or coamings providing equal perimeter protection to a height of 39 in (1 m) may also be provided. Bulwarks may be constructed of structural plate and shapes. Bulwarks must meet all strength, deflection, and open spacing requirements presented below for Type B railings.

(2) Railing Type A: Two-Tier Rigid Fall Protection Rail. This railing type must meet the requirements of a guardrail system according to chapter 21 (see figure 19-1).

(3) Railing Type B: Three-Tier Marine Rigid or Tensioned Railing. This railing is comprised of rigid vertical stanchions and three rigid or tensioned horizontal tiers and must meet the following (see figure 19-2):

(a) Clear spacing between tiers must be no greater than 9 inches (22.9 cm), 15 inches (38.1 cm), and 15 inches (38.1 cm), respectively, where the 9 inches (22.9 cm) space is closest to the deck surface. The height from the deck to the top tier must be at least 39 inches (99 cm).

(b) The bottom tier may be omitted if it is in the way of deck fittings or to facilitate line handling. The space resulting from the removed lower tier cannot extend more than 2 feet (0.6 m) beyond either side of the deck fitting.

(c) Vertical stanchions must be pipe or structural sections. Horizontal tiers must be constructed from rigid (for example, pipe, structural sections) or non-rigid (for example, wire rope, chain) components or from combinations of these components. Tension non-rigid tiers with turnbuckles or similar components.

(d) Railings may be either fixed or removable in sections. All vertical stanchions must be adequate to withstand a 200 lbs. (90.7 kg) load applied horizontally at the top of the stanchion and be spaced no more than 8 feet (2.4 m) apart.

(e) Size pipe and structural section rail components appropriately to meet the performance criteria of chapter 21.

(f) Chain or wire rope and all the associated connection fittings together must have minimum breaking strength of 4,000 lbs. (1814.4 kg).

(g) Tension the chain or wire rope horizontal tiers so that:

(g-1) There is no slack.

(g-2) Sag does not exceed one-quarter ($\frac{1}{4}$) inch (0.6 cm) at any point between stanchions.

(g-3) The lowest point from deck to the top of the upper rail is not less than 39 inches (99 cm) at any point between the stanchions. Tensioned railing tiers must not deflect more than 1 inch (2.5 cm) under a load of 200 lbs. (90.7 kg).

(4) Railing Type C: Non-Tensioned Railings and Flexible or Swing-Away Railings. This railing must consist of rigid vertical stanchions with horizontal non-tensioned chain, wire rope, or rigid tiers that clip to the verticals (see figure 19-3).

(a) Non-Tensioned Railings must consist of horizontal tiers constructed from chain, wire rope, pipe, or structural sections or combinations of these components.

Vertical stanchions must be pipe or structural sections. Vertical support spacing must not exceed 8 feet (2.4 m).

(b) Flexible or Swing-Away Rails must consist of chain or wire rope tensioned vertical support lines with non-tensioned chain, wire rope, or clip-on rigid horizontal tiers. Vertical support line spacing must not exceed 6 feet (1.8 m).

(c) Size pipe or structural section rail components appropriately to meet the performance criteria of chapter 21. Chain or wire rope and all the associated connection fittings together must have minimum breaking strength of 4,000 lbs. (1814.3 kg).

(d) For Non-Tensioned Railings and Flexible or Swing-Away Railings, sag of horizontal tiers must not exceed 3 inches (7.6 cm) between vertical supports.

(e) Configure Non-Tensioned Railings and Flexible or Swing-Away Railings with four or more horizontal tiers. The number of horizontal tiers must be sufficient to meet the following requirements:

(e-1) Effective clear spacing between the deck and bottom tier is no greater than 9 inches (22.9 cm).

(e-2) Effective clear spacing between all tiers above the bottom tier is no greater than 15 inches (38.1 cm).

(e-3) Effective minimum height from deck to the top tier must be at least 39 inches (99 cm).

(f) The effective tier spacing includes the effect of the increased spacing associated with sag in the tiers, applied either up or down. Make clear spacing measurements with the railing tiers spread to form the largest opening.

(g) To account for the sag, measure for the minimum railing height at the lowest point in the rail.

(h) The bottom tier may be omitted in way of deck fittings or to facilitate line handling. The space caused by the removed lower tier cannot extend more than 2 feet (0.6 m) beyond either side of the deck fitting.

(i) The top tier must not deflect to a height less than 39 inches (99 cm) above the deck under a force of 200 lbs. (90.7 kg), applied vertically. In addition, the top tier must not deflect more than 12 inches (30.4 cm) horizontally under a force of 200 lbs. (90.7 kg) applied horizontally.

(j) Tensioning springs in the vertical support lines, if provided, must be of the compression with drawbar type.

(5) Railing Type D: Grab Rails. Grab rails are railing sections mounted to deckhouse sides or to the sides of other permanent structures.

(a) Grab rail height must match the height of the deck top rail or tier. Where there is no top rail near the grab rail, grab rail height must be 39 inches (99 cm).

(b) Grab rail strength must be adequate to withstand a 200 lb. (90.7 kg) load applied in any direction.

(c) Size grab rails dimensionally comparable to 1.5 inch (3.8 cm) pipe. Clear distance between the rail and house side must be at least 3 inches (7.6 cm).

I. Launches, Motorboats, and Skiffs. (19-8.I)

(1) Personnel and Cargo Requirements.

(a) Post the maximum number of personnel and weight that can safely be transported on all launches, motorboats, and skiffs. The number of personnel, including crew, must not exceed the number of PFDs aboard.

(b) Each boat must have sufficient room, freeboard, and stability to safely carry the cargo and number of persons allowed with consideration given to the weather and water conditions in which it will be operated.

(c) Launches, motorboats, and skiffs less than 20 feet (6.1 m) in length must meet 33 CFR 183 requiring level floatation after flooding or swamping.

(d) Equip all open cabin launches or motorboats with engine cut-off devices (that is, "kill switches"). The vessel operator must be tethered via lanyard to the engine cut-off device and must test the device prior to each operation. Operators may supplement the lanyard tether with additional fail safes, such as wireless engine cut-off devices, but a lanyard system must be in place and used by the vessel operator while underway. Exclusive use of wireless engine cut-off devices is not authorized.

(2) Fire Protection.

(a) Equip all launches and motorboats, including outboards, with fire extinguishers according to table 19-1.

(b) Equip all launches and motorboats having gasoline or liquid petroleum gas power plants or equipment in cabins, compartments, or confined spaces with a built-in automatic CO₂ fire extinguishing system meeting the requirements of 46 CFR 25.30-15.

(3) Lifesaving and/or safety skiffs are required during construction activities where work is performed over or immediately next to water or during any operations and

maintenance activities that cause an employee to work outside the designated permanently installed safety controls (that is, guardrails).

(a) Provide personnel trained in launching and operating the skiff readily available during working hours (see para 29-3.b).

(b) Skiffs must be readily available during working hours. During construction activities, have at least one skiff immediately available at locations where employees work over or immediately next to water. Skiffs must be kept afloat or ready for instant launching.

(c) Lifesaving personnel must perform a lifesaving drill, including the launching and recovery of the skiff before the initiation of work at the site and periodically thereafter as specified by the USACE supervisor/KO or COR (but at least monthly or whenever new personnel are involved).

(d) Required equipment must be on board and meet or exceed USCG requirements and the requirements of this chapter. Skiffs must be equipped as follows:

(d-1) Four oars, or two if the skiff is motor powered.

(d-2) Oarlocks attached to gunwales or the oars.

(d-3) One ball-pointed boat hook.

(d-4) One ring buoy with 60 feet (18.3 m) of three-eighths (3/8) inch (0.9 cm) solid braid polypropylene, or equivalent, line attached.

(d-5) PFDs in number equaling the skiff rating for the maximum number of personnel allowed on board.

(d-6) One 1-A:10B:C fire extinguisher.

(d-7) In locations where waters are rough or swift, or where manually operated boats are not practical, provide a power boat suitable for the waters and equip it for lifesaving.

(d-8) Skiffs and power boats must have buoyant material capable of floating the boat, its equipment, and the crew.

(d-9) Equip vessels without permanently mounted navigation lights (for example, skiffs), with portable battery-operated navigation lights and use them during night operations.

m. Dredging. (19-8.m)

(1) Prior to repair or maintenance on the pump, suction, or discharge lines below the water line or within the hull, raise the ladder (that is, drag arm) above the waterline and positively secure it. This provision is in addition to the normal securing of hoisting machinery. Blank or block plates must also be set in suction or discharge lines, as appropriate.

(2) Dredge pipelines that are floating or supported on trestles must display appropriate lights at night and in periods of restricted visibility according to USCG regulations and 33 CFR 83.27.

(3) Submerged and Floating Dredge Pipeline.

(a) Where a pipeline crosses a navigation channel, the pipeline must be submerged and any anchor securing the pipeline must rest on the channel bottom. Provide the depth of the submerged pipeline to the USCG for publication.

(a-1) Whenever buoyant or semi-buoyant pipeline is used, the dredge operator must assure that the pipeline remains fully submerged and on the bottom. Whenever it is necessary to raise the pipeline, maintain proper clearances and adequately mark the entire length of the pipeline.

(a-2) Mark submerged pipelines according to local USCG requirements and as required by the USACE supervisor/KO or COR.

(a-3) Unless otherwise specified by the USCG, submerged pipelines require special marks and must have a USCG-approved flashing yellow light.

(a-4) Place indicators, such as signs or buoys that state "DANGER SUBMERGED PIPELINE" at the beginning and end of the pipeline.

(a-5) In addition, indicators are required beginning in areas which reduce the charted depth by more than 10%, and, as a minimum, every 1000 feet (304.8 m) to clearly warn of the pipeline length and course.

(a-6) If barges or other vessels are used to anchor the beginning or end of the submerged pipeline, they must be lighted according to 33 CFR 83.30.

(a-7) Within a navigation channel, identify each end of the pipeline with a regulatory marker buoy.

(a-8) Identify lengths of submerged pipeline that are located outside of the navigation channel and that reduce the charted depth by more than 10 percent with high visibility buoys marked with 360-degree visibility retro-reflective tape. An acceptable

arrangement is orange neoprene buoys placed at an interval not to exceed 500 feet (152.4 m) that clearly show the pipeline length and course.

(a-9) Conduct routine inspections of the submerged pipe to ensure anchorage.

(a-10) Remove all anchors and related material when the submerged pipe is removed.

(b) Floating pipeline is any pipeline that is not anchored on the channel bottom. Pipelines must be either fully floating or fully submerged. Do not allow pipelines to fluctuate between the water surface and the channel bottom.

(c) Mark all pipelines with the owner's name for positive identification in the event of loss (that is, adrift) or damage to vessels operating in the area.

(4) Identification and avoidance of submerged and buried pipelines and obstructions.

(a) Prior to the start of any dredging, the dredger must conduct a thorough investigation to identify any underwater or underground pipeline utility lines that exist within the project area, to include the navigation channel, its set back, and the dredged material placement facility. Verify all pipeline information provided in USACE contract documents.

(b) Precautionary measures such as no spud, no anchor, no dredge, and tolerance zones must be understood, agreed to, and in place before the project begins. Communicate these zones on all project documents and strictly enforce them during the project.

(c) Identify temporary submerged obstructions and dangers, such as anchors and supporting rigging, and review them at least once per shift, if not more often as the situation changes.

(5) Design dredges so that a failure or rupture of any of the dredge pump components, including dredge pipe, will not cause the dredge to sink. Make the data or plans supporting this capability available to the USACE supervisor/KO or COR upon request.

(6) A QP must perform mobilization, demobilization, and relocation of dredges, support barges, support tenders, tugs, and heavy equipment.

(7) Hopper dredges must offer a safe means and process to load and unload personnel.

(8) Any dredge that has a dredge pump below the waterline must have a bilge alarm or shutdown interface.

(9) Secure covers of "stone boxes" with at least two positive means when the boxes are working under positive pressure.

(10) Dredge Disposal Sites.

(a) Drinking water. Provide an adequate supply of drinking water at all dredge disposal sites according to chapter 35. Provide cool water during hot weather.

(b) Toilet facilities. Provide toilet facilities according to the requirements of chapter 35.

(c) Medical and first-aid requirements. Provide first-aid and CPR trained personnel and medical equipment according to chapter 3 at all disposal areas.

(d) Operate amphibious excavators according to the manufacturer's operating instructions. Keep a copy of the operator's manual with the equipment. (See chapter 18)

(e) Lighting. Provide lighting according to chapter 7 of this manual. The minimum lighting level in the vicinity of the disposal site shelter (that is, dump shack) is 5 foot-candles.

(f) Disposal Site Shelters (Dump Shacks)

(f-1) Provide disposal site shelters (dump shacks) to protect personnel from inclement weather and environmental hazards. The shelter must be large enough to accommodate a minimum of four workers. The shelter must have adequate seating for the workers, heating equipment, water cooler, and space to store all hand tools and PPE. The shelter must be weather tight with operable windows with screens for ventilation.

(f-2) All electrical systems must comply with the NFPA 70 (NEC). All flexible electrical cords must be hard usage or extra-hard usage. All frayed, patched, oil-soaked or worn electrical cords must be taken out of service. (See chapter 11)

(f-3) Portable generators used for lighting must comply with the requirements of chapter 11 of this manual and must be located downwind of shelters.

(f-4) Do not use fossil fuels for heating.

(f-5) Cover all rigid insulation with a non-combustible material to prevent accidental ignition.

(f-6) Equip all shelters with a minimum of one multi-purpose fire extinguisher (see chapter 9).

n. Scows and Barges. (19-8.n)

(1) Equip scows that dump in open ocean waters with remote opening devices to preclude the transfer of personnel between the vessels.

(2) Provide a safe means for transferring personnel between the towing vessels and scow according to paragraph 19-8.h(2).

(3) Identify general and site-specific adverse weather and water conditions (for example, currents) under which the towing of scows or cargo barges is prohibited.

(4) All barges and scows that are used as deck cargo barges must comply with 46 CFR Subpart B for intact stability of deck cargo barges.

(5) Use personal fall protection devices or other fall protection according to chapter 21 and paragraph 19-8.i on all scows and open barges to prevent personnel transiting between the stern and bow of the vessel from falling into the hopper or falling off the side of the vessel to structures (for example, dock, vessels) located 6 feet (1.8 m) or more below.

o. Navigation Locks and Vessel Locking. (19-8.o)

(1) Smoking, open flames, or other ignition sources is prohibited on lock structures within 50 feet (15.2 m) of vessels containing hazardous cargos of flammable or other HAZMAT (that is, "Red Flag" vessels) during approach and lockage.

(a) When construction, maintenance, and other non-navigational related activities are taking place on or adjacent to the lock structure, the supervisor will relay information to supervisory personnel in these activities regarding the approach and passage of Red Flag vessels.

(b) Prior to the start of work on these activities, the Work Crew Supervisor must establish safe zones that maintain at least the minimum 50 feet (15.2 m) required distance between Red Flag vessels and sources of ignition such as hot work and smoking areas.

(b-1) Calculate the minimum distance vertically and horizontally throughout a lock chamber when the chamber is pumped out for maintenance.

(b-2) Mark, barricade, or otherwise designate these zones so that personnel can easily distinguish them.

(b-3) Include the location of and the restricted activities within these zones in the AHA and discuss them with workers prior to start of work.

(2) Lockage of Red Flag Vessels.

(a) Do not lock pleasure and commercial recreational craft through a lock chamber with Red Flag vessels.

(b) When river traffic in the approach to a lock is light, do not simultaneously lock two Red Flag Vessels or tows, or simultaneously lock another vessel or tow carrying non-dangerous cargoes with a vessel or tow carrying dangerous cargoes.

(c) When the river approach to a lock is congested, simultaneous lockage of the aforementioned vessels or tows, other than pleasure craft, may be permitted provided the following conditions are met:

(c-1) The first vessel or tow entering and the last vessel or tow exiting are secured before the other enters or leaves.

(c-2) Any vessel or tow carrying dangerous cargoes is not leaking.

(c-3) All Masters involved have agreed to the joint use of the lock chamber.

19-9. Figures and Tables.

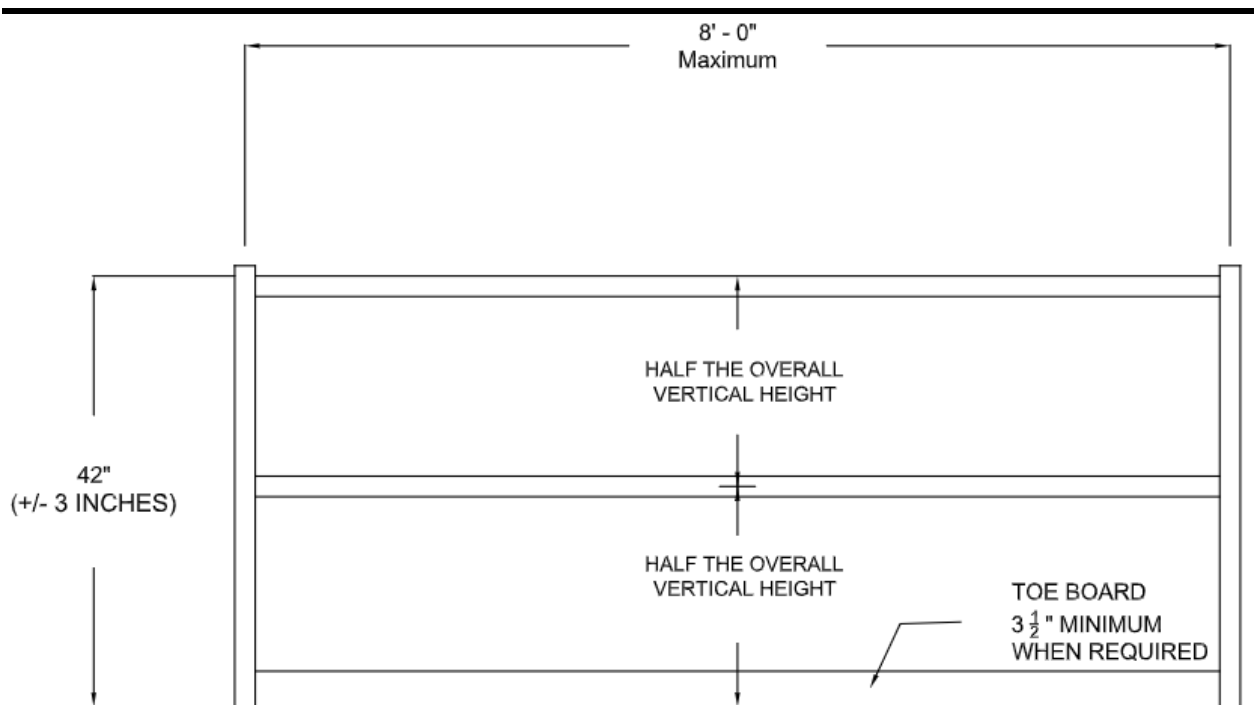

Figure 19-1. Railing Type A, Two Tier Rigid Fall Protection Railing

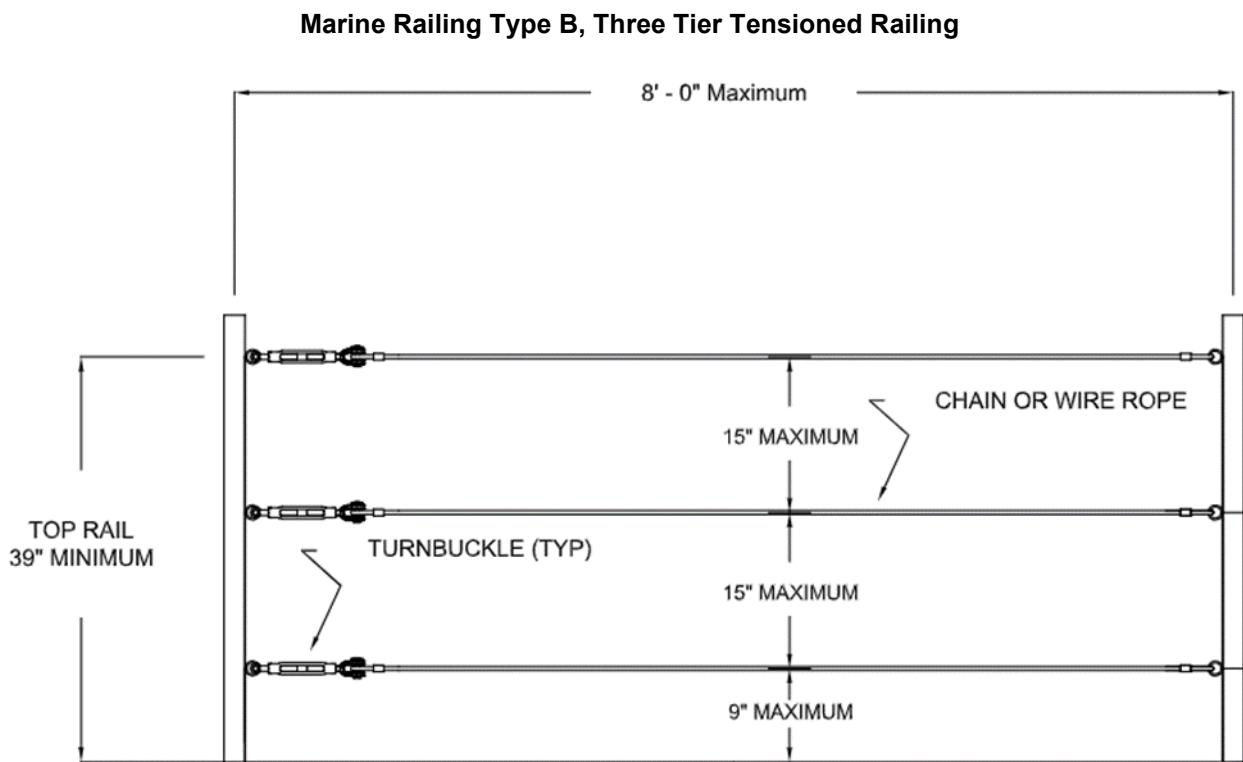
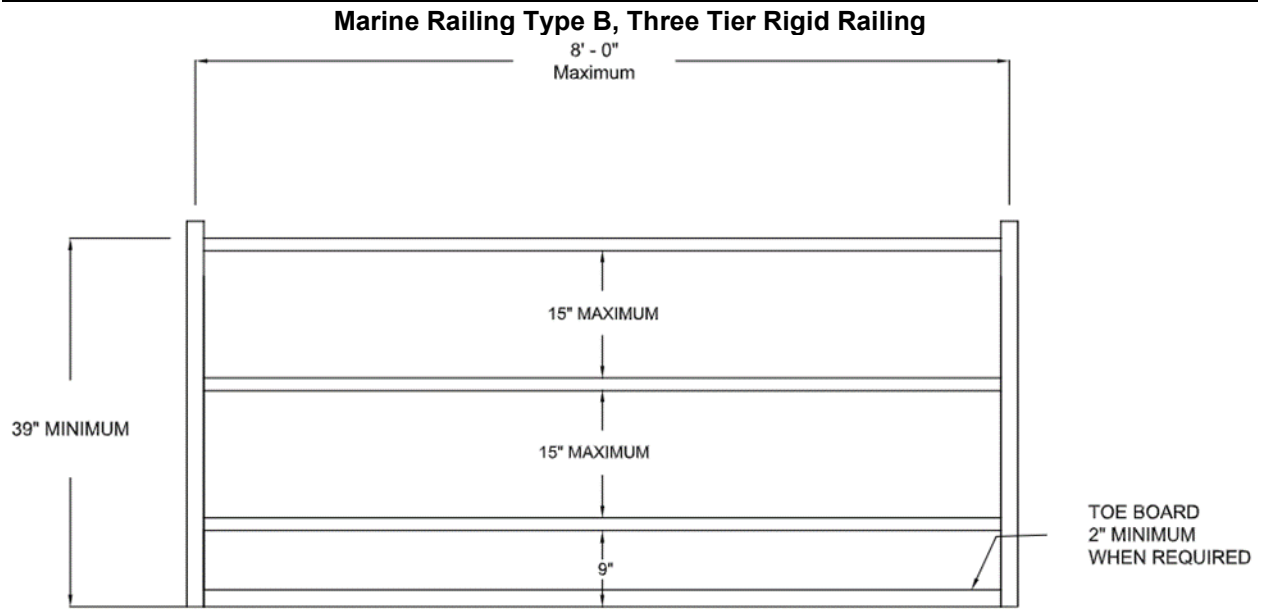
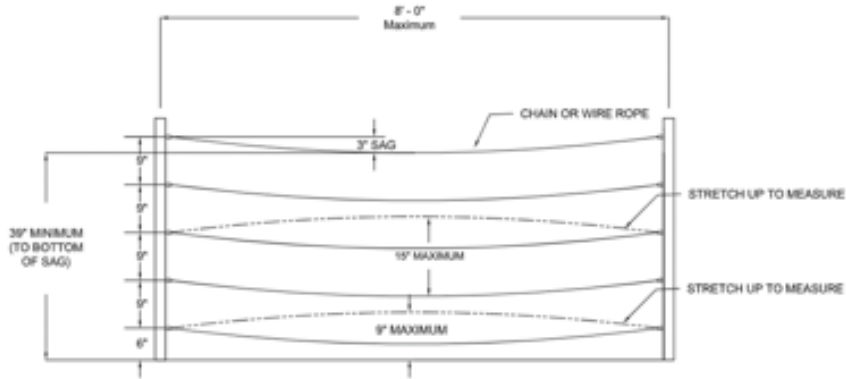
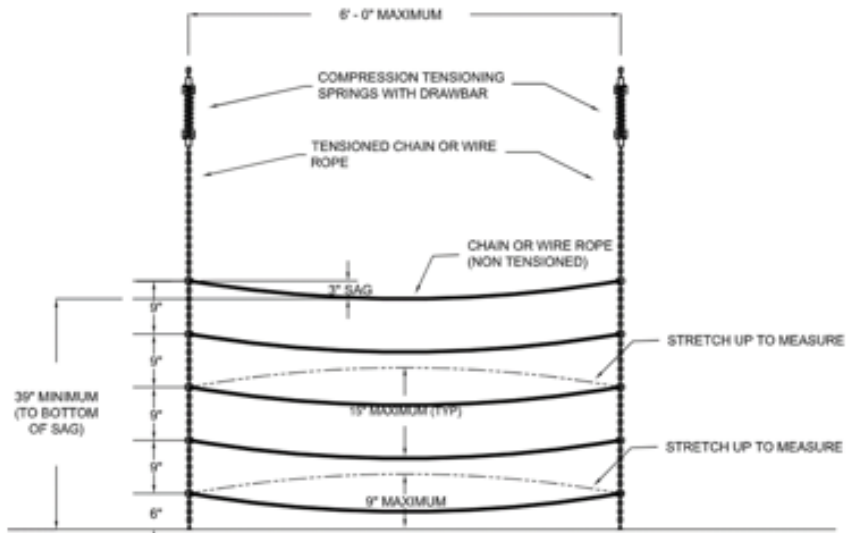

Figure 19-2. Marine Railing Type B

Marine Railing Type C, Non-Tensioned Railing (3" sag shown)



Marine Railing Type C, Flexible/Swing-Away Railing with Flexible Tiers (3" sag shown)



Marine Railing Type C, Flexible/Swing-Away Railing with Rigid Tiers

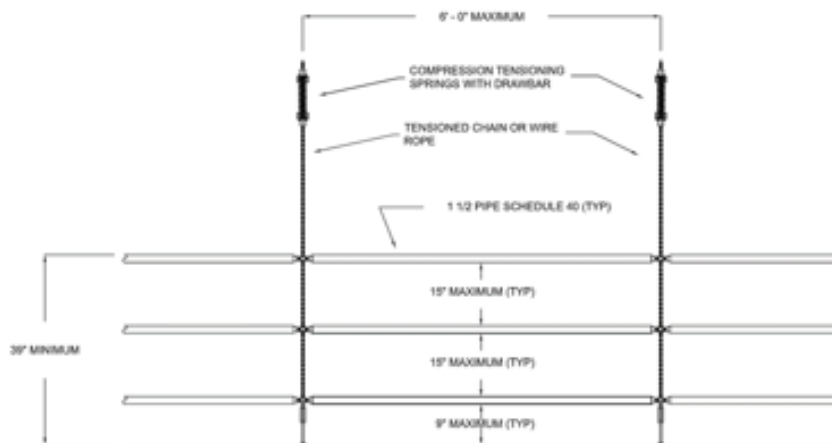

Figure 19-3. Marine Railing Type C

Table 19-1.
Fire Extinguisher Requirements for Launches/Motorboats

Length	Extinguisher
Less than 26 feet (7.9 m)	One 1-A:10-B:C
26 feet (7.9 m) or more	Two 1-A:10-B:C

19-10. Checklists and Forms.

ENG Form 6175, Small Boat (Less Than 26 Feet) and Equipment Checklist
(<https://www.publications.usace.army.mil/USACE-Publications/Engineer-Forms>)

Chapter 20

Pressurized Equipment and Systems

20-1. References.

- a. ASME B31, Code for Pressure Piping (<https://www.asme.org>) (20-1.a)
- b. ASME B31Q, Pipeline Personnel Qualification (<https://www.asme.org/>) (20-1.b)
- c. ASME, Boiler and Pressure Vessel Code (BPVC) (<https://www.asme.org/>) (20-1.c)
- d. ASME, Code for Unfired Pressure Vessels (<https://www.asme.org/>) (20-1.d)
- e. CGA C-6, Standard Visual Inspection of Steel Compressed Gas Cylinders (<https://portal.cganet.com/Publication/index.aspx>) (20-1.e)
- f. CGA C-8, Standard for Requalification of DOT-3HT, CTC-3HT, and TC-3HTM Seamless Steel Cylinders (<https://portal.cganet.com/Publication/index.aspx>) (20-1.f)
- g. CGA P-1, Standard for Safe Handling of Compressed Gases in Containers (<https://portal.cganet.com/Publication/index.aspx>) (20-1.g)
- h. MIL-STD 101B, Color Code for Pipelines and for Compressed Gas Cylinders (<https://webstore.ansi.org/>) (20-1.h)
- i. National Board of Boiler and Pressure Vessel Inspectors (NBBI), National Board Inspection Code (NBIC) (<https://www.nationalboard.org/index.aspx?pageID=4>) (20-1.i)
- j. 49 CFR 171, General Information, Regulations, and Definitions (Hazardous Materials Regulations) (<https://www.govinfo.gov/content/pkg/CFR-2020-title49-vol2/pdf/CFR-2020-title49-vol2-part171.pdf>) (20-1.j)

k. 49 CFR 172, Hazardous Materials Table, Special Provisions, Hazardous Materials Communications, Emergency Response Information, Training Requirements, and Security Plans (<https://www.govinfo.gov/content/pkg/CFR-2020-title49-vol2/pdf/CFR-2020-title49-vol2-part172.pdf>) (20-1.k)

l. 49 CFR 173, Shippers- General Requirements for Shipments and Packagings (<https://www.govinfo.gov/content/pkg/CFR-2020-title49-vol2/pdf/CFR-2020-title49-vol2-part173.pdf>) (20-1.l)

m. 49 CFR 175, Carriage by Aircraft (<https://www.govinfo.gov/content/pkg/CFR-2020-title49-vol2/pdf/CFR-2020-title49-vol2-part175.pdf>) (20-1.m)

n. 49 CFR 176, Carriage by Vessel (<https://www.govinfo.gov/content/pkg/CFR-2020-title49-vol2/pdf/CFR-2020-title49-vol2-part176.pdf>) (20-1.n)

o. 49 CFR 177, Carriage by Public Highway (<https://www.govinfo.gov/content/pkg/CFR-2020-title49-vol2/pdf/CFR-2020-title49-vol2-part177.pdf>) (20-1.o)

20-2. Definitions.

a. Air Receiver. A tank used for the storage of air discharged from the compressor; used to help eliminate pressure pulsations in the discharge line. (20-2.a)

b. Competent Person (CP). See paragraphs 1-2 or 2-2, as applicable. (20-2.b)

c. Fuel Gas. A gas (for example, acetylene, hydrogen, natural gas, propane) used with oxygen in the oxy-fuel process and for heating. (20-2.c)

d. Fusible Plug. A device designed to relieve pressure and to indicate certain conditions that contribute to low water. (20-2.d)

e. Pressure Systems. All pipe, tubing, valves, controls, and other devices that operate or are maintained above atmospheric pressure. (20-2.e)

f. Qualified Inspector (QI). Individuals performing authorized inspections as required in the ASME BPVC. The QI may not be employed by the manufacturer. (20-2.f)

g. Qualified Person (QP). See paragraphs 1-2 or 2-2, as applicable. (20-2.g)

h. Safety Lashing. A rope, cord, chain, or other suitable material flexible lacing that is used to fasten two objects together securely and thus rendering the objects safe. (20-2.h)

i. Safety Relief Valves. Valves that relieve excess pressure or vacuum (depending on their design) that would otherwise damage equipment or cause injury to personnel. (20-2.i)

j. Unfired Pressure Vessels. Vessels that can withstand internal pressure or vacuum, but are not heated by burning fuel or electricity (heat may be generated in the vessel due to chemical reactions or the application of heat directly to vessel contents). (20-2.j)

20-3. Personnel Required Qualification/Training.

a. Qualified Inspectors (QI). QIs must be certified by an ASME accredited Authorization Inspection Agency or Qualified Inspection Organization. The QI may not be employed by the manufacturer. (20-3.a)

b. Qualified Mechanics. Mechanics who adjust or change the settings of safety relief valves must be qualified according to the ASME BPVC. (20-3.b)

20-4. Roles and Responsibilities.

a. Qualified Inspectors (QI). Perform and oversee inspections according to paragraph 20-5. (20-4.a)

b. Competent Person (CP). (20-4.b)

(1) Perform and oversee inspections according to paragraph 20-5.

(2) Develop and supervise test procedures that involve pressurized air or gases. Submit procedures to the USACE supervisor or approval or to the KO or COR for acceptance.

c. Qualified Person (QP). (20-4.c)

(1) Supervise the bleeding of compressed gas cylinders containing toxic gases.

(2) Only QPs may refill compressed gas cylinders.

20-5. Inspection Requirements.

Records of the inspections and tests must be available for review on request. Post certificates of compliance near the vessel controls prior to operation of the equipment.

a. Inspections and Tests - General. (20-5.a)

(1) Inspect and conduct performance tests on pressurized equipment and systems before placing them in service and after any repair or modification.

(a) New pressure vessels. Conduct inspections of pressure vessels prior to placing in service according to the ASME BPVC.

(b) In-service pressure vessels. Conduct inspections of in-service pressure vessels according to the NBBI/NBIC.

(2) If not otherwise specified by state or local codes or the manufacturer, the QI will determine inspection frequency and document the inspections. State and local codes take precedent for inspection frequency.

(3) A CP must perform and document visual inspections of pressurized equipment. Inspect temporary or portable pressurized equipment and systems at least once every six months and permanent installations at least annually.

b. Hydrostatic Testing of In-Service Pressure Vessels. (20-5.b)

(1) Unless otherwise specified by state or local codes, perform hydrostatic testing of in-service unfired pressured vessels as follows:

(a) After any repairs or modifications that may affect the integrity of the system or its ability to maintain stored pressure, as determined by the QI.

(b) According to the manufacturer's instructions or a QI's recommendations after consultation with the manufacturer.

(2) Perform hydrostatic testing on vessels with inspection doors, such as oil filled (governor) pressure tanks, whenever they are repaired or modified or appear to be deteriorating. The frequency of inspections to determine internal or external conditions will be according to the manufacturer's recommendations or as determined by a QI.

(3) The following unfired vessels are exempt from this requirement:

(a) Vessels designed for a maximum allowable pressure not exceeding 15 psi (103.4 kPa).

(b) Vessels having an internal volume of 5 ft³ (0.14 m³) or less and a maximum rated pressure of 100 psi (689.5 kPa).

(c) Compression tanks containing water under pressure not exceeding 100 psi (689.5 kPa) and temperatures not exceeding 200°F (93.3°C).

(d) Compression tanks containing water and fitted with a permanent air charging line subject to pressures not exceeding 15 psi (103.4 kPa) and temperatures not exceeding 200°F (93.3°C).

(4) Fire extinguishers (see chapter 9).

c. Boiler and Systems Inspection. (20-5.c)

(1) Inspect safety devices affecting operation of the firing equipment to determine if they are installed and located so that they cannot be isolated from the heat source by the closing of a valve.

(2) Re-inspect and post a new certificate prior to placing into operation any boilers that have undergone major structural repairs or those that have been relocated during their current 12-month certification period.

(3) Inspect steam boilers and pressure vessels according to the ASME BPVC.

d. Compressed Gas Cylinders. Visually inspect compressed gas cylinders according to 49 CFR 171–173 and 175–177 and CGA C-6, C-8, and P-1. (20-5.d)

20-6. Activity Hazard Analysis (AHA) Requirements.

Develop AHAs according to paragraphs 1-6 or 2-6, as applicable.

20-7. Minimum Plan Requirements.

Not Applicable.

20-8. General Requirements.

a. General. (20-8.a)

(1) Tag any pressurized equipment or system found to be in an unsafe operating condition as "UNSAFE PRESSURIZED SYSTEM - DO NOT USE". Locate the tag at the controls. Do not use the equipment until the unsafe conditions are corrected.

(2) Only designated personnel may operate or maintain pressurized equipment and systems.

(3) Do not operate any pressurized equipment or systems above their design pressure.

(4) Do not remove or make ineffective any safety appliance or device, except for when making immediate repairs or adjustments. Ensure that the pressure is relieved and the power shut off using proper LOTO procedures prior to working on the equipment or systems. (See chapter 12).

(5) Prepare a written safe clearance (that is, control of hazardous energy) procedure prior to repairing or adjusting equipment or systems under pressure (see chapter 12).

(6) Locate discharge from safety valves, relief valves, and blowoffs so that it is not a hazard to personnel.

(7) Master valves and controls must be either located or equipped to permit operation from the floor level, or they must be provided with safe access to them.

(8) Provide a pressure gauge on all pressurized equipment and systems; and maintain it in good operational condition.

(9) Provide safety and relief valves on all pressurized equipment and systems.

(a) Do not set the safety relief valve higher than the maximum allowable pressure of the receiver or the system. A safety relief valve setting not more than 10% over working pressure is recommended.

(b) Do not place valves between the pressure vessel or generating equipment and a safety or relief valve, or between the safety or relief valve and the atmosphere, unless the configuration meets the requirements of the ASME BPVC.

(c) Only qualified mechanics using appropriate equipment may adjust or change the settings of safety relief valves (see para 20-3.b). All valves must be sealed after adjusting.

(d) Check the functioning of the pressure gauge immediately if the pressure gauge registers above the maximum allowable working pressure and the safety or relief valve does not open. If the safety or relief valve is inoperative or malfunctioning, then remove the associated equipment from service until the safety or relief valve is adjusted or replaced.

(10) Piping must meet requirements of the ASME B31.

(11) Provide an automatic shut-off or other enabling device control on pressurized manual equipment that might whip or rotate if released.

(12) Except where automatic shutoff valves are used, install safety lashings or suitable double action locking devices where high-pressure hose lines connect to machines or another high-pressure line.

(13) Secure the connections to high pressure hoses with a safety lashing or whip check.

(a) Safety lashings must be made of two metal hose clamps connected by a flexible lacing. The metal hose clamps must attach to the hose ends separate from the quick makeup connection.

(b) The flexible lacing material must be suitably strong material. Wires or pins through the quick makeup connection are not acceptable for use as safety lashings.

(14) Equip all pressurized cylinders, actuating booms, outriggers, or other load supporting appliances with pilot check valves, holding valves, or positive mechanical locks to prevent movement in case of failure in the pressure system. Pressure system fitting replacement parts must be equivalent to the manufacturer's standards.

b. Compressed Air and Gas Systems. (20-8.b)

(1) Construct air receivers according to the ASME BPVC.

(2) Construct, install, test, and maintain all safety valves according to the ASME BVPC.

(3) Access and Guarding.

(a) Locate compressors and related equipment to allow safe access to all parts of the equipment for operation, maintenance, and repairs.

(b) Construct, locate, and install safety appliances, such as valves, indicating devices, and controlling devices, so that they cannot be readily rendered inoperative by any means, including the elements.

(4) Do not exceed the manufacturer's safe operating pressure for air hoses, pipes, filters, or valves and other fittings. Remove defective hoses from service.

(5) To avoid tripping hazards, do not lay hoses over ladders, steps, scaffolds, or walkways.

(6) Do not use compressed air to blow dirt from the hands face or clothing.

(7) Do not use compressed air for cleaning purposes unless the outlet pressure is regulated to less than 30 psi (206.8 kPa) and then only when effective chip guarding and PPE (for example, face shield and safety glasses) are in place. This 30 psi (206.8 kPa) requirement does not apply to concrete form, mill scale, and similar cleaning purposes.

(8) When used with tools and equipment such as track drills, all airlines exceeding one-half ($\frac{1}{2}$) inch (1.3 cm) inside diameter must have a safety device at the source of supply or branch line to reduce pressure in case of hose failure.

(9) Governors.

(a) Install a speed governor, independent of the unloaders, on all air compressors, except those driven by electrical induction or electrical synchronized motors.

(b) If the air compressor is engine or turbine driven, install an auxiliary control to the governor to prevent racing when the unloader operates.

(10) Every air compressor must automatically stop its air compression operation before the discharge pressure exceeds the maximum working pressure allowable on the weakest portion of the system.

(a) If this automatic mechanism is electrically operated, the actuating device must be designed and constructed so that the electrical contact or contacts cannot lock or fuse in a position that will cause the compressor to continue its operation.

(b) An air bypass and alarm may be used as an alternative.

(11) Make provisions to exclude flammable materials and toxic gases, vapors, or dusts from the compressor and compressor intake and to prevent steam, water, or waste being blown or drawn into a compressor intake.

(12) Do not install valves in the air intake pipe to an air compressor with an atmospheric intake.

(13) The air discharge piping from the compressor to the air receiver must be at least as large as the discharge opening on the air compressor.

(14) Install a stop valve between the air receiver and each piece of stationary utilization equipment at a point convenient to the operator. Additionally, install a stop valve at each outlet to which an air hose may be attached.

(15) If a stop valve is located between the compressor and the receiver, install spring-loaded safety valves between the air compressor and the stop valve.

(a) Safety valves must be capable of limiting pressure in the air discharge piping to 10% above the working pressure of the piping.

(b) Stop valves should be the gate type. If a globe valve is used, it must be installed so that the pressure is under the seat and that the valve will not trap condensation.

(16) Make provisions in compressed air and gas systems for expansion and contraction and to counteract pulsation and vibration.

(17) Equip piping with traps or other means for removing liquid from the lines.

(18) Install air discharge piping to eliminate possible oil pockets.

(19) Installation and location of air receivers.

(a) Install air receivers so that all drains, hand holes, and manholes are accessible.

(b) Support air receivers with sufficient clearance to permit a complete external inspection and to avoid corrosion of external surfaces.

(c) Do not bury air receivers underground or locate them in inaccessible places.

(d) Locate the receiver to keep the discharge pipe as short as possible.

(e) Locate the receiver in a cool place to facilitate condensation of moisture and oil vapors.

(20) Install a drain valve at the lowest point of every air receiver for the removal of accumulated oil and water.

(21) Automatic traps may be installed in addition to drain valves.

(22) Open the drain valve on the air receiver and drain the receiver often enough to prevent the accumulation of excessive liquid in the receiver.

(23) Do not change tools or repair work until the stop valve in the air line supplying the equipment is closed.

(24) Use soapy water or any suitable non-toxic, non-flammable solution to clean the system.

(25) Use hose and hose connections used for connecting compressed air to utilization equipment that are designed for the pressure and service to which they are subjected according to the manufacturer's instructions.

c. Boilers and Systems. (20-8.c)

(1) Construct, operate, maintain, and inspect steam boilers and pressure vessels according to the ASME BPVC.

(2) When any boiler is being placed in service or restored to service after repairs to control circuits or safety devices are made, an operator must be in constant attendance until controls have successfully functioned through several cycles or for a 24-hour period, whichever is greater. The operator must read and record all indicating instruments at half-hour intervals to include time, date, and duration of test; water pressure at boiler; boiler make, type, and serial number; design pressure and rated capacity; gas pressure at burner; flue gas temperature at boiler outlet; and the surface temperature of the boiler jacket. Provide the completed record to the USACE supervisor/KO or COR.

(3) Provide fusible plugs on all boilers except water tube type.

(a) Replacement of fusible plugs must coincide with the inspections recommended by the ASME BPVC.

(b) When it is necessary to replace fusible plugs between inspections, prepare and forward to the responsible boiler inspector a written report that includes the circumstances, the make, part number, and the temperature rating for each of the plugs removed and replaced.

(4) Equip all boilers with water columns, gauge glass, and try cocks approved by a NRTL.

(a) Guard gauge glasses and water columns.

(b) When shutoffs are used on the connections to a water column, they must be of an approved locking or sealing type. See NBBI NBIC code for definition of an approved type.

(5) Equip all boilers with blowoff cocks or valves approved by a NRTL. Arrange the blowoff line so that leakage can be observed by the operator.

d. Compressed Gas Cylinders. (20-8.d)

(1) All Government-owned cylinders must be color-coded, and the gas contained identified by name according to MIL-STD 101B.

(2) Storage. Any cylinder in which gas will not be drawn from the cylinder within 24 hours must be stored according to the following:

(a) Store cylinders in well-ventilated locations.

(b) Store cylinders containing the same gas in a segregated group. Label empty cylinders as "EMPTY" and store in the same manner.

(c) Separate stored cylinders from flammable or combustible liquids and from easily ignitable materials (for example, wood, paper, packaging materials, oil, grease) by at least 40 feet (12.2 m) or by a fire-resistive partition having at least a 1-hour rating.

(d) Separate cylinders containing oxygen or oxidizing gases from cylinders in storage containing fuel gases by at least 20 feet (6.1 m) or by a fire-resistive partition having at least a 1-hour rating.

(e) Areas containing hazardous gas in storage must be appropriately placarded according to CGA P-1.

Note. Exception. If it is reasonably anticipated that gas will be drawn from a cylinder within 24 hours of initial storage, then it is considered “in-service” and these storage requirements do not apply.

(3) Smoking is prohibited wherever cylinders are stored, handled, or used. Separate all sources of ignition, including smoking, at least 50 feet (15.2 m) from areas where cylinders are stored, handled, or used. Conspicuously post with legible signs stating, “NO SMOKING, MATCHES, or OPEN FLAME.” (See chapter 9)

(4) Protect cylinders from physical damage, electric current, and extremes of temperature. Cylinder temperature must not exceed 125°F (51.7°C).

(5) Do not take cylinders containing oxygen and acetylene (or other fuel gas) into confined spaces.

(6) Cylinder Valves and Valve Caps.

(a) Close cylinder valves when cylinders are in storage, in transit, not in use, or empty.

(b) Cylinder valve caps must be in place when cylinders are in storage or transit, or whenever the regulator is not in place.

(c) Cylinder valves must be accessible while cylinders are in use to allow for shut off in an emergency situation.

(7) Secure all in-service compressed gas cylinders within substantial fixed or portable racks or hand trucks.

(8) Secure compressed gas cylinders in an upright position at all times, except when being hoisted. Do not store or transport acetylene cylinders horizontally.

(9) Compressed gas cylinders transported by crane, hoist, or derrick must be securely transported in cradles, nets, or skip pans and never directly by slings, chains, or magnets, unless the cylinder manufacturer’s handling instructions specifically allows other handling methods.

(10) Valve wrench or wheel must be in operating position when cylinder is in use.

(a) Open valves slowly.

(b) Do not open quick closing valves on fuel gas cylinders more than 1-1/2 turns.

(11) Use cylinders only for their designed purpose of containing a specific compressed gas.

(12) Only QPs may refill cylinders.

(13) Handle cylinders in a manner that will not weaken or damage the cylinder or valve.

(14) If a cylinder is leaking and can be safely moved, transport it to an isolated location out of doors and crack the valve to allow the gas to slowly escape.

(a) Keep personnel and all sources of ignition at least 100 feet (30.5 m) away from leaking cylinders.

(b) Use monitors to assure protection of personnel from health and flammability hazards.

(c) After the gas has escaped, tag the cylinder "DEFECTIVE."

(15) Do not simultaneously bleed cylinders containing different gases while in close proximity to each other.

(16) A QP must supervise the bleeding of cylinders containing toxic gases. Perform the work according to applicable environmental regulations and the accepted safety plans (for example, APP, AHA).

(17) Keep oxygen cylinders and fittings away from oil or grease.

(a) Keep cylinders, cylinder valves, couplings, regulators, hose, and other apparatus free from oil or greasy substance and do not handle with oily hands or gloves.

(b) Do not direct oxygen at oily surfaces, greasy cloths, or within a fuel oil or other storage tank or vessel.

(18) Oxygen and fuel gas pressure regulators, including their related gauges, must be in proper working order while in use.

e. Testing Using Pressurized Gases or Air. (20-8.e)

(1) Do not use pressurized gases or air during structural integrity or leak testing, except when permitted by the applicable manufacturer's specifications or when specified by an applicable code.

(2) Comply with the applicable codes and manufacturer's specifications when conducting tests that involve pressurized air or gases. A CP must develop the test procedures and submit them to the USACE supervisor for approval or to the KO or COR for acceptance. The CP is responsible for supervising the testing procedures. All workers performing the testing must be knowledgeable of the procedures, hazards, and

controls. Quality assurance and control measures must require strict enforcement of all requirements.

(3) If interim or final acceptance testing is anticipated to occur two or more months after the initial pipe or system installation preparatory meeting, conduct a supplemental preparatory meeting prior to the testing to review the test procedures and AHA.

20-9. Figures and Tables.

Not Applicable.

20-10. Checklists and Forms.

Not Applicable.

Chapter 21 Fall Protection

21-1. References.

- a. ANSI/ASSP A10.11, Safety Requirements for Personnel Nets (<https://www.assp.org>) (21-1.a)
- b. ANSI/ASSP A10.32, Personal Fall Protection Used in Construction and Demolition Operations (<https://www.assp.org>) (21-1.b)
- c. ANSI/ASSP Z359.0, Definitions and Nomenclature Used for Fall Protection and Fall Arrest (<https://www.assp.org>) (21-1.c)
- d. ANSI/ASSP Z359.1, The Fall Protection Code (<https://www.assp.org>) (21-1.d)
- e. ANSI/ASSP Z359.2, Minimum Requirements for a Comprehensive Managed Fall Protection Program (<https://www.assp.org>) (21-1.e)
- f. ANSI/ASSP Z359.3, Safety Requirements for Lanyards and Positioning Lanyards (<https://www.assp.org>) (21-1.f)
- g. ANSI/ASSP Z359.4, Safety Requirements for Assisted-Rescue and Self-Rescue Systems, Subsystems and Components (<https://www.assp.org>) (21-1.g)
- h. ANSI/ASSP Z359.6, Specifications and Design Requirements for Active Fall Protection Systems (<https://www.assp.org>) (21-1.h)
- i. ANSI/ASSP Z359.7, Qualification and Verification Testing of Fall Protection Products (<https://www.assp.org>) (21-1.i)

- j. ANSI/ASSP Z359.9-2021, Personal Equipment for Protection Against Falls – Descent Controllers (<https://www.assp.org>) (21-1.j)
- k. ANSI/ASSP Z359.11, Safety Requirements for Full Body Harnesses (<https://www.assp.org>) (21-1.k)
- l. ANSI/ASSP Z359.12, Connecting Components for Personal Fall Arrest Systems (<https://www.assp.org>) (21-1.l)
- m. ANSI/ASSP Z359.13, Personal Energy Absorbers and Energy Absorbing Lanyards (<https://www.assp.org>) (21-1.m)
- n. ANSI/ASSP Z359.14, Safety Requirements for Self-Retracting Devices for Personal Fall Arrest and Rescue Systems (<https://www.assp.org>) (21-1.n)
- o. ANSI/ASSP Z359.15, Safety Requirements for Single Anchor Lifelines and Fall Arresters for Personal Fall Arrest Systems (<https://www.assp.org>) (21-1.o)
- p. ANSI/ASSP Z359.16, Safety Requirements for Climbing Ladder Fall Arrest Systems (<https://www.assp.org>) (21-1.p)
- q. ANSI/ASSP Z359.18, Safety Requirements for Anchorage Connectors for Active Fall Protection Systems (<https://www.assp.org>) (21-1.q)
- r. ANSI/ASSP Z490.1, Criteria for Accepted Practices in Safety, Health and Environmental Training (<https://webstore.ansi.org/>) (21-1.r)
- s. ANSI/Scaffold and Access Industry Association (SAIA) A92.2, Vehicle-Mounted Elevating and Rotating Aerial Devices (<https://webstore.ansi.org/>) (21-1.s)
- t. ANSI/SAIA A92.3, Manually Propelled Elevating Aerial Platforms (<https://webstore.ansi.org/>) (21-1.t)
- u. ANSI/SAIA A92.5, Boom-Supported Elevating Work Platforms (<https://webstore.ansi.org/>) (21-1.u)
- v. ANSI/SAIA A92.6, Self-Propelled Elevating Work Platforms (<https://webstore.ansi.org/>) (21-1.v)
- w. 29 CFR 1910 Subpart D, Walking-Working Surfaces (<https://www.govinfo.gov/content/pkg/CFR-2022-title29-vol5/pdf/CFR-2022-title29-vol5-part1910-subpartD.pdf>) (21-1.w)
- x. 29 CFR 1910 Subpart I, Personal Protective Equipment (<https://www.govinfo.gov/content/pkg/CFR-2020-title29-vol5/pdf/CFR-2020-title29-vol5-part1910-subpartI.pdf>) (21-1.x)

y. 29 CFR 1926.106, Working Over or Near Water (<https://www.govinfo.gov/content/pkg/CFR-2020-title29-vol8/pdf/CFR-2020-title29-vol8-sec1926-106.pdf>) (21-1.y)

z. 29 CFR 1926.453, Aerial Lifts (<https://www.govinfo.gov/content/pkg/CFR-2022-title29-vol8/pdf/CFR-2022-title29-vol8-sec1926-453.pdf>) (21-1.z)

aa. 29 CFR 1926.1431, Hoisting Personnel (<https://www.govinfo.gov/content/pkg/CFR-2020-title29-vol8/pdf/CFR-2020-title29-vol8-sec1926-1431.pdf>) (21-1.aa)

bb. 29 CFR 1926 Subpart M, Fall Protection (<https://www.govinfo.gov/content/pkg/CFR-2020-title29-vol8/pdf/CFR-2020-title29-vol8-part1926-subpartM.pdf>) (21-1.bb)

21-2. Definitions.

a. Active Fall Protection System. A personal fall protection system that requires Authorized Persons (that is, End-Users) to wear or use personal fall protection equipment and that requires fall protection training. Active fall protection systems can include any travel restraint or personal fall arrest systems (PFAS). (21-2.a)

b. Anchorage. A secure connecting point or terminating component of a personal fall protection system that can safely withstand the forces exerted by the activation of fall protection and rescue equipment. The anchorage is a secured structure (for example, beam, girder, column, floor). Anchorage is either engineered or improvised. (21-2.b)

c. Anchorage Connector. A component or subsystem by which fall protection or rescue equipment is secured or attached to the anchorage. This includes any device designed to suspend human loads and capable of withstanding forces generated by a fall (for example, steel cable sling, tie-off adapter (that is, anchor strap), load-rated hoist ring designed for construction applications, tripod, davit arm). (21-2.c)

d. Authorized Person (End-User). A person who has been trained in the use of assigned personal fall protection equipment, including hands-on training and practical demonstrations in a typical fall-hazard situation. They use personal fall arrest, restraint, or positioning equipment while performing work assignments at heights. (21-2.d)

e. Authorized Rescuer. A person who is trained on rescue procedures and assigned by the employer to rescue Authorized Persons who may require rescue. (21-2.e)

f. Carrier. The specified track of a climbing ladder PFAS consisting of a flexible or rigid member upon which the carrier sleeve travels. The carrier is secured to the

climbing ladder or structure by carrier mounting brackets. The carrier may be continuous or may contain joints or splices. (21-2.f)

g. Certified Anchorage. An anchorage for personal fall arrest, positioning, restraint, or rescue systems that a QP for Fall Protection certifies to be capable of supporting the potential fall forces that could be encountered during a fall or that meet the criteria for a certified anchorage. (21-2.g)

h. Clearance Requirement. The distance below the Authorized Person that must remain clear of obstructions to ensure that the Authorized Person does not encounter any object or obstruction during a fall. (21-2.h)

i. Competent Person for Fall Protection (CP for Fall Protection). A person designated in writing by the employer to be responsible for the immediate supervision, implementation, and monitoring of the Fall Protection Program. The CP for Fall Protection, who through training, knowledge, and experience in fall protection and rescue systems and equipment, is capable of identifying, evaluating, and addressing existing and potential fall hazards. The CP for Fall Protection has the authority to take prompt corrective measures with regard to such hazards. The term “Competent Person (CP)”, as used in this chapter, refers to “Competent Person for Fall Protection.” (21-2.i)

j. Competent Person (CP) or Qualified Person (QP) Trainer. An individual who by training, knowledge, and experience can conduct CP or QP-level fall protection training (respectively). (21-2.j)

k. Competent Rescuer. An individual, who by training, knowledge, and experience in the safe use of specialized rescue equipment (for example, harness, lanyards, horizontal lifelines (HLL)), is capable of the implementation, supervision, and monitoring of the employer’s rescue plan. The individual in this role must be designated by the employer. (21-2.k)

l. Competent Rescuer Trainer. An individual who by training, knowledge, and experience specific to fall protection rescue, can conduct rescue training. (21-2.l)

m. Fall Protection Program Administrator (also known as, Program Manager). A person designated by the employer to be responsible for the development, implementation, monitoring, and evaluation of the employer’s Fall Protection Program. The Program Administrator must have training and a working knowledge of current fall protection regulations, standards, equipment, and systems. (21-2.m)

n. Free-Fall Distance. The vertical distance traveled during a fall, measured from the onset of a fall from a walking-working surface to the point at which the fall protection system begins to arrest the fall. It excludes deceleration distance and the elongation of a lifeline or lanyard. It includes any distance that a deceleration device slides before engaging or the distance that a self-retracting lifeline or lanyard extends before fall

arrest forces are applied. The distance is measured using a common reference point, typically the fall arrest attachment point (that is, anchor point). (21-2.n)

o. Horizontal Lifeline (HLL) System. An active fall protection system made of flexible wire, rope, or synthetic cable that is spanned horizontally between two end anchorages or anchorage connectors. It may include in-line energy absorber, lifeline tensioner, or turnbuckles and may also include intermediate anchorages. The system is used for attaching a fall arrest or in restraint system applications. (21-2.o)

p. Infrequent. A task or job is performed only on occasion, when needed (for example, equipment breakdown), on an occasional basis, or at sporadic or irregular intervals. Infrequent tasks include work activities such as annual maintenance or servicing of equipment, monthly or quarterly replacement of batteries or HVAC filters, and responding to equipment outage or breakdown. In these instances, the frequency of exposure to fall hazards is very limited. By contrast, tasks performed or repeated on a daily, routine, or regular basis are not infrequent activities. Infrequent tasks also do not include those that workers perform as a primary or routine part of their job or repeatedly at various locations during a work-shift. A task may be considered infrequent when it is performed once a month, once a year, or when needed. (21-2.p)

q. Lower Levels. Areas below the level where the employee is located and to which an employee can fall. Such areas include but are not limited to, ground levels, floors, roofs, ramps, runways, excavations, pits, tanks, materials, water, and equipment. (21-2.q)

r. Non-Certified Anchorage. Unquestionably strong anchorage that a CP can judge to be capable of supporting the predetermined anchorage strength as prescribed by 29 CFR 1926, Subpart M and ANSI/ASSP Z359.1 requirements. Non-certified anchorages are used for fall-arrest, work positioning, travel restraint, or rescue. (21-2.r)

s. Passive Fall Protection System. A system that does not require a worker to use or wear personal fall protection equipment. Examples include guardrails, safety nets, covers, and compliant parapet walls. (21-2.s)

t. Qualified Person for Fall Protection (QP for Fall Protection). A person with a recognized degree or professional certificate with extensive knowledge, training, and experience in the fall protection and rescue field. The QP for Fall Protection must be capable of designing, analyzing, evaluating, and specifying fall protection and rescue systems. The term “Qualified Person (QP),” as used in this chapter, refers to “Qualified Person for Fall Protection.” (21-2.t)

u. Single Anchor lifeline. A flexible line along which a fall arrestor travels that is supported by a single anchorage. A lifeline may be used in vertical, horizontal, or sloped applications. (21-2.u)

v. Temporary. Means that the duration of the task the worker performs is brief or short. Temporary, brief, or short tasks generally include those that a worker is able to perform in less time than it takes to install or set up conventional fall protection. Examples of temporary tasks include changing a filter in a roof-top HVAC system, replacing a part on a satellite dish, caulking or resealing the flashing around a skylight, or sweeping a chimney. (21-2.v)

21-3. Personnel Required Qualification/Training. Train all personnel (for example, Program Administrator, QPs, CPs, Authorized Persons, Authorized and Competent Rescuers, trainers) according to ANSI/ASSP Z359.2 and ANSI/ASSP Z490.1.

a. Fall Protection Program Administrator/Manager. (21-3.a)

(1) Training must be conducted by a CP trainer or QP trainer.

(2) USACE Program Administrators must complete annual refresher training consisting of at least one hour of fall protection and rescue-related informational meetings or training.

b. Qualified Person for Fall Protection (QP for Fall Protection). (21-3.b)

(1) Training must be conducted according to ANSI Z359.2 and be conducted by a QP trainer.

(2) Training must include instruction in proper identification, design, assembly, inspection, certification, recertification, and use of all fall protection equipment and systems that they encounter in their work as a QP.

(3) Training must be conducted according to ANSI Z359.2.

(4) USACE QPs must complete annual refresher training consisting of at least one hour of fall protection and rescue-related informational meetings or trainings.

c. Competent Person for Fall Protection (CP for Fall Protection). (21-3.c)

(1) Training must be conducted by a CP trainer or QP trainer.

(2) Initial training must include a minimum of 24 hours of course work, with a combination of formal classroom training and performance assessment of trainees based upon observation of physical demonstrations of skill or theoretical exercises. The CP trainer must document the training and issue a single certificate to the CP that shows that they have completed CP fall protection training.

(3) USACE CPs must complete annual refresher training consisting of at least two hours of fall protection and rescue-related informational meetings or trainings.

(4) CPs must have the authority to stop work if it is determined to be unsafe.

d. Authorized Person (End-User). (21-3.d)

(1) Training must be conducted, at minimum, by a CP that is qualified to train on the safe use and hazards of fall protection systems and equipment. Authorized Persons must be trained before they use the personal fall protection equipment. The CP must be qualified to train workers to safely use fall protection systems and equipment and to recognize fall hazards related to their use.

(2) The training must include:

(a) The nature of fall hazards in the work area.

(b) The correct procedures for erecting, using, dismantling, inspecting, maintaining, and storing fall protection equipment.

(c) The application limits, free-fall distance, total fall distance, and clearance requirements of fall protection systems and equipment.

(d) Rescue equipment and procedures.

(e) Hands-on training and practical demonstrations.

(f) Proper anchoring and tie off techniques.

(g) All applicable requirements from this chapter.

(3) Retrain Authorized Persons as necessary when any of the following situations present):

(a) There are changes in the Fall Protection Program that make earlier training obsolete.

(b) There are changes in fall protection or rescue equipment that make earlier training obsolete.

(c) Inadequacies in an employee's performance are identified that indicate a lack of knowledge or skill.

(d) There are changes in workplace conditions that could affect the safe use of the personal fall protection equipment.

(4) In addition to any of the above retraining situations, Authorized Persons must complete annual refresher training consisting of at least one hour of training that includes a refresher and any changes to the fall protection and rescue requirements.

e. Competent Rescuer. (21-3.e)

(1) Training must be conducted, at minimum, by a Competent Rescue trainer.

(2) Competent Rescuers must have a working knowledge, through experience and training, of current fall protection and planned rescue standards, equipment, and systems.

(3) The training must include:

(a) Safe use of all types of equipment and systems used for rescue including inspection of the systems prior to use, installation, component compatibility, descent control, backup systems, dismantling, storage, and the common hazards associated with each system.

(b) Instruction and practical demonstrations (that is, performance assessment) on how to properly select, inspect, anchor, assemble and use the fall protection and rescue equipment used.

(4) Competent Rescuers must complete refresher training every two years, with rescue drills conducted annually, to stay current with fall protection and rescue requirements.

f. Authorized Rescuer. (21-3.f)

(1) Training must be conducted, at minimum, by a Competent Rescuer. Authorized Rescuers must be trained before they are exposed to fall hazards or a potential rescue event.

(2) Training must include:

(a) Instruction in the method(s) of rescue and equipment being used including self-rescue and assisted rescue.

(b) Practical demonstrations on the fall protection and rescue equipment the individual may use. The demonstration must include how to properly select, inspect, anchor, assemble, disassemble, store, and use the equipment u.

(c) A demonstration (that is, performance assessment) by the trainee on before-use inspection of rescue equipment and systems.

(3) Authorized Rescuers must complete refresher training every two years, with rescue drills conducted annually, to stay current with fall protection and rescue requirements.

21-4. Roles and Responsibilities.

a. Fall Protection Program Administrator. The Program Administrator is responsible for the overall development, implementation, monitoring and evaluation of the employer's Fall Protection Program. This person can also function as a QP, CP, CP trainer, QP trainer or competent rescue trainer if so trained (see para 21-3). The Program Administrator will: (21-4.a)

(1) Advise and provide guidance for managers, employees, and others on all matters pertaining to their Fall Protection Program.

(2) Establish all duties and responsibilities required by the Fall Protection Program and assign them to individuals who are trained and qualified to perform them.

(3) Verify personnel are provided with resources to accomplish their responsibilities.

(4) Establish and implement a procedure to identify and eliminate or control new and existing fall hazards.

(5) Ensure the proper development and implementation of the Fall Protection and Prevention Plan and Rescue Plan (see para 21-7).

(6) Ensure that an appropriate level of training is provided to all personnel involved in the Fall Protection Program, to include Authorized Persons, CPs, QPs, and others as required.

(7) Ensure that a rescue plan is prepared and implemented for every location where a PFAS is used to control fall hazards.

(8) Participate in investigations, either personally or by designating persons qualified to perform the investigation, of all accidents and near misses related to falls from heights.

(9) Measure and evaluate the effectiveness of the Fall Protection Program by conducting periodic program evaluations. Make necessary improvements.

b. Qualified Person for Fall Protection (QP for Fall Protection). The QP is responsible for technical support of the Fall Protection Program. The QP will: (21-4.b)

(1) Design, analyze, evaluate, and specify fall protection and rescue systems.

(2) Supervise the design, selection, installation, and inspection of certified anchorages and HLL.

(3) Participate in investigation of all accidents and near misses related to falls from heights.

c. CP for Fall protection. The CP is responsible for the onsite supervision, implementation, and monitoring of the Fall Protection Program. The CP will: (21-4.c)

(1) Conduct a fall hazard survey to identify all fall hazards before End-Users are exposed to those hazards.

(2) Identify, evaluate, and impose limits on the workplace activities to control fall hazard exposures and swing falls and communicate all limitations to all employees authorized to utilize the fall protection system.

(3) Immediately stop the work if it is determined to be unsafe and take prompt corrective measures to mitigate fall hazards.

(4) Prepare, update, review, and approve Fall Protection and Prevention Plans as directed by the Program Administrator. Specify in the Fall Protection and Prevention Plan, the fall protection systems, anchorage locations, connecting means, body harness, and other equipment that Authorized Persons must use when exposed to a fall hazard. (See para 21-7)

(5) Review procedures as workplace activities change to determine if additional practices, procedures, or training need to be implemented before workplace activities continue.

(6) Ensure that a Rescue Plan has been developed and is in place for all PFAS (see para 21-7).

(7) Supervise the selection, installation, use, and inspection of non-certified anchorages in consultation with the Fall Protection Program Manager and QP.

(8) Verify that personal fall protection systems are properly installed and inspected.

(9) Prior to working at heights, verify Authorized Persons are trained and authorized to do so.

(10) Prior to working at heights, verify that available and required clearances are adequate before Authorized Persons start work (see table 21-1).

(11) Review at least annually and as needed, the Fall Protection and Prevention Plan and the Rescue Plan to ensure the Authorized Persons are up to date with and practicing the latest procedures for each workplace.

(12) Ensure prompt rescue of Authorized Persons can be accomplished via the procedures identified in the Rescue Plan.

(13) Participate in investigations of all accidents and near misses related to falls from heights.

(14) Immediately remove from service all personal fall protection systems and equipment that is damaged, malfunctioning, or was subjected to a fall.

(15) Inspect and document all fall protection equipment at frequency required by manufacturer, applicable regulations, and this chapter (see para 21-5).

d. Authorized Person. The Authorized Person must understand workplace activities and fall protection, rescue systems, and equipment used. They must follow the policy, procedures, and the instructions of the CP. The Authorized Person will: (21-4.d)

(1) Bring to the attention of the CP all unsafe or hazardous conditions, actions, or unsafe work practices that may cause injury either to themselves or others, before proceeding with the workplace activities.

(2) Properly use, inspect, maintain, store, and care for their fall protection equipment and systems.

(3) Inspect all fall protection equipment for damage or defects prior to each use and notify the CP of any concerns prior to using (see para 21-5).

e. Competent Rescuer. The Competent Rescuer is responsible for anticipating the potential for rescue and implementing, supervising, and monitoring the Rescue Plan before Authorized Persons start any work at heights (see para 21-7). In addition, the Competent Rescuer will: (21-4.e)

(1) Verify all Authorized Rescuers have been trained and are proficient at performing rescue procedures.

(2) Identify and confirm the availability of the resources necessary to conduct a safe, effective, and prompt rescue from heights

(3) Know the hazards associated with rescue from heights and how to mitigate these hazards within the rescue area.

(4) Verify the rescue equipment is protected against damage by workplace conditions.

(5) Verify Rescue Plans, procedures, and methods are effective by conducting rescue drills at least annually. Ensure that any deficiencies are corrected. (See para 21-7.b)

f. Authorized Rescuer. The Authorized Rescuers is responsible for performing or assisting in workplace rescues for personnel suspended in or attached to fall protection systems. The Authorized Rescuer will: (21-4.f)

(1) Verify that a Rescue Plan and procedures have been developed for any workplace where a PFAS is used. Review the plan and procedures before fall hazards are encountered in the workplace.

(2) Inspect the rescue equipment intended for use in a rescue according to procedures developed by the Competent Rescuer. Ensure that it is protected, in proper working condition, and securely stored until it is needed.

(3) Recognize fall hazards that may endanger the rescuer during rescue operations. Including the necessary procedures in the Rescue Plan to ensure the rescuer safety.

g. Employer. The employer will ensure adequate resources (for example, equipment, training, personnel) are provided to ensure prompt rescue to all fallen workers. (21-4.g)

21-5. Inspection Requirements.

a. Fall Protection Equipment. Inspect fall protection and rescue systems and equipment according to the manufacturer's instructions and any other applicable requirements, or as prescribed by the CP, to include the following: (21-5.a)

(1) Remove from service any equipment that is damaged, malfunctioning, or was subjected to a fall.

(2) Before Use. The Authorized Person and Authorized Rescuer must inspect personal fall protection and rescue equipment prior to each use to determine that it is in a safe working condition.

(3) Semi-Annual. A CP must inspect fall protection and rescue systems and equipment at least semi-annually and whenever equipment is subjected to a fall. Such inspections must be documented by the CP.

(4) Inspect, at minimum, the following:

(a) Harnesses, Lanyards, Straps, and Ropes. Check all components for cuts, wear, tears, damaged threads, broken fibers, undo stretching, pulled or torn stitches, frayed edges, mold, alterations, damage due to deteriorations, discoloration, abrasions,

burn or chemical damage (for example, contact with fire, acids, corrosives), UV deterioration, missing markings or labels, and any internal deterioration.

(b) Hardware (for example, snaphooks, carabiners, connectors, D-rings). Check all components for signs of excessive wear, cracks, corrosion, and deformation. Look for distorted hooks or faulty springs, tongues unfitted to the shoulder buckles, lose or damaged mountings, and non-functional parts.

b. Safety Nets. CPs must inspect safety nets according to the manufacturer's instructions and ANSI/ASSP A10.11 and 29 CFR 1926.502 (29 CFR 1926 Subpart M). Remove from service and replace any damaged or defective nets. Such inspections must be documented by the CP. (21-5.b)

21-6. Activity Hazard Analysis (AHA) Requirements.

Develop AHAs according to paragraphs 1-6 or 2-6, as applicable, to include the following:

a. Prior to erecting or dismantling scaffolds, a CP must conduct an evaluation to determine the feasibility and safety of providing fall protection. If fall protection is not feasible, detail the rationale for infeasibility and what fall hazard controls will be used in the AHA. (21-6.a)

b. It is understood that the provision of fall protection for the first person who establishes anchorages may be difficult because this first person is the source of the initial anchorage. In this situation, fall protection may not be required. This decision will be made by the CP and documented in the AHA for the task. After anchorages are installed, fall protection is required. (21-6.b)

21-7. Minimum Plan Requirements.

a. Fall Protection and Prevention Plan. A Fall Protection and Prevention Plan is required when employees are working at heights or exposed to fall hazards. The plan must be developed by a CP or QP and updated as conditions change, but at least annually. The plan must include the following: (21-7.a)

(1) Detailed description of the activity being performed.

(2) Description of the anticipated hazards or concerns and the control measures that will be implemented to mitigate the hazards to an acceptable level. Describe the fall protection and prevention systems, to include the design of anchorages and fall arrest and HLL systems and the equipment and methods employed for the phase of work.

(3) Assignment of personnel and their roles and responsibilities. Include necessary information/documentation to support qualification/training of such persons according to para 21-3). If fall protection components or systems are used that require

instructions, supervision, design calculations, or drawings, then include the name, qualifications, and responsibilities of the QP.

(4) Inspection and oversight methods to ensure adherence to the plan.

(5) Describe maintenance and storage of fall protection equipment.

b. Rescue Plan. A Rescue Plan (that is, written rescue procedures) is required when PFAS are used. The plan must be developed by a Competent Rescuer to include the following: (21-7.b)

(1) Method(s) for self-rescue and assisted rescue of any worker who falls including rescue equipment. The rescue function may be performed by self-rescue, assisted rescue, local emergency services, in-house professionals, CPs, QPs or contractor services.

Note. If other methods of rescue are planned (that is, jurisdictional public or government emergency rescue agencies), indicate in the plan how to contact and summon the agency to the site.

(2) If required, identify, select, and document anchorages for self-rescue and assisted rescue. Anchorages selected for rescue must be capable of withstanding static loads of 3,000 pounds (13.3 kN) or five times the applied loads as designed by a QP.

(3) Rescue equipment used for self-rescue or assisted rescue (that is, self-retracting lanyard (SRL) with rescue capability) must meet ANSI/ASSP Z359.4 and Z359.14.

(4) Identify assigned safety spotters (also known as, the “buddy system”) who will be within visual and verbal range to initiate rescue of the fallen worker, if required.

c. Fall Protection Program (USACE Only). A written Fall Protection Program must be developed when USACE employees perform work at heights. The program must include the following: (21-7.c)

(1) Requirements for each facility to develop a Site-Specific Fall Protection and Prevention Plan and Rescue Plan (see paras 21-7.a and 21-7.b).

(2) Procedures for conducting fall hazard surveys and preparation of a survey report for all facilities.

21-8. General Requirements.

a. Fall Protection Threshold Height Requirements. Floating plant and vessels are excluded from these requirements, except where specifically cited in chapter 19. See chapter 25 for fall protection requirements in excavations. (21-8.a)

(1) Unless specified differently below, the fall protection threshold height requirement is 6 feet (1.8 m) for all work covered by this manual. This requirement applies to both government and contractor workers and includes steel erection activities, systems-engineered activities (for example, prefabricated), metal buildings, residential wood construction, scaffolding work, installing or removing sheet piles, cofferdams, h-piles, or other interlocking materials.

Note. Do not use sheet pile stirrups as a fall protection method.

(2) For all work performed on USACE-owned or operated permanent facilities, the threshold height requirement when working on or near open-sided floors, platforms, or unprotected edges is 4 feet (1.2 m).

(3) Workers exposed to fall hazards must be protected from falling to a lower level by the use of standard guardrails, work platforms, temporary floors, safety nets, engineered fall protection systems, personal fall protection systems, or the equivalent in the following situations:

(a) Where there is a possibility of a fall from any height onto dangerous equipment, into a hazardous environment, or onto an impalement, provide hazard fall protection, regardless of height.

(b) Whenever workers are exposed to falls from unprotected sides or edges, access ways, fixed ladders over 24 feet (7.3 m) in height, unprotected roof edge or floor openings, holes and skylights, unstable surfaces, leading edge work, scaffolds, formwork, work platforms, rebar assembly, steel erection, and engineered metal buildings.

(c) For access ways or work platforms over water, machinery, or dangerous operations.

(d) For steel erection activities, when connectors are working at the same connecting point, they must connect one end of the structural member before going out to connect the other end. The connectors must always be 100% tied off.

b. Fall Protection Control Measures. Use the following hierarchy of controls for fall protection to abate fall hazards. Select and use a fall protection method(s) to protect workers performing work at heights: (21-8.b)

(1) Elimination/Prevention. Remove the hazard from work areas or change the task, process, controls or use other means to eliminate the need to work at heights with its subsequent exposure to fall hazards. Use the most effective control method, such as build roof trusses on ground level and then lift into place or lower the location of a meter or valve at high locations to the worker's level.

(2) Passive Controls (same-level barrier). Isolate and separate fall hazards from work areas by erecting same-level barriers such as guardrails, walls, covers, or parapets.

(3) Active Controls (Personal Protective Systems and Equipment). Use of personal fall protection systems, including and in order of effectiveness: restraint, positioning, or PFAS. All systems require the use of full body harness, connecting means, and safe anchorage system.

(4) Administrative Controls. Introduce new work practices that reduce the risk of falling from heights, or to warn a person to avoid approaching a fall hazard (for example, warning systems, warning lines, audible alarms, signs, training of workers to recognize specific fall hazards).

c. Personal Fall Protection Equipment Systems and Sub Systems (Active Fall Protection Systems). All personal fall protection systems must meet the requirements contained in ANSI/ASSP Z359 standards. All newly purchased equipment will meet the latest ANSI/ASSP standards. Equipment manufactured to ANSI/ASSP Z359.1 prior to 2007 is not permitted on USACE project sites. (21-8.c)

(1) Use personal fall protection equipment and systems whenever a person is working at heights and exposed to a fall hazard.

Note. It is understood that the provision of fall protection for the first person who establishes anchorages may be difficult because this first person is the source of the initial anchorage. In this situation, fall protection may not be required. This decision will be made by the CP and documented in the AHA for the task. After anchorages are installed, fall protection is required.

(2) Base the selection of personal fall protection equipment on the type of work being performed, the work environment, worker characteristics (for example, weight, size, shape), the type and position and the location of anchorage, and the required length and type of the connecting means needed to perform the work activity.

(3) Anchorage System (Anchorage PFAS).

(a) Anchorages used for attaching the PFAS must be independent of any anchorage used to support or suspend platforms. They must be capable of supporting at least 5,000 pounds (22.2 kN) per worker attached for non-certified anchorages or be

designed by a QP for twice the maximum arrest force on the body for certified anchorages.

Note. Do not use electric conduits, utility pipes, ductwork, or unstable points as anchorages for personal fall protection systems.

(b) Anchorage Connectors. Use anchorage connectors to attach the PFAS to the anchorage. When anchorage connectors are used to attach the PFAS to the anchorage, they must be capable of withstanding without breaking a 5,000 pounds (22.2 kN) load per attached worker. Do not attach more than one connecting means (that is, worker) to an anchorage connector, unless designed and designated by a QP or the manufacturer (for example, tripod or davit style anchorage connectors).

(4) Connecting Means.

(a) Connecting means and subsystems may include energy absorbing lanyards with snap hooks or carabiners at each end, self-retracting devices (SRDs), or fall arresters (for example, rope or cable grabs).

(b) Lanyards must be ropes, straps, or webbing made from synthetic materials or steel.

(c) Energy absorbing lanyards, including rip stitch, tearing, and deforming lanyards must be capable of sustaining a minimum tensile load of 5,000 pounds (22.2 kN).

(d) Single or “Y” lanyards used in PFAS must not be longer than 6 feet (1.8 m) in length.

(e) Use a 6 feet (1.8 m) free-fall energy-absorbing lanyard only when the tie-off point is located above the dorsal D-ring, creating a free-fall distance of less than 6 feet (1.8 m). When the energy absorber is deployed during a fall, the average arrest force on the body must not exceed 900 pounds (4 kN) under ambient dry conditions, with a maximum deceleration distance of 4 feet (1.2 m) and the maximum arresting force is 1,800 pounds (8 kN). (See ANSI/ASSP Z359.13)

(f) When an anchor point is located below the dorsal D-ring, a free-fall distance greater than 6 feet (1.8 m) is created. For these situations, use a 12 feet (3.7 m) free-fall energy absorbing lanyard according to the manufacturer’s instructions and recommendations. When the energy absorber is deployed during a fall, the average arrest force on the body must not exceed 1,350 pounds (6 kN), with a maximum deceleration distance of 5 feet (1.5 m) and the maximum arresting force is 1,800 pounds (8 kN). (See ANSI/ASSP Z359.13)

Note. A 12 feet (3.7 m) free-fall energy absorbing lanyard does not refer to the lanyard length. Instead, it refers to a free-fall distance that is greater than 6 feet (1.8 m) and up

to 12 feet (3.7 m) that is created by the anchor point being located below the dorsal D-ring. The maximum length of the lanyard used must not exceed 6 feet (1.8 m).

(g) The 6 feet (1.8 m) and 12 feet (3.7 m) free-fall energy absorbing lanyards must meet the requirements of ANSI/ASSP Z359.13.

(h) Do not loop lanyards over or through an object and then attached back to themselves, unless permitted by the manufacturer.

(i) “Y” Lanyards (that is, double leg). When using a lanyard with two integrally connected legs for 100% tie-off, attach only the snaphook, located at the center of the lanyard near the energy absorber, to the fall arrest attachment element of the harness.

(i-1) The two legs of the lanyard and the joint between the legs must withstand a force of 5,000 pounds (22.2 kN).

(i-2) When one leg of the lanyard is attached to the anchorage, do not attached the unused leg of the lanyard to any part of the harness except to attachment points specifically designated by the manufacturer for this purpose (for example, lanyard parking attachment element).

(i-3) The 6 feet (1.8 m) free-fall “Y” lanyard may only be used when the tie-off point is located above the dorsal D-ring height, creating a free-fall distance of less than 6 feet (1.8 m).

(i-4) When the tie-off point is located below the dorsal D-ring, the free-fall distance is greater than 6 feet (1.8 m), so a 12 feet (3.7 m) free-fall “Y” lanyard must be used.

Note. A 12 feet (3.7 m) free-fall energy absorbing “Y” lanyard does not refer to the lanyard length. Instead, it refers to a free-fall that is greater than 6 feet (1.8 m) up to 12 feet (3.7 m) which is created by the anchor point being located below the dorsal D-ring. The maximum length of each leg of the “Y” lanyard used must not exceed 6 feet (1.8 m)

(i-5) The maximum arrest force on the body must not exceed 1,800 pounds (8 kN).

(i-6) The 6 feet (1.8 m) and 12 feet (3.7 m) free-fall energy absorbing “Y” lanyards must meet ANSI/ASSP Z359.13 requirements.

(j) Equip all single and “Y” energy absorbing lanyards with at least one deployment indicator. Design personal energy absorbing lanyards such that it is obvious if they have been activated, or include a warning, flag or label that indicates activation.

(5) Self-Retracting Devices (SRDs). All SRDs must meet and be used according to the requirements of ANSI/ASSP Z359.14. Select the type and class most appropriate for the fall hazard and work activities performed.

(6) Fall Arresters. Fall arresters (that is, rope grabs) that are designed to be used with a single anchor lifeline or climbing ladder fall arrest systems (that is, ladder climbing devices) must be approved by the manufacturer for such use. Fall arresters must have a minimum ultimate strength of 3,600 pounds (16 kN).

(a) For single anchor lifelines climbing ladder fall arrest systems, use the automatic fall arresters.

(b) The requirements for fall arresters in ANSI/SSP Z359.15 supersede the corresponding requirements prescribed in ANSI/ASSP Z359.1.

(7) Hardware (Snap hooks, Carabiners, D-rings, and Connectors)

(a) Snaphooks and carabiners must be self-closing and self-locking, and capable of being opened only by at least two consecutive deliberate actions.

(b) Snaphooks and carabiners must have a minimum gate strength of 3,600 pounds (16 kN) in all directions (see ANSI/ASSP Z359.12).

(c) Snaphooks and carabiners must have a minimum tensile strength of 5,000 pounds (22.2 kN). D-rings, O-rings, snaphooks and carabiners must be capable of withstanding a tensile load of 5,000 pounds (22.2 kN).

(d) Connectors, adjusters, and any buckles used as adjusters must be capable of withstanding a minimum tensile load of 3,372 pounds (15 kN). They must be made of drop forged, pressed, or formed steel, or made of equivalent materials. They must have a corrosion resistant finish and all surfaces and edges must be smooth to prevent damage to interfacing parts of the system.

(e) All connecting components used in PFAS must be compatible and used properly.

Note. The requirements for hardware and connectors prescribed in ANSI/ASSP Z359.12 supersede the corresponding requirements prescribed in ANSI/ASSP Z359.1.

(8) Body Harnesses.

(a) Full Body Harness. PFAS require the use of a full-body harness. Do not use body belts.

(b) Only full body harnesses meeting the requirements of ANSI/ASSP Z359.1 or Z359.11 are permitted.

(c) All full body harnesses used in PFAS must permanently incorporate a dorsal attachment element (that is, D-ring), may contain any combination of other elements, and must permanently include a load bearing sub-pelvic strap. All full body harnesses must permanently incorporate a waist belt, back strap, or other means of controlling the separation of the shoulder straps on the back of the full body harness. The dorsal D-ring must be integrally attached and positioned at the wearer's upper back between the shoulder blades. The dorsal D-ring may also be used in travel restraint and rescue.

(d) Only use sternal attachment points when determined acceptable by the CP and where there is no chance to fall in a direction other than feet first and fall distance is no greater than 2 feet (0.6 m).

Note. The sternal attachment may also be used for ladder climbing with guided fall arrester, or ladder climbing with an overhead self-retracting lifeline, during fall arrest, work positioning, travel restraint, rescue, or rope access.

(e) The frontal D-ring is located at the waist for use as a ladder climbing connection for guided type fall arresters where there is no chance of a fall in a direction other than the feet first. The frontal D-ring is also used in suspended rope access system, work positioning, travel restraint and rescue.

(f) Equip all full body harnesses with suspension trauma preventers (for example, stirrups, relief steps) to provide short-term relief from the effects of suspension trauma.

(g) Equip all harnesses with at least one fall-arrest indicator and at least one lanyard parking attachment element having a disengagement load of not more than 120 pounds (0.5 kN). Use the lanyard parking attachment element to attach the unused leg of the "Y" lanyard to the harness.

(h) Lineman's Equipment (electrically rated harnesses). Body harnesses used around high voltage equipment or structures must be an industry designed "linemen's fall protection harness" that will resist arc flash, such body harnesses must meet the requirements of ASTM F887 and ANSI/ASSP Z359.11 and must bear a label or similar stating such. The arc flash harnesses must either have straps or plastic-coated D-rings and positioning side-rings in lieu of exposed metal D-rings and exposed metal positioning side-rings. All other exposed metal parts of the linemen's harnesses (for example, buckles and adjusters) must also be plastic coated. The harness may have no metal above the waist or, if there is, must be equipped with insulated metal components.

(9) Personal Fall Arrest Systems (PFAS).

(a) PFASs are generally certified for users within the capacity range of 130 to 310 lbs. (59 to 140.6 kg) and include the weight of the worker, equipment, and tools.

(b) Do not exceed the 310 lbs. (140.6 kg) limit unless permitted in writing by the manufacturer.

(c) For workers with body weight less than 130 lbs. (59 kg), use a specially designed harness and a specially designed energy absorbing lanyard that will properly deploy if they were to fall.

(d) When stopping a fall, the PFAS must limit the maximum arresting force on the body of the employee to 1,800 pounds (8.0 kN) when used with a full body harness.

(e) Rig PFAS such that a use can neither free-fall more than 6 feet (1.8 m) nor contact any lower level or other physical hazard in the path of the fall. The free-fall distance of 6 feet (1.8 m) can be exceeded if the proper energy absorbing lanyard is used and there is adequate clearance distance.

Note. Free-fall distances should always be kept to a minimum. PFAS must be rigged so an employee cannot free-fall in excess of 6 feet (1.8 m), provided the employer can demonstrate the manufacturer designed the system to allow a free-fall of more than 6 feet (1.8 m) and tested the system to ensure a maximum arresting force of 1,800 pounds (8 kN) is not exceeded.

(10) Flexible HLL.

(a) Do not use locally manufactured flexible HLLs unless they are custom designed for limited use or site-specific applications by an RPE who is also qualified in designing HLL systems. See paragraphs 1-2 or 2-2, as applicable, for RPE definition.

(b) Commercially manufactured HLLs must be designed, installed, certified, and used under the supervision of a QP, as part of a complete PFAS. The CP may, if deemed appropriate by and under the direction of the QP, supervise the assembly, disassembly, use, and inspection of the HLL systems.

(c) The design must include drawings, required clearance, instructions on proper installation and use procedures, proof testing reports, and inspection requirements.

(d) An RPE must design all HLL anchorages who is also trained and qualified in designing HLL systems (see ANSI/ASSP Z359.6).

(e) The design of all HLLs must be approved by the USACE supervisor or accepted by KO or COR as part of the Fall Protection and Prevention Plan.

(f) Do not use steel cable or wire rope guardrails as a HLL unless it meets the requirements of an HLL.

(11) Single Anchor Lifelines. A single anchor lifeline must have a minimum tensile strength of 5,000 pounds (22.2 kN) and may only be attached to a single overhead

anchorage. Each worker must be attached to a separate lifeline system. Single anchor lifelines can be used in horizontal, vertical, and sloped applications.

Note. The requirements for single anchor lifelines prescribed in ANSI/ASSP Z359.15 supersede the corresponding requirements prescribed in ANSI/ASSP Z359.1.

(12) Climbing Ladder Fall Arrest Systems (CLFAS). CLFAS include the carrier, carrier mounting brackets, and the carrier sleeve. The carrier is a track that is at least 20 feet (6.1 m) in length and consists of a rigid or flexible member that is securely attached to the climbing fixed ladder or to the adjacent structure. The carrier sleeve (cable grab) is connected to the harness and travels along the carrier during climbing.

(a) Anchorage strength must be a minimum of 3,000 pounds (13.3 kN) or 2,700 pounds (12 kN) according to ANSI Z359.16. The applied load transferred to the system because of a fall must be at least 2,700 pounds (12 kN).

(b) The carrier sleeve located between the front D-ring of the harness and the carrier must be 9 inches (23 cm) long.

Note. Effective two years from date of this publication, all carrier sleeves used must be equipped with panic grab.

(c) The free-fall distance when using a CLFAS must not exceed 2 feet (0.6 m).

(d) Ensure that there is 100% transition at the top of the CLFAS for safe access to above work surface or roof.

(e) Do not install CLFAS on ladders that have three-quarter ($\frac{3}{4}$) inch (1.9 cm) rungs (for example, commercial off-the-shelf ladders) unless the ladders are designed to withstand the fall forces.

(13) Restraint System.

(a) Consider using restraint system over fall arrest. Restraint is an active fall protection system that prevents the user from reaching an area where a free-fall could occur.

(b) Anchorages used for restraint systems must be capable of supporting at least 3,000 pounds (13.3 kN) per worker attached for non-certified anchorages or be designed by a QP for twice the maximum foreseeable force for certified anchorages.

(c) Use restraint systems only on flat or low-sloped surfaces ($\leq 18.4^\circ$ or 4:12 slope).

(d) Select and rig the connecting means to allow travel of the user only so far that they are not exposed to the fall hazard.

Note. When lanyards are used as the connecting means, the lanyard may be longer than 6 feet (1.8 m) and the length can either be adjustable or fixed.

(14) Positioning System. A positioning system uses some of the same equipment as an active fall protection system (for example, arrest, restraint). However, a positioning system used alone does not constitute fall protection and an additional fall protection system must be used in conjunction (for example, PFAS). The following are system requirements for positioning systems:

(a) They must be rigged such that a worker cannot free-fall more than 2 feet (0.6 m).

(b) Anchorages used for attached positioning systems must be capable of supporting at least 3,000 pounds (13.3 kN) per worker attached for non-certified anchorage or twice the potential impact load of a worker's fall for certified anchorage or, whichever is greater.

(c) Ensure that workers achieve 100% tie-off during use.

(d) Use attachment points for positioning on the full body according to the manufacturer's instructions (for example, sides or front of the harness).

(e) Positioning lanyard can be adjustable or fixed.

d. Guardrail Systems (Passive Fall Protection System). To be considered an effective fall protection system, guardrail systems must be installed to meet the requirements of paragraph 21-8.d. If deficiencies in the system are identified, the system must be corrected before personnel are exposed to the fall hazard(s), or another fall protection system must be implemented to provide the necessary protection from exposure to the fall hazard(s). A standard guardrail system must meet the following (see chapter 19 for marine and floating plant guardrails): (21-8.d)

(1) Toprails, midrails, and posts, and must have a vertical height of 42 +/- 3 inches (106.7 cm +/- 7.6 cm) from the upper surface of the toprail to the floor, platform, runway, or ramp level.

(2) Erect midrails halfway between the toprails and the floor, platform, runway, or ramp.

(3) The ends of the toprails and midrails must not overhang the terminal posts except where such overhang does not create a projection hazard.

(4) Provide toe-boards on all open sides and ends at locations where persons are required or permitted to pass or work under the elevated platform, or where needed to prevent persons and material from falling from the elevated platform.

(a) Toe-boards must be, at minimum, 3.5 inches (9 cm) in vertical height. Construct them from 1 inch x 4 inches (2.5 cm x 10.2 cm) lumber or the equivalent.

(b) Securely fasten toe-boards in place so there is no more than one-quarter ($\frac{1}{4}$) inch (0.6 cm) clearance above floor level.

(c) Construct toe-boards of any substantial material, either solid or with openings between adjacent pieces not greater than 1 inch (2.5 cm).

(d) Where material is piled to such a height that a standard toe-board does not provide protection, provide paneling or screening from floor to toprail or midrail.

(e) Toe-boards must support a force of at least 50 pounds (0.22 kN) applied in any outward or downward direction at any point along the toe-board.

(5) Posts. Space posts no more than 8 feet (2.4 m) apart. Install supporting posts at whatever distance is necessary to meet the top rail strength requirement of 200 pounds (0.89 kN) without failure. (See 29 CFR 1910, Subpart D)

(6) Guardrail systems must be smooth surfaced to prevent injury to a worker from punctures or lacerations and to prevent snagging of clothing.

(7) Do not use synthetic or natural fiber ropes as toprails or midrails.

(8) Commercial, off-the-shelf (COTS), engineered guardrail systems may be used instead of constructing a system. If a COTS system is installed, design and manufacture the portable guardrail system (for example, webbing, straps) to meet the same requirements in paragraph 21-8.d. The employer is still responsible for ensuring the system used is approved, completed, installed, and used as designed.

(9) Strength Requirements. Design toprails and midrails to meet the following strength requirements:

(a) Toprail must be capable of withstanding, without failure, a force of at least 200 pounds (0.9 kN) applied within 2 inches (5.1 cm) of the top edge, in any outward or downward direction, at any point along the top edge.

(b) When the previously stated force (that is, 200 pounds within 2 inches (0.9 kN within 5.1 cm)) is applied to the toprail in a downward direction, the top edge of the top rail must not deflect more than 3 inches (7.6 cm) nor to a height less than 39 inches (99 cm) above the walking or working level.

(c) Midrails, screens, mesh, intermediate vertical members, solid panels, and equivalent structural members must withstand, without failure, a force of at least 150 pounds (0.67 kN) applied in any downward or outward direction at any point along the midrail or other member.

(d) Provide guardrails receiving heavy stresses from workers trucking or handling materials with additional strength by using heavier stock, closer spacing of posts, bracing, or by other means.

(10) Minimum Construction Materials for Standard Guardrail Components. The following guidelines may be used as a starting point for designing a guardrail system, however, the employer is still responsible for designing and assembling these components in such a way that the completed system meets the requirements of this paragraph 21-8.d.

(a) Wood railings. Wood railing components must be minimum 1,500 lb-ft/in² (10,342 kPa) fiber (that is, stress grade) construction grade lumber.

(a-1) Toprails. Constructed using at least 2 inches x 4 inches (5.1 cm x 10.2 cm) lumber.

(a-2) Midrails. Constructed using at least 1 inch x 6 inches (2.5 cm x 15.2 cm) lumber.

(a-3) Posts. Constructed using at least 2 inches x 4 inches (5.1 cm x 10.2 cm).

(b) Structural steel railings.

(b-1) Toprails and midrails. At least 2 inches x 2 inches x 3/8 inch (5.1 cm x 5.1 cm x 0.9 cm) angles.

(b-2) Posts. At least 2 inches x 2 inches x 3/8 inch (5.1 cm x 5.1 cm x 0.9 cm) angles spaced not more than 8 feet (2.4 m) on centers.

(c) Steel Cable (Wire Rope) railings.

(c-1) Toprails and midrails must be at minimum, one-quarter (1/4) inch (0.6 cm) steel cable and flagged every 6 feet (1.8 m) with high visibility material. Tension the cables so there is not more than 3 inches (7.6 cm) deflection, in any direction from the center line, under a 200 pounds (0.89 kN) load.

(c-2) Locate support posts to ensure proper tension is maintained.

(c-3) Perimeter safety cables must meet the criteria and requirements for guardrail systems. If the perimeter safety cables are used by the workers as a method

of attaching a lanyard to the cables, then they must meet the requirements of HLL System. (See para 21-8.c)

(11) Hoist Areas. When guardrails are used at hoisting areas, erect a minimum 6 feet (1.8 m) of guardrail on each side of the access point through which materials are hoisted.

(a) A gate or removable guardrail section may be used as long as it meets the standard guardrail height 42 +/- 3 inches (106.7 +/- 7.6 cm) and is secured across the opening between the guardrail sections when hoisting operations are not taking place.

(b) During hoisting operations, if a segment or side of the railing system is required to be left open for easy access at an unprotected side, edge, or hatch, use self-closing swing gates, chain, removable guardrail section or PFAS and restraint system to protect personnel from falling.

e. Existing Parapet Walls (Passive Fall Protection Systems). To be considered an effective fall protection method, parapet walls must be 42 +/- 3 inches (106.7 +/- 7.6 cm) in height. If the height of an existing parapet does not meet the appropriate height requirements, consider installing a guardrail system to provide the necessary protection, or use another method of fall protection. (21-8.e)

f. Covers (Passive Fall Protection Systems). Install covers on all holes. (21-8.f)

(1) Covers must support at least twice the weight of the worker, equipment, and material combined.

Note. Consider all equipment and material (for example, aerial lifts, rolling scaffolds) in the workplace when designing covers.

(2) Secure covers in place and clearly marked with the word "HOLE," "COVER," or "Danger, Roof Opening-Do Not Remove," color-code them, or use an equivalent method (for example, red or orange "X"). Inform all workers of the meaning of the color coding and equivalent methods.

g. Safety Net Systems (Passive Fall Protection Systems). Design, install, use, and maintain safety net systems for fall protection according to ANSI/ASSP A10.11 and 29 CFR 1926.502 (29 CFR 1926 Subpart M). (21-8.g)

Note. See chapter 14 for debris nets.

(1) Install safety nets as close under the work surfaces as practical, but in no case more than 30 feet (9.1 m) below the work surface. Hang nets with sufficient clearance to prevent contact with the surfaces or structures below. Determine the clearance by impact load testing.

(2) When nets are used on bridges, multi-story buildings or structures, ensure that the potential fall area from the walking or working surface to the net is unobstructed.

(3) The maximum size of the mesh openings must not exceed 36 in² (232.3 cm²), nor be longer than 6 inches (15.2 cm) on any side.

(4) The border rope or webbing must have a minimum breaking strength of 5,000 pounds (22.2 kN).

(5) Do not perform work requiring safety net protection until the nets are in place and have either been tested without failure according to the following procedures, or a QP states otherwise.

(a) Test safety nets and safety net installations while in the suspended position immediately after installation. Perform the tests under the supervision of QP and in the presence of the USACE supervisor/KO or COR. Test whenever nets are relocated, after any major repair, and at least every six months if left in place for extended periods.

(b) Perform a drop test. Use a 400 lb. (181.4 kg) bag of sand that is not more than 30 inches +/- 2 inches (76.2 cm +/- 5.1 cm) in diameter. Drop the bag from at least 42 inches (106.7 cm) above the highest working or walking surface at which workers are exposed to fall hazards. Ensure the weight can be safely retrieved after the test is conducted.

(c) The drop test is not necessary if a QP certifies in writing that it is unreasonable to perform the drop test. The certification must state that the net and its installation, to include anchorages, are in compliance with manufacture's recommendations, this manual, applicable federal, state, and local requirements. The QP must sign the certification and include an identification of the net and net installation, and the certification date. Maintain a copy of the certification at the jobsite.

(6) Use only shackles and hooks made of forged steel.

(7) When debris nets are used with safety nets, secure them on top of the safety net. Ensure that they do not compromise the design, construction, or performance of the safety nets.

(8) Remove any materials, scrap pieces, equipment, and tools that have fallen into the safety net as soon as possible and at least before the next work shift. Protect safety nets from sparks and hot slag resulting from welding and cutting operations.

(9) If any welding or cutting operations occur above the nets, provide noncombustible barriers. Increase the frequency of inspections in proportion to the potential for damage to the nets. (See para 21-5.b)

h. Other Engineered Fall Protection Systems. Commercially available engineered and integrated systems are recognized as effective fall protection and may be used provided the requirements of paragraph 21-8.h are met. (21-8.h)

(1) A QP must design, install, certify, and supervise the use of all commercially available engineered and integrated systems. They must be used according to the manufacturer's instructions and recommendations. The CP may, if deemed appropriate by and under the direction of a QP, supervise the assembly, disassembly, use, and inspection of the engineered system.

(2) The design must include drawings, required clearances, and instructions on proper installation, use, and inspection requirements. The USACE supervisor must approve or the KO or COR must accept these systems as part of the Fall Protection and Prevention Plan.

i. Warning Line System (WLS) (Administrative Control). (21-8.i)

(1) Construction Roofing Activities on Low-Sloped Roofs. Employees engaged in construction roofing activities on low-sloped roofs (that is, 18.4°, 4:12 slope) with unprotected sides and edges 6 feet (1.8 m) or more above lower levels can utilize a WLS. At minimum, the WLS must be used in combination with a safety monitor system (see 29 CFR 1926.501(b)(10) and 1926.502(h) (29 CFR 1926 Subpart M)). WLS must comply with the following:

(a) The warning line must be erected around all sides of the roof work area.

(b) When mechanical equipment is not being used, the warning line must be erected not less than 6 feet (1.8 m) from the roof edge.

(c) When mechanical equipment (as defined by 29 CFR 1926.500(b) (29 CFR 1926 Subpart M)) is being used, the warning line must be erected not less than 6 feet (1.8 m) from the roof edge which is parallel to the direction of mechanical equipment operation, and not less than 10 feet (3 m) from the roof edge which is perpendicular to the direction of mechanical equipment operation.

(d) Points of access, materials handling areas, storage areas, and hoisting areas must be connected to the work area by an access path formed by two warning lines.

(e) When the path to a point of access is not in use, a rope, wire, chain, or other barricade, equivalent in strength and height to the warning line, must be placed across the path at the point where the path intersects the warning line erected around the work area, or the path must be offset such that a person cannot walk directly into the work area.

(f) Warning lines must consist of ropes, wires, or chains, and supporting stanchions erected as follows:

(f-1) The rope, wire, or chain must be flagged at not more than 6 feet (1.8 m) intervals with high-visibility material.

(f-2) The rope, wire, or chain must be rigged and supported in such a way that its lowest point (including sag) is no less than 34 inches (86.4 cm) from the walking/working surface and its highest point is no more than 39 inches (99.1 cm) from the walking/working surface.

(f-3) After being erected, with the rope, wire, or chain attached, stanchions must be capable of resisting, without tipping over, a force of at least 16 pounds (0.07 kN) applied horizontally against the stanchion, 30 inches (76.2 cm) above the walking/working surface, perpendicular to the warning line, and in the direction of the floor, roof, or platform edge.

(f-4) The rope, wire, or chain must have a minimum tensile strength of 500 pounds (2.22 kN), and after being attached to the stanchions, must be capable of supporting, without breaking, the loads applied to the stanchions as prescribed above.

(f-5) The line must be attached at each stanchion in such a way that pulling on one section of the line between stanchions will not result in slack being taken up in adjacent sections before the stanchion tips over.

(g) An additional fall protection system is required when working outside the WLS.

(h) Mechanical equipment on roofs must be used or stored only in areas where employees are protected by a WLS, guardrail system, or PFAS.

(2) Construction Activities on Low-Sloped Roofs Regardless of Trade. Applies to Contractors only. USACE employees are not permitted to use WLS in this manner.

(a) Contractor employees engaged in construction, non-roofing activities on low-sloped roofs (that is, 18.4°, 4:12 slope) with unprotected sides or edges 6 feet (1.8 m) or more above lower levels can utilize a WLS. The WLS must comply with the following:

(a-1) The warning line is erected at least 15 feet from the edge or nearest edge of a hole.

(a-2) The warning line meets or exceeds the requirements of paragraph 21-8.i and 29 CFR 1926.502(f)(2) (29 CFR 1926 Subpart M).

(a-3) No work or work-related activity is performed in the area between the warning line and the hole or edge.

(a-4) The employer effectively implements a work rule prohibiting employees from going past the warning line.

Note. Paragraph 21-8.i(2) is not in compliance with current OSHA standards, however, OSHA has issued response that a warning line erected at least 15 feet from an edge or hole combined with effective work rules can be expected to prevent employees from going past the line and approaching the fall hazard. In addition, at a distance of 15 feet, the absence of a barrier to restrain employees from unintentionally crossing the line would not place the employee in immediate risk of the fall hazard. Therefore, OSHA will apply a de minimis policy for non-conforming guardrails for WLS used in this manner.

(b) Contractors must determine if paragraph 21-8.i(2)(a) is acceptable to complete their work activities. Procedures and work practices must be documented in their Fall Protection and Prevention Plan (see para 21-7).

j. Designated Areas (Administrative Control). A designated area is a distinct portion of a walking-working surface delineated by rope, wire, tape, or chain in which employees may perform work without additional fall protection during general industry type work (for example, inspecting or maintaining HVAC equipment). Working within a designated area does not require additional fall protection, however, if working outside the designated area, another form of fall protection must be provided when personnel are exposed to fall hazards (see figure 21-2). When the employer uses a designated area, the employer must ensure the following: (21-8.j)

(1) Employees remain within the designated area while work operations are underway.

(2) The perimeter of the designated area is delineated with rope, wire, tape, or chain that has a minimum breaking strength of 200 pounds (0.89 kN) and is installed so its lowest point, including sag, is not less than 34 inches (86.4 cm) and not more than 39 inches (99.1 cm) above the walking-working surface.

(3) Is supported in such a manner that pulling on one section of the line will not result in slack being taken up in adjacent sections causing the line to fall below the limits specified above.

(4) Is clearly visible from a distance of 25 feet (7.6 m) away, and anywhere within the designated area.

(5) Is erected as close to the work area as the task permits.

(6) Is erected not less than 6 feet (1.8 m) from the roof edge for work that is both temporary and infrequent, or not less than 15 feet (4.6 m) for other work.

(7) When mobile mechanical equipment is used to perform work that is both temporary and infrequent in a designated area, the employer must ensure the rope,

wire, tape, or chain is erected not less than 6 feet (1.8 m) from the unprotected side or edge that is parallel to the direction in which the mechanical equipment is operated, and not less than 10 feet (3 m) from the unprotected side or edge that is perpendicular to the direction in which the mechanical equipment is operated. See 29 CFR 1910.29(d) (29 CFR 1910 Subpart D).

k. Safety Monitoring System (SMS) (Administrative Control). An SMS can only be used in combination with a passive, active, or additional administrative control (for example, warning line system (see para 21-8.i)). The use of an SMS as fall protection method, when used independently, is prohibited. See chapter 37 and figure 39-1 for exemption. (21-8.k)

l. Controlled Access Zones. USACE does not recognize Controlled Access Zones as acceptable for controlling exposure to fall hazards, and therefore, cannot be used independently as a fall protection method. (21-8.l)

m. Scaffolds. (21-8.m)

(1) Supported Scaffolds.

(a) When possible, equip scaffolds with a standard guardrail system according to paragraph 21-8.d. If a guardrail system is not possible, use another fall protection system or method (for example, personal fall protection).

(b) For workers erecting and dismantling scaffolds, a CP must conduct an evaluation to determine the feasibility and safety of providing fall protection. If fall protection is not feasible, submit an AHA detailing rationale for infeasibility of use of fall protection for approval by the USACE supervisor or acceptance by the KO or COR. (See para 21-6.a)

(2) Suspended scaffolds.

(a) For single point or two point suspended scaffold, in addition to railings, workers must also tie off to an independent vertical lifeline using a full body harness.

(b) For other suspended scaffolds (for example, catenary, float, needle-beam, boatswain chairs), workers must use a PFAS tied off to an independent vertical lifeline using a full body harness.

(c) Perform a risk assessment when persons are supported on a multi-point adjustable suspended scaffold to evaluate the effectiveness and feasibility of the use of PFASs. Document the risk in the AHA for the activity being performed.

n. Self-Propelled Elevating Work Platforms (Scissor Lifts). The term “scissor lifts” is used to mean all type of self-propelled elevating work platforms having a platform that cannot be positioned completely beyond the base (see ANSI/SAIA A92.6). (21-8.n)

(1) All scissor lifts must be equipped with standard guardrails.

(2) All scissor lifts must be equipped with anchorages according to ANSI/ASSP Z359.1.

Note. Do not use scissor lifts unless they are equipped with anchorages.

(3) Use restraint systems on all scissor lifts. The lanyards, to include adjustable energy absorbing lanyards, used in the restraint system, must be sufficiently short to provide fall restraint and prohibit workers from climbing out of or being ejected from the platform.

(4) Do not use an SRD unless permitted by both the scissors lift and SRD manufacturers and used according to the manufacturers' instructions.

(5) Do not climb on or over the guardrails.

o. Aerial Work Platforms (AWPs) (non-Scissor Lifts). These are boom supported elevating work platforms (see ANSI/SAIA A92.5) and vehicle mounted rotating and elevating aerial devices (see ANSI A92.2). (21-8.o)

(1) Use restraint systems or PFAS on all AWP's. Workers must anchor themselves to the basket or bucket according to the manufacturer's specifications and instructions. Do not anchor to the boom unless allowed by the manufacturer and approved by the CP.

(2) Lanyards, to include adjustable energy absorbing lanyards, used in the restraint system must be sufficiently short to provide fall restraint and prohibit workers from climbing out of or being ejected from the platform.

(3) Lanyards with built-in shock absorbers are acceptable.

(4) Do not use an SRD unless permitted by both the aerial work platform and SRD manufacturers and used according to the manufacturers' instructions.

(5) Do not tie off to an adjacent pole or structure unless a safe device for 100% tie-off is used for the transfer.

p. Manually Propelled Elevating Work Platforms (see ANSI/SAIA A92.3). (21-8.p)

(1) All manually propelled elevating work platforms must be equipped with standard guardrails.

(2) If the platform is equipped with anchorages meeting the ANSI Z359, use a restraint system in addition to the guardrails.

(3) The lanyards, to include adjustable energy absorbing lanyards, used in the restraint system, must be sufficiently short to provide fall restraint and prohibit workers from climbing out of or being ejected from the platform.

(4) Adjustable energy absorbing lanyards with built-in shock absorbers are acceptable.

(5) Do not use an SRD unless permitted by both the work platform and SRD manufacturers and used according to the manufacturers' instructions.

(6) Do not occupy a platform when being moved.

(7) Do not climb on or over the guardrails.

q. Fall Protection Requirements when Conducting Inspection, Investigation, or Assessment Work. (21-8.q)

(1) During construction or general industry work activities, fall protection is required for employees exposed to fall hazards while conducting inspection, investigation, or assessment work.

(2) Ensure that the conventional fall protection system (that is, guardrail, safety net or personal fall protection system) is in place when conducting inspections, investigations, or assessments within 6 feet (1.8 m) from an unprotected edge of a roof or other walking or working surface (that is, within the control zone). A warning line system or designated area is not permitted. The CP must develop an AHA for this activity and submit it to the USACE supervisor for approval or to the KO or COR for acceptance.

Note. For general industry work only, when fall protection systems or equipment have been installed and are available for workers to use for pre-work and post-work inspections, investigations or assessments, the above exemption does not apply.

(3) Prior to start of construction or after construction work is complete, fall protection may not be required when conducting inspection, investigation, or assessment work more than 6 feet (1.8 m) away from an unprotected edge of a roof (that is, within the safe zone). The CP must develop an AHA for this activity and submit it to the USACE supervisor for approval or to the KO or COR for acceptance.

(4) During maintenance evolutions (for example, inspecting or maintaining HVAC or other equipment on roofs), fall protection is required when conducting inspection and investigation work.

r. Fall Protection Requirements for Work Performed on Low Sloped Roofs (Only applicable to general industry work). For construction work, see paragraph 21-8.i (WLS). (21-8.r)

(1) When work is performed less than 6 feet (1.8 m) away from the unprotected roof edge, ensure each employee is protected from falling to lower level using a conventional fall protection system (that is, guardrail system, safety net system, personal fall protection system). WLS or designated areas are not permitted.

(2) When work is performed at least 6 feet (1.8 m) but less than 15 feet (4.5 m) away from the unprotected roof edge, ensure each employee is protected from falling by using a conventional fall protection system (that is, guardrail system, safety net system, or personal fall protection system). The use of designated area is acceptable when performing work that is both infrequent and temporary (see para 21-8.i). For lengthy or routine jobs involving exposure to fall hazards, use conventional fall protection systems.

(3) When work is performed 15 feet (4.6 m) or more from the unprotected roof edge:

(a) A fall protection system is not required, provided the work performed is both infrequent and temporary. For lengthy or routine work, use conventional fall protection systems (that is, guardrail system, safety net system, or personal fall protection system) or designated area.

(b) Implement and enforce a work rule prohibiting employees from going within 15 feet (4.6 m) of the unprotected roof edge without using fall protection system.

s. Steep Roofs. When inspection and investigation work is performed on steep roofs (more than 4:12 slope), use conventional fall protection system (that is, guardrail system, safety net system, or personal fall protection system). (21-8.s)

t. Working at Height Over or Near Water. The employer must ensure a QP or CP identifies and determines: (21-8.t)

(1) Task specific SOH requirements for working at height over or near water activities and document it in the Fall Protection Plan and/or AHA prior to work. Abide by all applicable OSHA standards.

(2) Where there are additional hazards (for example, currents, intakes, dangerous machinery, or equipment) present, a fall protection system will be required regardless of the fall distance and PFDs may not be required.

(3) The drowning hazard is removed if continuous fall protection is used (for example, guardrails, personal fall protection) to prevent workers from falling into the water. PFDs may not be required.

(4) The need for fall protection and or PFDs in situations where employees are occupying a boom-attached or suspended personnel platforms over water for construction or marine activities. For example, if an error occurred that resulted in the employees being in the water, would being tied-off increase the drowning hazard?

Personal fall protection equipment may not be needed if PFDs provide better protection. See 29 CFR 1926.106, 29 CFR 1926.453(b)(2)(v), 29 CFR 1926.1431(k)(10)(i), and OSHA's letters of interpretation on these references.

(5) The use of safety nets as fall protection during marine construction activities usually will not eliminate the drowning hazard, so PFDs are usually required. In many cases (such as in bridge construction) there is a risk that materials heavy enough to damage the nets may fall. If required, use safety nets and adequate fall protection.

Note. PFDs must not interfere with proper use of personal fall protection equipment. Follow all manufacturer requirements and chapter 5 of this manual.

21-9. Figures and Tables.

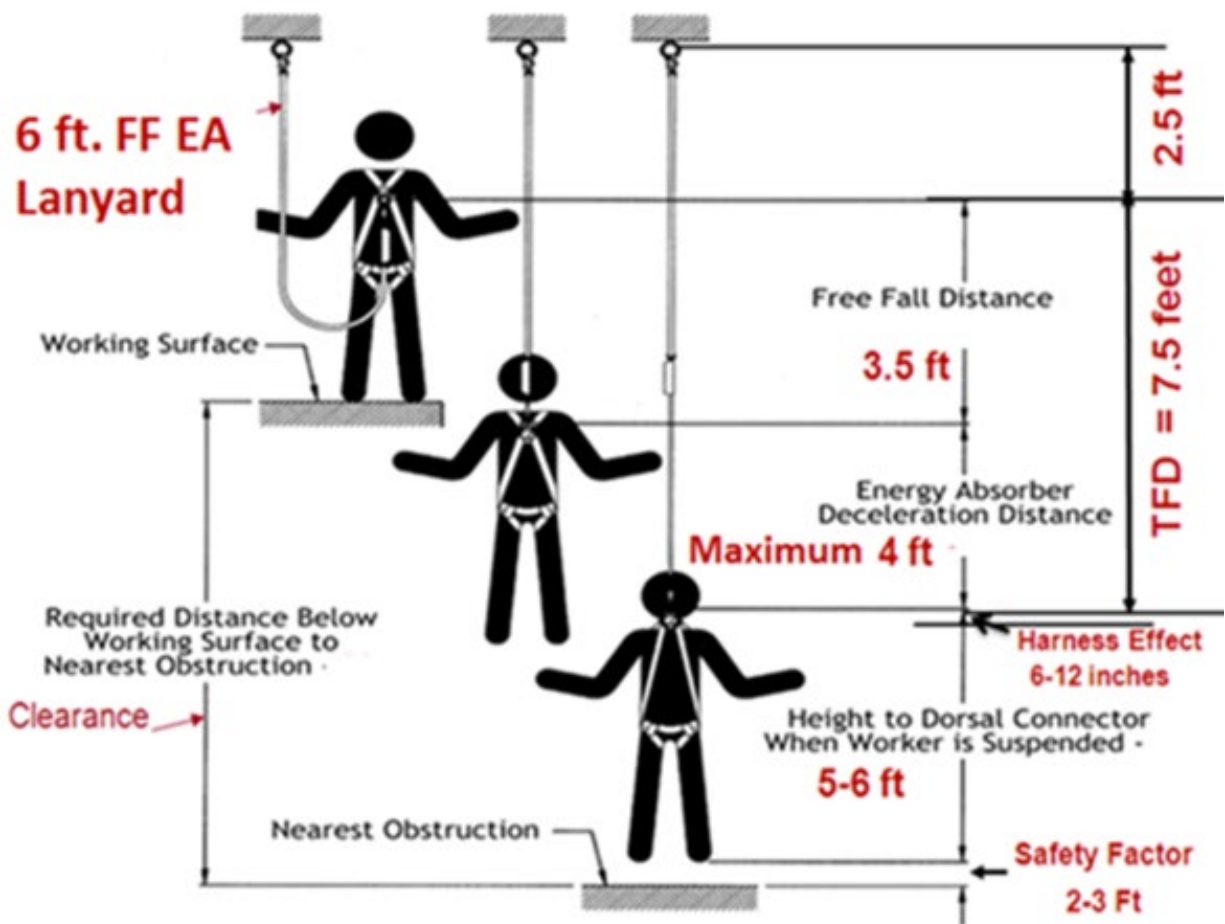
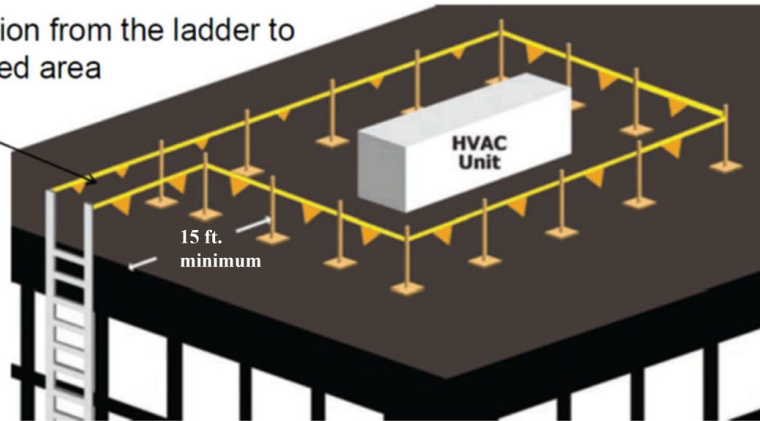

Figure 21-1. Calculating Distance

100% transition from the ladder to the designated area



Note:

- ¹ Used on roofs during maintenance work, that is, inspecting or maintaining HVAC equipment (not roofing work).
- ² Similar to warning line system for construction.

Figure 21-2. Designated Area

21-10. Checklists and Forms.

Not Applicable.

Chapter 22 Work Platforms and Scaffolding

22-1. References.

- a. ANSI/ASSP A10.8, Scaffolding Safety Requirements (<https://www.assp.org>) (22-1.a)
- b. ANSI/American Ladder Institute (ALI) A14.2, Ladders - Portable Metal - Safety Requirements (<https://webstore.ansi.org>) (22-1.b)
- c. ANSI/ALI A14.5, Ladders - Portable Reinforced Plastic - Safety Requirements (<https://webstore.ansi.org>) (22-1.c)
- d. ANSI/SAIA A92.2, Vehicle-Mounted Elevating and Rotating Aerial Devices (<https://shop.saiaonline.org>) (22-1.d)
- e. ANSI/SAIA A92.9, Mast-Climbing Work Platforms (<https://shop.saiaonline.org>) (22-1.e)
- f. ANSI/SAIA A92.20, Design, Calculations, Safety Requirements and Test Methods for Mobile Elevating Work Platforms (<https://shop.saiaonline.org>) (22-1.f)

- g. ANSI/SAIA A92.22, Safe Use of Mobile Elevating Work Platforms (<https://shop.saiaonline.org>) (22-1.g)
- h. ANSI/SAIA A92.24, Training Requirements for the Use, Operation, Inspection, Testing, and Maintenance of Mobile Elevating Work Platforms (<https://shop.saiaonline.org>) (22-1.h)
- i. ANSI/Industrial Truck Standards Development Foundation B56.6, Safety Standard for Rough Terrain Lift Trucks (<https://webstore.ansi.org>) (22-1.i)
- j. IPAF/SAIA, Guidelines for the Safe Use of Mast Climbing Work Platforms (<https://www.ipaf.org/en-us/resource-library/guidelines-safe-use-mast-climbing-work-platforms>) (22-1.j)
- k. SAIA/Scaffolding, Shoring & Forming Institute Publication SP201, Code of Safe Practices for Frame Scaffolds, System Scaffolds, Tube and Clamp Scaffolds & Rolling Scaffolds (<https://www.saiaonline.org/scaffolding>) (22-1.k)
- l. Voluntary Product Standard PS 20-20, American Softwood Lumber Standard (https://www.wbdg.org/ffc/nist/voluntary-product-standards/nist_ps20) (22-1.l)
- m. 29 CFR 1926.451, General Requirements (<https://www.govinfo.gov/content/pkg/CFR-2019-title29-vol8/pdf/CFR-2019-title29-vol8-sec1926-451.pdf>) (22-1.m)
- n. 29 CFR 1926.452, Additional Requirements Applicable to Specific Types of Scaffolds (<https://www.govinfo.gov/content/pkg/CFR-2019-title29-vol8/pdf/CFR-2019-title29-vol8-sec1926-452.pdf>) (22-1.n)
- o. 29 CFR 1926 Subpart CC, Cranes and Derricks in Construction (<https://www.govinfo.gov/content/pkg/CFR-2022-title29-vol8/pdf/CFR-2022-title29-vol8-part1926-subpartCC.pdf>) (22-1.o)
- p. 29 CFR 1926 Subpart L, Scaffolds (<https://www.govinfo.gov/content/pkg/CFR-2020-title29-vol8/pdf/CFR-2020-title29-vol8-part1926-subpartL.pdf>) (22-1.p)
- q. 29 CFR 1926 Subpart X, Stairways and Ladders (<https://www.govinfo.gov/content/pkg/CFR-2020-title29-vol8/pdf/CFR-2020-title29-vol8-part1926-subpartX.pdf>) (22-1.q)

22-2. Definitions.

a. Competent Person (CP), Scaffolding. A person designated in writing by the employer to be responsible for immediate supervision, implementation, and monitoring of the Scaffold Work Plan. Must have training, knowledge, and experience in scaffolding to be capable of identifying, evaluating, and addressing existing and

potential hazards. This individual must have the authority to take prompt corrective measures with regard to such hazards. The term “Competent Person (CP),” as used in this chapter, refers to “Competent Person, Scaffolding.” (22-2.a)

b. Float/Ship Scaffold. A scaffold hung from overhead supports by means of ropes and consisting of a unit having diagonal bracing underneath. The scaffold rests upon and is securely fastened to two parallel planks bearers at right angles to the span. (22-2.b)

c. Ledger. A horizontal scaffold member upon which bearers rest; the longitudinal member that joins scaffold uprights, posts, poles, and similar members. (22-2.c)

d. Mast Climbing Work Platform (MCWP). A hoist having a working platform used for temporary purposes to raise personnel and materials to the working position by means of a drive system mounted on an extendable mast which may be tied to a building. (22-2.d)

e. Mobile Elevating Work Platforms (MEWP). Any vehicle mounted device, telescoping, or articulating, or both, which is used to position or elevate personnel to jobsites or activities above the ground. May be made of other material (metal, wood, fiberglass reinforced plastic or other); may be power or manually operated; includes: (22-2.e)

(1) Aerial Ladder. An aerial device consisting of a single- or multiple-section extendable ladder.

(2) Articulating Boom Platform. An aerial device with two or more hinged boom sections.

(3) Insulated Aerial Device. An aerial device designed for work on energized lines and apparatus.

f. Mudsill. A 2 inch x 10 inch x 8 inch (5.1 cm x 25.4 cm x 20.3 cm) (minimum) wood plate that is used to distribute the scaffolding load over a suitable ground area. (22-2.f)

g. Outrigger. Extendable or fixed structural members with one end attached to the base of a piece of equipment and the other end resting on floats on the ground used to distribute loads in supporting equipment. (22-2.g)

h. Platform. A work surface elevated above lower levels. Platforms can be constructed using individual wood planks, fabricated planks, fabricated decks, and fabricated platforms. (22-2.h)

i. Qualified Mast-Climbing Work Platform (MCWP) Operator. An employee designated in writing by the employer that has been trained by a CP for Scaffolding;

must be able to recognize hazards associated with mast-climbing scaffolds; have specific equipment familiarization prior to operation. (22-2.i)

j. Qualified Person (QP). See paragraphs 1-2 or 2-2, as applicable. (22-2.j)

k. Registered Professional Engineer (RPE). See paragraphs 1-2 or 2-2, as applicable. (22-2.k)

l. Runway. A personnel passageway elevated above the surrounding floor or ground level, such as a foot walk along shafting or a walkway between scaffolds. (22-2.l)

m. Scaffold. Temporary elevated platform (supported or suspended) and its supporting structure (including anchorage points), used for supporting employee(s), materials, or both. (22-2.m)

n. Scaffold, Hanging. A scaffold/work platform that is hung from a location (such as a lock gate) for work to be performed and that remains stationary until it is then repositioned with a crane/hoisting device. (22-2.n)

o. Scaffold, Load Ratings. Maximum loadings for the following categories: (22-2.o)

(1) Heavy Duty. A scaffold designed and constructed to carry a working load of 75 lbs/ft² (3.2 kg/m²), that is intended for stone masonry work, with storage material on the platform.

(2) Medium Duty. A scaffold designed and constructed to carry a working load of 50 lbs/ft² (2.1 kg/m²), that is intended for bricklayers or plasterers, with weight of material in addition to workers.

(3) Light Duty. A scaffold designed and constructed to carry specific working load of 25 lbs/ft² (1.1 kg/m²), that is intended for workers only, with no material storage other than weight for tools.

(4) Special Duty. A scaffold designed and constructed to carry specific types of objects, such as palletized materials. The design of planks and other types of scaffold units, the scaffold, and accessories will be based on categories of load ratings.

p. Scaffold, Mason's Multiple-Point Adjustable Suspension. A scaffold having a continuous platform supported by bearers suspended by wire rope hoists from overhead supports. (22-2.p)

q. Scaffold, Metal Frame. A scaffold consisting of a work platform supported by prefabricated metal frames. (22-2.q)

r. Scaffold, Needle-Beam. A platform resting on two bearers that is suspended by a line. (22-2.r)

s. Scaffold, Pump Jack. A scaffold consisting of a work platform supported by movable support brackets mounted on vertical poles. (22-2.s)

t. Scaffold, Trestle Ladder. A work platform supported by a trestle ladder. A trestle ladder is self-supporting portable ladder that can be adjustable in length, consisting of two sections, hinged at the top to form equal angles with the base. (22-2.t)

u. Scaffold, Tube and Coupler. A scaffold consisting of a work platform supported by individual pieces of tubing (uprights, bearers, runners, bracing) connected with couplers. (22-2.u)

v. Scaffold, Two-Point Suspension (swinging scaffold/swinging stage). A suspension scaffold consisting of a platform supported by hangers (stirrups) suspended by two ropes from overhead supports and equipped with means to raise and lower the platform. (22-2.v)

w. Scaffold, Window Jack. A supported scaffold consisting of a platform supported by a bracket or jack that projects through a window opening. (22-2.w)

x. Supported Scaffolds. One or more platforms supported by outrigger beams, brackets, poles, legs, uprights, posts, frames, or similar rigid support such as frame scaffolds or fabricated frame, pole or wood pole, mobile scaffolds, mast climbing scaffolds. (22-2.x)

y. Turbine Maintenance Platforms (TMPs). A type of scaffold unique to hydropower operations and maintenance that incorporates aspects of both suspended scaffolds and hanging scaffolds. These TMPs are assembled in the draft tube below the turbine where they are physically attached to the structure. Some TMPs must be assembled below the turbine at the draft tube door level and raised into position and may also be required to be close to the turbine blades such that the TMP must wrap around the turbine hub. This applies to vertical access turbines where the TMP is assembled under the runner. (22-2.y)

z. Vehicle-Mounted Elevating and Rotating Work Platforms. An elevating and rotating work platform mounted on the chassis of a commercial vehicle. (22-2.z)

22-3. Personnel Required Qualification/Training.

a. Scaffold Users. (22-3.a)

(1) Personnel must be qualified and properly trained prior to utilizing work platforms and scaffolding or training others on the various systems.

(2) The employer must provide training to each employee who performs work while on a scaffold. Training must be conducted by a person qualified in the subject matter to recognize the hazards associated with the type of scaffold being used and to understand the procedures to control or minimize those hazards. The training must include the following areas, as applicable:

(a) The nature of any electrical hazards, fall hazards, and falling object hazards in the work area.

(b) The correct procedures for dealing with electrical hazards and for erecting, maintaining, and disassembling the fall protection systems and falling object protection systems being used.

(c) The proper use of the scaffold, and the proper handling of materials on the scaffold.

(d) The maximum intended load and the load-carrying capacities of the scaffolds used.

(e) Reading and understanding the manufacturer's operating manual and any associated rules and instructions and understanding all decals and warnings.

(f) Any other pertinent requirements of OSHA, applicable ANSI standard, and the manufacturer's instructions.

Note. All non-user trained personnel (for example, building inspectors, consultants) that may need to be on a scaffold must have as a minimum, safety/hazard awareness training, and be escorted by a trained user while on the scaffold.

b. Competent Person (CP), Scaffolding. CPs must meet the following training and qualification requirements: (22-3.b)

(1) Have a documented minimum of 8-hours of scaffold training, to include training on the specific type of scaffold being used (for example, mast climbing, adjustable, tubular frame).

(2) Be experienced on the specific scaffolding systems/types, assessment of the base material the scaffold will be erected upon, load calculations for materials and personnel, erection, and dismantling.

(3) Have training with special steps for installation.

(4) Knowledgeable in the drawing and how the scaffold/platform is installed and removed from the areas it is installed.

(5) CP training requirements are determined by the employer but must include:

(a) Assessment of the base material the scaffold will be erected upon.

(b) Load calculations for materials and personnel.

(c) Erection and dismantling.

(d) Meet the training requirements in the applicable ANSI standard.

c. Erectors and Dissembler Personnel. Anyone involved in erecting, disassembling, moving, operating, using, repairing, maintaining, or inspecting a scaffold must be trained by a CP to recognize any hazards associated with the work in question. Proof of training must be maintained onsite and made available to the USACE supervisor/KO or COR upon request. The training must include the following areas, as applicable: (22-3.c)

(1) Reading and understanding the manufacturer's operating manual and any associated rules and instructions, or training by a QP on the contents on these documents.

(2) Reading and understanding all decals, warnings, and instructions on the device.

d. Mobile Elevating Work Platforms (MEWP) Operators. All MEWP operators must have training that includes both general as well as equipment- specific familiarization before being allowed to operate this equipment. Training records must be maintained for at least three years and maintained onsite. (22-3.d)

e. Mobile Elevating Work Platforms (MEWP) Occupants. Anyone occupying a MEWP must have instruction to operate an MEWP in the event of an emergency and the operator cannot perform this function. This instruction does not give the occupant authorization to operate the controls at any time except in an emergency. The instruction must give the occupant the ability to perform lowering procedures for the MEWP according to ANSI A92.24. (22-3.e)

22-4. Roles and Responsibilities.

a. Competent Person (CP), Scaffolding will: (22-4.a)

(1) Provide oversight of employees who erect, dismantle, move, or alter scaffolds, determine if it is safe for employees to work on or from a scaffold during storms or high winds, and to ensure that a personal fall arrest system or wind screens protect these employees.

(2) Provide training for employees involved in erecting, disassembling, moving, operating, repairing, maintaining, or inspecting scaffolds to recognize associated work hazards.

(3) Inspect scaffolds and scaffold components for visible defects before each work shift and after any occurrence which could affect the structural integrity and to authorize prompt corrective actions (see para 22-5).

(4) Inspect ropes on suspended scaffolds prior to each work shift and after every occurrence which could affect the structural integrity and take prompt corrective actions.

(5) Determine the feasibility and safety of providing fall protection and access.

(6) Evaluate the space between a hanging scaffold platform deck ends and the face of the vertical structure prior to use on each jobsite to determine if the space constitutes a hazard.

b. Registered Professional Engineer (RPE). When an RPE is required by 29 CFR 1926 Subpart L they will: (22-4.b)

(1) Stamp all designs that are not “off-the-shelf” scaffolding components or connections commercially available and certified by the manufacturer for use on scaffolds.

(2) Design and detail scaffolds according to this manual and any standard referenced.

(3) Provide stamped calculations and drawings for designs.

(4) Design drawings and specifications for all frame scaffolds over 125 feet (38.1 m) in height above the base plates must be designed by an RPE.

(5) Design mason’s multiple adjustable suspension scaffold connections.

(6) Design hanging scaffolds (see para 22-8.g).

(7) Design and certify TMP (see para 22-8.r).

c. Mobile Elevating Work Platforms (MEWP) Operators. Before operating an MEWP, the operator will: (22-4.c)

(1) Survey the work area for loose or soft ground, ditches, drop-offs or holes, bumps and floor obstructions, debris, overhead obstructions, ground and elevated energy sources, and other possible hazards.

(2) Ensure the MEWP is on a firm, level surface.

- (3) Ensure the MEWP is loaded according to the manufacturer's instructions.
- (4) Ensure that outriggers and/or stabilizers are used if required by the manufacturer.
- (5) Ensure that, if the vehicle is on wheels, the wheels are locked or chocked.
- (6). Ensure that the appropriate fall protection system is connected.

22-5. Inspection Requirements.

a. A CP must inspect all scaffold and scaffold components (for example, guardrails, planking, rope, brakes, governors, connections) for visible defects before each work shift, and after any occurrence which could affect a scaffold's structural integrity. (22-5.a)

b. A CP must inspect scaffolding that has been hoisted after configuration or assembly before initial use and again after each hoisting. This inspection must be documented on the scaffold inspection tag. (22-5.b)

c. All scaffold inspections must be documented on a scaffold inspection tag and all scaffolds will be tagged by the CP prior to use. Tags must meet the following: (22-5.c)

- (1) Include name and signature of the CP.
- (2) Include dates of initial and all daily inspections.
- (3) Be readily visible, legible, and made from materials that will withstand the elements.
- (4) Include wording that states one of the following:
 - (a) Scaffold is complete and safe to use,
 - (b) Scaffold is incomplete, not ready for use and reasoning,
 - (c) Scaffold is incomplete and unsafe to use.

Note. Tags are not required for MEWP.

Note. Colored coded scaffold tags are recommended. Example, green indicated a scaffold is complete and safe for use, yellow indicates a scaffold is incomplete, and red indicates a scaffold is unsafe to use.

d. Mast Climbing Work Platform (MCWP). A CP must perform and document daily maintenance inspections according to this manual, OSHA, and the manufacturer's instructions. Maintain copies of the inspection on the jobsite. (22-5.d)

e. Turbine Maintenance Platforms (TMP). (22-5.e)

(1) A CP must perform visual inspections according to this manual, OSHA, and manufacturer's instructions.

(2) TMP Testing. Immediately after fabrication and after any modification of the structural members, proof test the platform to 100% of its rated capacity. The test may take place in the fabricator's shop or other location provided the supports and connections are also tested to 100%. The full rated load must be statically applied for a minimum of 15 minutes. Following the load test, the TMP must be inspected for plastic deformation, fracture, and 100% of welds must receive non-destructive inspection.

f. Suspended Scaffolds. (22-5.f)

(1) A CP must inspect ropes on suspended scaffolds prior to each work shift and after every occurrence which could affect the structural integrity and take prompt corrective actions.

(2) Before use, a CP must evaluate direct connections to affirm that the supporting surfaces are capable of supporting the loads to be imposed.

g. Hanging Scaffolds. (22-5.g)

(1) Prior to initial use and after any modification of the structural members or secure attachment points, proof test the platform to 125% of its rated capacity. The test must take place on a structure the scaffold was designed for or a test structure with similar support member characteristics.

(2) Prior to use on each jobsite or placement location, performance test hanging scaffolds to 100% of the maximum intended load for the expected work. This test must be performed with the scaffold attached to the structure in the work location.

h. Work Stands. Inspect work stands for visible defects on a daily basis. Maintain work stands so they remain free of structural damage. (22-5.h)

22-6. Activity Hazard Analysis (AHA) Requirements.

Develop AHAs according to paragraphs 1-6 or 2-6, as applicable. An AHA must be prepared by the workers performing the work. The AHA must address all of the following elements, if applicable. If not applicable, reasoning must be provided:

a. Site conditions (for example, ground conditions, overhead utilities). (22-6.a)

- b. The specific type of scaffolding to be used. (22-6.b)
- c. Scaffold dimensions, to include height, width, depth, and length. (22-6.c)
- d. Calculations for the anticipated loads. (22-6.d)
- e. The name of the CP for Scaffolding. (22-6.e)
- f. The method of marking or barricading to be used. (22-6.f)
- g. The installation and removal steps. (22-6.g)
- h. Fall protection. (22-6.h)
- i. Working over water. (22-6.i)
- j. Fire protection. (22-6.j)
- k. Any other hazards identified. (22-6.k)

Note. The CP must review the AHA with the entire crew immediately prior to the start of work.

22-7. Minimum Plan Requirements.

- a. A Scaffold Work Plan is required for the following scaffold types: (22-7.a)
 - (1) Tube and coupler, regardless of size.
 - (2) Supported scaffolds with a height to base width ratio greater than four to one.
 - (3) Suspended scaffolds.
 - (4) Scaffolds requiring tenting due to weather conditions.
- b. The plan must include the following: (22-7.b)
 - (1) Detailed description of task to include:
 - (a) Scaffold type. Include dimensions, height, width, depth, and length.
 - (b) Scaffold layout.
 - (c) Access and egress (to include emergency egress).
 - (d) The method of marking or barricading to be used.

(e) Site conditions (for example, ground conditions, overhead utilities).

(f) Bracing/tiebacks, if required.

(2) Describe anticipated hazards.

(3) If fall protection is required, include a Fall Protection and Prevention Plan according to paragraph 21-7. Address feasibility and safety of providing fall protection for employees erecting or dismantling supported scaffolds.

(4) Personnel required training/qualification (see para 22-3).

(5) Personnel roles and responsibilities (see para 22-4).

(6) Inspection and oversight methods.

(7) If a scaffold requires an engineer design by 29 CFR 1926 Subpart L, provide the signed RPE design.

22-8. General Requirements.

a. General. This chapter establishes safety requirements for the construction, operation, maintenance, and use of work platforms and scaffolding used in construction, alteration, demolition, operations, and maintenance of buildings and other structures. It does not apply to permanently installed platforms. (22-8.a)

(1) Comply with the following hierarchy and prohibitions when selecting an appropriate work platform:

(a) Only perform work using scaffolds, platforms, or temporary floors unless if the work cannot be safely performed from the ground or similar footing.

(b) Ladders may be used as work platforms only when allowed by manufacturer.

(c) Do not use ladder jacks, lean-to, or prop-scaffolds.

(d) Do not use emergency descent devices as working platforms (see chapter 19).

(2) Do not erect or use work platforms or scaffolds in the immediate vicinity of power lines or electrical conductors until such are insulated, de-energized, or otherwise rendered safe from accidental contact (see chapter 11).

(3) Do not work on scaffolds during storms, high winds, or other adverse weather conditions.

b. Access and Fall Protection. (22-8.b)

(1) Standard railings and handrails for stairs must comply with the requirements of chapter 24.

(2) Standard guardrails must comply with chapter 21.

(3) Scaffold Cross Bracing.

(a) Cross bracing is acceptable in place of a midrail of a guardrail system when the crossing point of two braces is between 20 inches (0.5 m) and 30 inches (0.8 m) above the work platform.

(b) Cross bracing is acceptable as a toprail of a guardrail system when the crossing point of two braces is between 38 inches (96.5 cm) and 48 inches (121.9 cm) above the work platform.

(c) The end points at each upright must not be more than 48 inches (121.9 cm) apart.

(d) Cross bracing cannot be used for both a midrail and top rail.

c. Scaffolds (excludes MEWPs). General requirements for all scaffolds. (22-8.c)

(1) Erection, moving, dismantling, or altering of scaffolding must be under the supervision of a CP for Scaffolding.

(2) Perform inspections according to paragraph 22-5.

(3) Where persons are required to work or pass under a scaffold, provide a screen (consisting of No. 18 gauge US Standard wire one-half ($\frac{1}{2}$) inch (1.3 cm) mesh or the equivalent) between the toe-board and the guardrail and extend over the entire opening, or restrict access to the potential impact area below.

(4) Capacities.

(a) Scaffolds and their components must meet the requirements contained in ANSI A10.8 or other applicable ANSI standard and be capable of supporting without failure at least 4 times the maximum anticipated load.

(b) Direct connections to roofs and floors and counterweights used to balance adjustable suspension scaffolds must be capable of resisting at least 4 times the tipping moment imposed by the scaffold operating at the rated load of the hoist, or 1.5 times (minimum) the tipping moment imposed by the scaffold operating at the stall load of the hoist, whichever is greater.

(5) Design.

(a) The dimensions of the members and materials used in the construction of various working platforms or scaffolds must conform to the sizes shown in the ANSI A10.8 tables.

(b) Factory-fabricated scaffolds and components must be designed and fabricated according to the applicable ANSI standard. When there is a conflict between the ANSI standard and this manual concerning the design or fabrication of factory-fabricated scaffolds, the ANSI standard will prevail.

(c) Load-carrying timber members must be a minimum of 1,500 lb-f/in² (10,342 kPa) (stress grade) construction grade lumber.

(c-1) All dimensions are nominal sizes (except where rough sizes are noted) according to Voluntary Product Standard DOC PS20.

(c-2) Where rough sizes are noted, only rough or undressed lumber of the size specified will satisfy minimum requirements.

(c-3) Lumber must be reasonably straight-grained and free of shakes, checks, splits, cross grains, unsound knots or knots in groups, decay and growth characteristics, or any other condition that will decrease the strength of the material (see para 22-8.c).

(d) When scaffolds are wrapped with tarps, poly enclosures, or similar materials, wind calculations must be calculated by a QP to determine the strength and placement of the ties.

(6) Supporting members and foundations must be of sufficient size and strength to safely distribute loading.

(a) Place supporting members on a firm, smooth foundation that will prevent lateral displacement.

(b) Do not use unstable objects such as barrels, boxes, loose bricks, or concrete blocks as supports.

(c) Plumb and securely brace vertical members (that is, poles, legs, uprights) to prevent swaying or displacement.

(7) Design and construct or select solid wood planking and platform for means of access based upon either the number of persons for which they are rated or the uniform load distribution to which they will be subjected, whichever is the more restrictive.

(8) Scaffolds must be plumb and level unless engineered and designed to contour as the structure does.

(9) Scaffolds (other than suspended scaffolds) must bear on base plates upon mudsills or other adequate firm foundation.

(10) Working levels of work platforms must be fully planked or decked.

(11) Planking.

(a) All wood planking selected for scaffold plank use must be recognized by grading rules established by a recognized independent inspection agency for the species of wood used.

(b) Do not exceed spans of 8 feet (2.4 m) for 2 inches x 10 inches (5.1 cm x 25.4 cm) (nominal), or 10 feet (3 m) for 2 inches x 9 inches (5.1 cm x 22.9 cm) (rough) solid sawn wood planks.

(c) Fabricated planks and platforms may be used in lieu of solid sawn wood planks. Adhere to maximum spans according to the manufacturer's instructions.

(d) Secure planking to prevent loosening, tipping, or displacement, and support or brace to prevent excessive spring or deflection. Use intermediate beams to prevent dislodgement of planks due to deflection.

(e) Fully plank or deck each platform on all working levels of scaffolds between the front uprights and the guardrail supports as follows:

(e-1) Install each platform unit (for example, scaffold plank, fabricated plank, fabricated deck, or fabricated platform) so that the space between adjacent units and the space between the platform and the uprights is no more than 1 inch (2.5 cm) wide, except where the employer can demonstrate that a wider space is necessary (for example, to fit around uprights when side brackets are used to extend the width of the platform).

(e-2) Where the employer makes the demonstration as described above, the platform must be planked or decked as fully as possible and the remaining open space between the platform and the uprights must not exceed 9.5 inches (24.1 cm).

(f) When planking is lapped in a long run, lap each plank at its supports at least 12 inches (30.5 cm). Extend scaffold planks over the end supports at least 6 inches (15.2 cm) (unless the planking is manufactured with restraining hooks or equivalent means of preventing movement), but not more than 12 inches (30.5 cm). Lap or securely fasten work surfaces to the scaffold.

(g) Where the ends of planks abut each other to form a flush floor, position the butt joint at the centerline of a pole so that abutted ends rest on separate bearers.

(h) Position the front edge of all platforms not more than 14 inches (36 cm) from the face of the work unless guardrail systems are erected along the front edge and/or PFAS are used; the maximum distance from the face for plastering and lathing operations is 18 inches (46 cm).

(i) Support or brace planking to prevent excessive spring or deflection and secure and support to prevent loosening, tipping, or displacement.

(j) When a scaffold materially changes its direction, lay the platform planks to prevent tipping according to the following:

(j-1) Lay the planks that meet the corner bearer at an angle first (unless hook-on fabricated planks are used) and extend over the diagonally placed bearer far enough to have a good safe bearing, but not far enough to involve any danger from tipping.

(j-2) Lay the planking running in the opposite direction at an angle so as to extend over and rest on the first layer of planking.

(k) Maintain planks in good condition. Do not use planks when cracks exceed 1.5 times the width of the board, when notches are deeper than 1/3 the width of the plank, or with saw kerfs marks.

(l) When moving platforms to the next level, leave the existing platform undisturbed until the new bearers have been set to receive the platform planks.

(m) Do not store materials on scaffolds or runways in excess of supplies needed for that shift.

(12) Access.

(a) Provide an access ladder or equivalent safe access.

(b) Where a built-in ladder is part of a scaffold system, it must meet the requirements for ladders according to chapter 24.

(c) Climbing of braces is prohibited.

(d) Install an adequate gate (that is, inward swinging or chain guard) at ladder access points.

Note. For most climbing scaffolding, swing scaffold, or other adjustable platform scaffolding systems, follow the fall protection requirements in chapter 21 or the manufacturer's instructions, whichever is more stringent.

(e) Hook-on or attachable ladders must be specifically designed for use with the type of scaffold. Position them so as not to tip the scaffold.

(f) When erecting or dismantling welded frame scaffolds, the end frames may be used as access provided the horizontal members are not more than 22 inches (55.9 cm) apart.

(g) The minimum clear length of the rungs must be at least 16 inches (40.6 cm).

(h) The distance from the supporting surface to the first step of a ladder, stair, or frame designed to be climbed must not exceed 2 feet (0.6 m).

(13) Where the scaffold height exceeds four times the minimum scaffold base dimension (and including the width added by outriggers, if used), the scaffold must be secured to the wall or structure.

(a) Place the first vertical and horizontal tie at this point.

(b) Repeat vertical ties at intervals not greater than 26 feet (7.9 m) with the top tie placed no lower than four times the base dimension from the top of the scaffold.

(c) Place horizontal ties at each end and at intervals not greater than 30 feet (9.1 m).

(d) When more stringent means of securing the scaffold are recommended by the manufacturer or an RPE, follow the more stringent requirements.

(14) When scaffolds are to be partially or fully enclosed, a QP must verify the adequacy of the number, placement, and strength of ties attaching the scaffold to the structure, taking into consideration wind loads and weather.

(15) When vehicles or mobile equipment are used or allowed adjacent to scaffolding, install substantial stop logs or barricades.

(a) The use of a ground guide is recommended, however, in such cases where it is determined that barricades are not feasible or they are not required based on distance, a ground guide will be used.

(b) Do not expose ground guides to potential falling objects from the scaffold or the equipment.

(c) Hanging scaffolds are exempt from this requirement unless the CP determines that vehicles or mobile equipment could pose a hazard to safe operation.

(16) Do not use brackets on scaffolds unless the tipping effect is controlled.

(17) The following types of scaffolds must be designed and constructed according to ANSI A10.8:

- (a) Outrigger scaffolds.
- (b) Needle-beam scaffolds.
- (c) Interior hung scaffolds.
- (d) Bricklayer's square scaffolds.
- (e) Float/ship scaffolds.
- (f) Boatswain's scaffolds.
- (g) Window jack scaffolds.
- (h) Carpenter's bracket scaffolds.
- (i) Form scaffolds.

(18) Submit other types of scaffolding not included in ANSI A10.8 for review and approval by the USACE supervisor or acceptance by the KO or COR. The design must be approved by an RPE, or the system must meet a nationally recognized design standard.

d. Metal Scaffolds and Towers. (22-8.d)

(1) General Requirements:

(a) Do not use scaffold components made of dissimilar metals together unless a CP has determined that galvanic action will not reduce the strength of any component to a level below that required by paragraph 22-8.c.

(b) Securely connect the sections of metal scaffolds and securely fasten all braces.

(c) Provide a ladder or stairway for access that is affixed or built into the metal scaffolds. Position the ladder or stairway so that when in use it will not have a tendency to tip the scaffold.

(2) Tube and Coupler Scaffolds (see 29 CFR 1926.452).

(a) Tube and coupler scaffolds must have posts, runners, and bracing of nominal 2 inches (5.1 cm) (outside diameter) steel tubing or pipe, or if other structural metals are

used, they must be designed to carry an equivalent load. The size of bearers (outside diameter) and the spacing of posts must meet the requirements contained in ANSI A10.8.

(b) Limit tube and coupler scaffolds to heights and working levels according to ANSI A10.8. Drawings and specifications for tube and coupler scaffolds that exceed the limitations in ANSI A10.8 must be designed by an RPE.

(c) Construct all tube and coupler scaffolds to support four times the maximum intended loads according to ANSI A10.8 or as specified by an RPE (with knowledge in structural design).

(d) Erect runners along the length of the scaffold so they are located on both the inside and the outside posts at even heights.

(d-1) When tube and coupler guardrails and midrails are used on outside posts, they may be used in lieu of outside runners. If guardrail systems are removed to other levels, install extra runners to compensate.

(d-2) Interlock runners to form continuous lengths and couple them to each post.

(d-3) Install the bottom runners as close to the base as possible.

(d-4) Place runners not more than 6 feet - 6 inches (2 m) on center.

(e) Bearers.

(e-1) Install bearers transversely between posts.

(e-2) When coupled to the post, bear the inboard coupler directly on the runner coupler. When coupled to the runners, keep the couplers as close to the post as possible.

(e-3) Extend bearers beyond the posts and runners and to provide full contact with the coupler.

(f) Install bracing across the width of the scaffold at the ends of the scaffold at least every fourth level vertically and repeated every third set of posts horizontally.

(f-1) Extend such bracing diagonally from the outer post or runner at this level upward to the inner post or runner at the next level.

(f-2) Install building ties adjacent to bracing.

(g) Install longitudinal diagonal bracing across the inner and outer rows of poles at approximately a 45-degree angle in both directions from the base of the end post upward to the extreme top of the scaffold.

(g-1) Where the longitudinal length of the scaffold permits, repeat such bracing beginning at every fifth post.

(g-2) On scaffolds where the length is shorter than the height, extend the longitudinal bracing diagonally from the base of the end posts upward to the opposite end posts and then in alternating directions until reaching the top of the scaffold.

(g-3) Where conditions preclude the attachment of bracing to the posts, it may be attached to the runners.

(3) Fabricated Frame Scaffolds (Tubular Welded Frame Scaffolds) (see 29 CFR 1926.452).

(a) Space tubular welded panels or frames consistent with the loads imposed.

(b) Properly brace scaffolds by cross, horizontal, or diagonal braces (or combination of these) to secure vertical members together laterally. The cross braces must be of such length as will automatically square and align vertical members so that the erected scaffold is always plumb, square, and rigid. Secure all brace connections.

(c) Set scaffold legs on adjustable bases or plain bases placed on mudsills or other foundations adequate to support the maximum rated loads.

(d) Place frames one on top the other with coupling or stacking pins to provide vertical alignment of the legs.

(e) Where uplift may occur, lock panels together vertically by pins or other equivalent suitable means.

(f) Drawings and specifications for all frame scaffolds over 125 feet (38.1 m) in height above the base plates must be designed by an RPE.

(4) Manually Propelled Mobile Scaffolds, including mobile work stands, such as “baker scaffolds.”

(a) All wheels and casters on rolling scaffolds must have a positive locking device, securely fastened to the scaffold, to prevent accidental movement.

(b) Lock all casters or wheels when a scaffold is occupied.

(c) Apply the force necessary to move the mobile scaffold as close to the base as practical and make provision to stabilize the tower during movement from one location to another.

(d) Use rolling scaffolds only on firm, level, and clean surfaces.

(e) Free-standing mobile scaffold working platform heights must not exceed three times the smallest base dimension.

(f) Do not permit persons to ride on manually propelled scaffolds unless all of the following conditions exist:

(f-1) The ground surface is within 3 degrees of level and free from pits, holes, or obstructions.

(f-2) The minimum dimension of the scaffold base (when ready for rolling) is at least one-half of the height and outriggers, if used, are installed on both sides of staging.

(f-3) The wheels are equipped with rubber or similar resilient tires.

(f-4) All tools and materials are secured or removed from the platform before the scaffold is moved.

Note. Follow all manufacturer's recommendations for use of outriggers.

e. Wood Pole Scaffolds (see 29 CFR 1926.452). (22-8.e)

f. Suspended Scaffolds. See 29 CFR 1926.452 for single-point adjustable suspension scaffolds and for two-point adjustable suspension scaffolds. (22-8.f)

(1) Suspended scaffolds must be designed, constructed, operated, inspected, tested, and maintained according to the operating manual for the device.

(2) All parts of all suspended scaffolds must have a minimum safety factor of four. A minimum safety factor of six is required for support ropes.

(3) Support Ropes.

(a) Attach support ropes at the vertical centerline of the outrigger so that the attachment will be directly over the hoist machine.

(b) Support ropes must be vertical for their entire length. Do not sway the scaffold nor fix the support ropes to any intermediate points to change the original path of travel.

(c) Equip the fixed end of the support rope with a proper size thimble and secure it by eye splicing or equivalent means. Braze or secure free ends to prevent fraying.

(d) For traction hoists, the support rope must be of such length that the operator can descend to the lowest point of travel without the end of the wire rope entering the hoist. Where the wire rope is inadequate for the lowest descent, make provision to prevent the hoist from running off the wire rope.

(e) For winding drum type hoists, running ends of suspension ropes must be attached by positive means to the hoisting drum so that at least four wraps of the rope will remain on the drum at all times.

(f) Support ropes must be capable of resisting chemicals or conditions to which they are exposed.

(g) Do not weld, burn, rivet, or perform open flame work on any platform suspended by fiber or synthetic rope.

(h) Do not use defective or damaged rope as lifelines or suspension lines. The repairing of wire rope is prohibited.

(4) All suspension scaffold support devices such as outrigger beams, cornice hooks, parapet clamps, or similar devices must meet the following:

(a) Be made of mild steel, wrought iron, or materials of equivalent strength.

(b) Be supported by bearing blocks.

(c) Rest on surfaces capable of supporting the reaction forces imposed by the scaffold hoist operating at its maximum rated load.

(d) Be secured against movement by tiebacks installed at right angles to the face of the building whenever possible and secured to a structurally sound portion of the building. Tiebacks must be equivalent in strength to the hoisting rope.

(5) Outrigger Beams.

(a) Outrigger beams must be made of structural metal and be restrained to prevent movement.

(b) Stabilize the inboard ends of outrigger beams by bolts or other direct connections to the floor or roof deck, or by counterweights. Do not use counterweights to stabilize mason's multiple point adjustable suspension scaffold outrigger beams.

(c) Mason's multiple point adjustable suspension scaffold connections must be designed by an RPE experienced in scaffold design.

(d) Counterweights must be made of non-flowable solid material secured to the outrigger beams by mechanical means. Do not remove until the scaffold is disassembled.

(e) Secure outrigger beams by tiebacks equivalent in strength to the suspension ropes. Secure the tiebacks to a structurally sound portion of the building or structure so that they are installed parallel to the centerline of the beam.

(f) Outrigger beams must be provided with stop bolts or shackles at both ends.

(g) When channel iron beams are used in place of I-beams, securely fasten the channels together with the flanges turned outward.

(h) Install outrigger beams so that all bearing supports are perpendicular to the beam centerline.

(i) Set and maintain outrigger beams with the web in a vertical position.

(j) Where a single outrigger beam is used, place the steel shackle or clevises with which the wire ropes are attached to the beam directly over the hoisting machines.

(6) Hoisting Machines.

(a) Hoisting machines must be of a type tested and listed by a NRTL.

(b) Each hoist must contain a name plate(s) containing the following:

(b-1) Manufacturer's name.

(b-2) Maximum load rating.

(b-3) Identification number.

(b-4) Wire rope specifications.

(c) Powered hoists must be electric-, air-, hydraulic-, or propane-powered. Gasoline-powered hoists are prohibited.

(d) All powered hoists must be equipped with speed reducers and a primary brake and a secondary brake.

(d-1) The primary brake must automatically engage whenever power is interrupted or whenever the operator ceases to apply effort.

(d-2) The secondary brake must stop and hold the hoist under over speed or abnormal conditions. All secondary brakes must be periodically tested under simulated conditions according to the manufacturer's instructions.

(e) Each powered hoist must have its own separate control.

(e-1) If the control is of the push-button type, it must be constant pressure.

(e-2) If the control is of the fixed-position type, it must have provision for automatic locking when in the off position or be guarded against accidental actuation.

(e-3) If the control is of the lever type, it may be of the constant pressure type or of the fixed-position type.

(f) Manual operation of powered hoists may be provided if the hoist is designed so that not more than one person per hoist is required to perform this operation.

(f-1) During manual operation, a means must be provided to make the prime mover inoperative.

(f-2) Provide instruction advising personnel to disconnect the power source before using a manual crank.

(g) Manually Operated Hoists.

(g-1) Provide a means to prevent rapid handle movement or fast un-spooling during manual operation. Do not place mechanisms used to allow fast un-spooling during the erection process on the scaffold.

(g-2) In the event a controlled descent device is used, it must not bypass the secondary brake.

(g-3) All winding drum hoists must be provided with a driving pawl and a locking pawl that automatically engages when the driving pawl is released.

(g-4) Gripping-type hoists must be designed so that the hoist is engaged on the suspension rope at all times, including all travel actuations of the operating lever.

(g-5) Each winding drum hoist must be provided with a positive means of attachment of the suspension hoist. The drum attachment must develop a minimum of four times the rated capacity of the hoist.

(g-6) Each hoist must require a positive crank force to descend.

(7) Working Surfaces on Suspended Scaffolds.

(a) Light metal platforms, when used, must be of a type tested and listed by an NRTL.

(b) Ladder-type platforms are prohibited.

(c) Planking.

(c-1) Planking must be composed of not less than nominal 2 inches x 10 inches (5.1 cm x 25.4 cm) unspliced planks, cleated together on the underside, starting 6 inches (15.2 cm) from each end at intervals not to exceed 4 feet (1.2 m).

(c-2) Do not extend the planking beyond the hangers more than 12 inches (30.5 cm). Securely fasten a bar or other effective means to the platform at each end to prevent its slipping off the hanger.

(c-3) The span between hangers for planked platforms must not exceed 8 feet (2.4 m).

(d) Beam platforms are prohibited.

(8) Guy, brace, guide, or equip suspended scaffolds with a tag line to prevent swaying.

(9) Two-Point Suspension Scaffolds.

(a) Two-point suspension scaffold platforms must not be less than 20 inches (50.8 cm) or more than 36 inches (91.4 cm) wide. Securely fasten the platform to the hangers by U-bolts or by other equivalent means.

(b) The hangers of two-point suspension scaffolds must be made of mild steel, or equivalent materials, having a cross sectional area capable of sustaining four times the maximum rated load and must be designed with a support for a standard railing.

(c) Securely lash two-point suspension scaffolds to the structure. Do not use window cleaner's anchors.

(d) The platform on every two-point suspension scaffold must be of the light metal or planking.

(e) Do not joint two-point suspension scaffolds by bridging.

(f) Two-point suspension scaffold platforms, when in use, must be level within 1 inch (2.5 cm) for every 1 foot (0.3 m) of platform length.

(10) Mason's Multiple-Point Adjustable Suspension Scaffolds.

(a) When employees on the scaffold are exposed to overhead hazards, provide overhead protection equivalent in strength to 2 inches (5.1 cm) planking on the scaffold not more than 9 feet (2.7 m) above the platform. The overhead protection must be laid tight and extend the entire width of the scaffold.

(b) The scaffold must be capable of sustaining a load of 50 lb/ft² (1.1 kg/m²). Do not overload.

(c) Suspend the platform by wire ropes from overhead outrigger beams.

(11) Stonesetters' multiple-point adjustable suspension scaffolds must be designed and used according to ANSI A10.8.

(12) Working Capacities.

(a) On suspension scaffolds designed for a working load of 500 lb. (226.8 kg), do not permit more than two people to work at one time.

(b) On suspension scaffolds with a working load of 750 lb. (340.2 kg), do not permit more than three people to work at one time.

g. Hanging Scaffolds. (22-8.g)

(1) Hanging scaffolds must be designed by an RPE competent in structural design.

(2) Hanging scaffold performance and components must meet or exceed those for general scaffolds and platforms according to ANSI A10.8.

(3) Hanging scaffolds must meet the following requirements:

(a) Securely fasten the scaffold to a vertical structure (for example, wall, lock gate) by hooks over a secured structural supporting member, bolt-on brackets, or other secure attachment. Attachments must be made at least every 8 feet (2.4 m). The maximum span between secure attachments is 8 feet (2.4 m). Use fasteners of adequate size to achieve design strength of scaffold.

(b) Secure the scaffold to prevent an uplift force equal to two times the weight of the scaffold and its rated load by means of hooks, brackets, or other secure attachments designed and placed to counteract uplift.

(c) The scaffold must have a secondary attachment method to secure it against falling if the primary attachment fails. This should be a flexible attachment, such as wire rope or chain, designed to withstand a minimum of five times the weight of the scaffold

and its rated load. Connect the secondary attachment to an anchor point of the same load rating or greater.

(d) The scaffold must have only one working level. Working platform decks must be slip resistant and securely attached to the scaffold frame. The maximum width, front to back, of decks is 42 inches (106.7 cm). Grating used for deck surfaces must have a maximum width opening between bars small enough to prevent the rigging components used (for example, slings, chains) from entering.

(e) Install standard guardrails systems according to chapter 21 on all open sides and ends of the platform.

(f) The scaffold must be conspicuously posted with a plate or other permanent marking that indicates the following:

(f-1) Weight of the scaffold.

(f-2) Number of personnel it was designed to support.

(f-3) Rated weight capacity.

(f-4) Specific structure(s) it was designed to be attached to – this may be a code or other form of identification when designed for a number of different structures with similar structural attachment points.

(f-5) Name of the RPE who designed the scaffold.

(f-6) Date of manufacture.

(g) Hanging scaffolds designed to also function as crane- or other LHE-supported personnel work platforms must meet the requirements of chapter 16. This includes scaffolds that require a person to stand/ride on the platform while the initial attachment to the structure is made.

(h) Position the scaffold so that the space between the platform deck edge and the face of the vertical structure is not more than 14 inches (35.6 cm). Prior to use on each jobsite application, the CP must determine if this space constitutes a hazard by being large enough to allow tools or objects to fall on workers below or, if LHE rigging may enter and entangle in the space. In these situations, close or block the space to remove the hazard.

(4) Testing according to paragraph 22-5.g.

(5) Operations.

(a) Workers must use properly selected and anchored personal fall protection when accessing and working on hanging scaffolds. Personal fall protection system components must meet the requirements of chapter 21. Do not use any part of a hanging scaffold as an anchor point for personal fall protection.

(b) Do not exceed the number of workers on the platform listed on the scaffold.

(c) Ladder must not be used on hanging scaffolds, except as a means of access from above the deck. Ladders used for access must meet the requirements of chapter 24.

(d) Hanging scaffolds must be coated or painted to minimize corrosion of the components.

(e) Store the scaffold between uses to minimize damage to the scaffold.

h. Form and Carpenter's Bracket Scaffolding. (22-8.h)

(1) Scaffolds must be constructed of wood, steel, or aluminum members with known strength characteristics and be designed to support a minimum load of 25 lbs./ft² (1.1 kg/m²).

(2) Do not permit more than two persons to occupy any given 8 feet (2.4 m) span of a bracket scaffold at any one time. Tools and materials must not exceed 75 lbs. (34 kg) in addition to person(s) occupying the area.

(3) Install a guardrail at all open sides or use another form of fall protection when a fall of 6 feet (1.8 m) or greater exists or, when other hazards exist below the platform (see chapter 21).

(4) Construct figure-four scaffolds as follows:

(a) Construct the scaffold from sound lumber. Do not exceed spacing of more than 8 feet (2.4 m) on center.

(b) Install a bracket ledger consisting of two pieces of 1 inch x 6 inches (2.5 cm x 15.2 cm) or heavier material nailed on opposite sides of the vertical form support. Install the ledgers so that they do not project more than 3.5 feet (1.1 m) from the outside of the form support. Securely brace and attach the ledger to prevent tipping or turning.

(c) Intersect the knee or angle brace and the ledger at least 3 feet (0.9 m) from the form at an angle of approximately 45 degrees. Nail the lower end to a vertical support.

(d) Construct the platform with two or more scaffold planks that extend at least 6 inches (15.2 cm) beyond the ledgers at each end unless secured to the ledgers. When planks are secured to the ledgers (nailed or bolted), use a wood filler strip between the ledgers. Limit unsupported projecting ends of planks to an overhang of not more than 12 inches (30.5 cm).

(e) Do not exceed the maximum permissible spans of planking according to ANSI A10.8. Span lengths must be consistent with allowable bearer loads.

(5) Metal brackets or scaffold jacks that are an integral part of the form must be securely bolted or welded to the form. Folding-type brackets must be either bolted or secured with a locking-type pin when extended for use.

(6) Clip-on or hook-over brackets may be used on form work provided the form walers are bolted to the form or secured by snap ties or tie-bolts extending through the form and securely anchored. In addition, carpenter bracket scaffolds may be attached by any of the following:

(a) A bolt extending through to the opposite side of the structural wall.

(b) A metal stud attachment device.

(c) Welding.

(d) Hooking over a secured structural supporting member.

(7) Metal brackets must not be spaced more than 8 feet (2.4 m) on centers.

(8) Either bolt scaffold planks to the metal brackets or install of such length that they overlap the brackets at each end by at least 6 inches (15.2 cm). Limit unsupported projecting ends of scaffold planks to a maximum overhang of 12 inches (30.5 cm).

(9) Limit the maximum permissible spans for planking consistent with allowable bearer loads.

(10) Bolt or secure folding-type metal brackets, when extended for use, with a locking-type pin.

(11) Design wooden bracket form scaffolds according to tables 22-1 and 22-2 so that they are an integral part of the form panel.

(12) Brackets must consist of a triangular shaped frame made of wood with a cross-section not less than 2 inches x 3 inches (5.1 cm x 7.6 cm) or of 1¼ inches x 1¼ inches x ⅛ inch (3.2 cm x 3.2 cm x 0.3 cm) structural angle iron.

(13) Design wooden scaffolds criteria according to tables 22-1 and 22-2

(14) Either nail or bolt scaffold planks to the runners or install so that they overlap the ledgers at each end by at least 6 inches (15.2 cm). Limit unsupported projecting ends of scaffold planks to a maximum overhang of 12 inches (30.5 cm).

(15) Limit the maximum permissible spans for planking consistent with allowable bearer loads.

i. Horse Scaffolds. (22-8.i)

(1) Do not construct or arrange horses more than two tiers or 10 feet (3 m) in height. Scaffolds must be 5 feet (1.5 m) or less in height and 5 feet (1.5 m) or more in width. When tiered heights exceed 6 feet (1.8 m), fall protection must be used. (See chapter 21)

(2) Construct horse scaffolds according to table 22-3, at minimum.

(3) Do not space the horse scaffolds more than 5 feet (1.5 m) for medium duty and not more than 8 feet (2.4 m) for light duty.

(4) When arranged in tiers, place each horse scaffold directly over the horse scaffold in the tier below. Nail or otherwise secure the legs to the planks to prevent displacement or thrust and cross brace each tier.

(5) Do not use weakened or defective components.

j. Pump Jack Scaffolds. (22-8.j)

(1) Pump jack scaffolds must be designed for a minimum working load of 500 lbs. (226.8 kg). Do not permit more than two persons on the scaffold at one time.

(2) Pump jack brackets, braces, and accessories must be fabricated from metal plates and angles and installed according to the manufacturer's instructions. Installation and operational manuals must be maintained onsite and made available upon request of the local SOHO/USACE supervisor/KO or COR.

(3) Fully deck and secure the planking on the standing platform. Do not overlap platforms thicker than 2 inches (5.1 cm).

(4) Construct the standing platform to be at least 18 inches (45.7 cm) wide and the work bench at least 12 inches (30.5 cm) wide.

(5) Secure all materials on the work bench from falling.

(6) Install a guardrail system on pump jack scaffolds according to the manufacturer's instructions. PFAS may be used in lieu of guardrails. See chapter 21 for personal fall arrest system requirements.

(7) When a workbench is used at an approximate height of 42 inches (106.7 cm), the top rail of the guardrail system may be eliminated if the workbench is fully decked, secured, and is capable of withstanding 200 lbs. (90.7 kg) force in any direction.

(8) Do not use workbenches as a standing platform.

(9) Provide a ladder for access to the platform.

(10) Support all poles by sills or other foundations adequate to support the load.

(11) Poles.

(a) Pole lumber must be 2 inches x 4 inches (5.1 cm x 10.2 cm) stock of Douglas fir, or equivalent, straight-grained, clear, free of cross-grain, shakes, large loose or dead knots, and other defects that might impair strength.

(b) Wood poles must not exceed 30 feet (9.1 m) in height.

(c) Wood pole spacing must not exceed 7 feet (2.1 m).

(d) Metal poles must not exceed 50 feet (15.2 m) in height unless the design is approved by an RPE.

(e) The spacing of metal poles must not exceed 7 feet (2.1 m) unless determined acceptable by an RPE.

(f) When poles are constructed of two continuous lengths, they must be of 2 inches x 4 inches (5.1 cm x 10.2 cm) (kiln dried straight grain fir) or equivalent, spiked together with the seam parallel to the pump jack, and with 10d common nails, 12 inches (30.5 cm) center-to-center, staggered uniformly from opposite outside edges.

(g) Do not splice 4 inches x 4 inches (10.2 cm by 10.2 cm) wood poles to increase the length of any individual member.

(h) Secure poles to the wall by triangular bracing, or equivalent, at the bottom, top, and other points to provide a maximum vertical spacing of not more than 10 feet (3 m) between braces. Each brace must be capable of supporting a minimum of 225 lbs. (102.1 kg) tension or compression.

(i) When wood scaffold planks are used as platforms, do not space the poles used for pump jacks more than 10 feet (3 m) on center. When fabricated platforms are used that comply with all other provisions of paragraph 22-8.j pole spacing may exceed 10 feet (3 m) on center if permitted by the manufacturer.

(j) Do not place poles within 10 feet (3 m) of power lines or electrical conductors until such are insulated, de-energized, or otherwise rendered safe against contact (see chapter 11).

(12) Brackets.

(a) Each pump jack bracket must have two positive gripping mechanisms to prevent any failure or slippage.

(b) For the pump jack bracket to pass bracing already installed, use an extra brace approximately 4 feet (1.2 m) above the one to be passed until the original brace is reinstalled.

k. Adjustable Scaffolds. (22-8.k)

(1) Design and construct adjustable scaffolds according to ANSI A10.8.

(2) Maintain a copy of the user's manual onsite at all times.

(3) Secure adjustable scaffolds to the structure according to the manufacturer's user manual.

(4) Safe Access.

(a) If portable ladders are used, they must be removed every time the platform is raised, lowered, or repositioned to ensure that the 4:1 ratio is maintained. Secure the ladder to prevent movement. (See chapter 24)

(b) When stair towers are used for access to adjustable scaffolds, the difference between the two elevations must be 2 feet (0.6 m) or less.

(c) An SRL, if allowed by the manufacturer, can be used to provide fall protection when climbing the tower (see chapter 21).

(d) On towers over 20 feet (6.1 m), provide rest platforms at least every 20 feet (6.1 m).

(5) Level the adjustable scaffold by using leveling jacks.

(6) When bridges are used on a single tower, do so only in strict compliance with the manufacturer's instructions.

(7) Ratchet driven winding drum hoist must be equipped with a driving pawl and a locking pawl. The locking pawl must automatically engage when the driving pawl is released.

(8) All crank-driven winding drum hoists must employ a positively actuated locking pawl that engages the drive train of the hoist and is actuated by reverse descending movement of the crank handle. This mechanism must not be rendered inoperative by outside contamination.

(9) Every winding drum must contain at least three wraps of the suspension wire rope at the lowest point of hoist travel.

(10) Each hoist must be provided with positive wire rope attachments. Wire rope attachments must develop a minimum of 80% of the wire rope breaking strength.

(11) Terminate wire rope according to the manufacturer's instructions. Do not use U-type wire rope clips as a wire rope termination method.

(12) The wire rope must be capable of supporting at least six times the scaffold's design load.

I. Load Handling Equipment (LHE) – Supported Personnel. Supported Personnel Work Platforms. See chapter 16 and 29 CFR 1926 Subpart CC. (22-8.l)

m. Mobile Elevating Work Platforms (MEWP). (22-8.m)

(1) All MEWPs must be designed and constructed according to ANSI, as appropriate.

(2) Operate, inspect, and maintain MEWPs according to the manufacturer's instructions.

(3) Maintain records of inspections conducted while the unit is at the work.

(4) Maintain a height-to-base width ratio of the scaffold during movement of 2:1 or less, according to the manufacturer's instructions.

(5) Maintain the elevating MEWPs manufacturer's operating manual readily available on the equipment.

(6) Do not operate MEWPs until the access door or chains are in the closed position.

(7) Use fall protection according to chapter 21 of this manual.

(8) Climbing of the rails is prohibited.

(9) All boom-supported MEWPs must be equipped with an alarm, or other suitable warning device, at the platform. The alarm must be in operable condition and must

automatically activate when the machine base is more than 5° out of level in any direction.

(10) Do not use MEWPs for work on energized electrical wiring and/or equipment.

(11) Only operate MEWPs from the ground position in an emergency (rescue), for maintenance, or when unoccupied.

(12) Lift controls must be located below the guardrail height. When lift controls are not located below the guardrail height, install an aftermarket guard.

n. Vehicle-Mounted Elevating and Rotating Work Platforms (Aerial Devices/Lifts). (22-8.n)

(1) Vehicle-mounted elevating and rotating work platforms (aerial lifts, to include articulating boom platforms/lifts (knuckle boom lifts), trailer-mounted boom lifts) must be designed and constructed according to ANSI/SAIA A92.2.

(2) Operate, inspect, test, and maintain vehicle-mounted elevating and rotating work platforms according to the manufacturer's instructions.

(a) Vehicle-mounted elevating and rotating work platforms must also comply with requirements in chapters 21 and 18.

(b) Maintain records of inspections conducted while the unit is at the work site.

(c) Maintain the aerial device's manufacturer's operating manual readily available in or on the vehicle.

(d) If the unit is considered rated, and used as an insulating device, maintain copies of the electrical insulating components and system tests conducted while the unit is at the work site.

(e) All required safety decals, labels, and signs must be in place and legible.

(3) Transporting.

(a) Do not move aerial lift trucks, to include cherry pickers, when the boom is elevated in a working position with personnel in the basket except for equipment that is specifically designed for this type of operation. When manufacturers allow mobile operation, the work site must be inspected for the following before movement occurs:

(a-1) Untamped earth fills (soft ground).

(a-2) Ditches.

- (a-3) Drop-offs and floor obstructions.
- (a-4) Debris.
- (a-5) Overhead obstructions and electrical conductors.
- (a-6) Weather conditions.
- (a-7) The presence of unauthorized persons.

(b) Before moving an aerial lift, inspect the boom(s) to see that it is properly cradled and outriggers are in stowed positions, except as provided in paragraph 22-8.n(3) above.

(c) Secure aerial ladders in the lower traveling position by the locking device on top of the truck cab and the manually operated device at the base of the ladder before the truck is moved for highway travel.

(4) Operating Practices.

(a) Follow the manufacturer's instructions for control station operation (for example, primary versus secondary, upper versus lower).

(b) Set the brakes and position outriggers, when used, on pads or a solid surface.

(c) Install wheel chocks before using an aerial lift on an incline.

(d) Test lift controls each day prior to use to ensure safe working condition.

(e) Lift controls must be located below the guardrail height. When lift controls are not located below the guardrail height, install an after-market guard.

(f) Do not exceed boom and basket load limits specified by manufacturer.

(g) Articulating boom and extensible boom platforms, primarily designed as personnel carriers, must have both platform (upper) and lower controls.

(g-1) Upper controls must be in or beside the platform within easy reach of the operator.

(g-2) Lower controls must provide for overriding the upper controls.

(g-3) Controls must be plainly marked as to their function.

(h) Do not wear climbers (spikes) while performing work from an aerial lift.

(i) Do not alter in any manner the insulated portion of an aerial lift that might reduce its insulating value.

(j) Occupants must always stand firmly on the floor of the basket and must not sit or climb on the edge of the basket or use planks, ladders, or other devices for a work position.

o. Mast Climbing Work Platforms (MCWP). (22-8.o)

(1) Erect, use, inspect, test, maintain, and repair MCWPs according to ANSI A92.9, International Powered Access Federation (IPAF)/SAIA, and the manufacturer's instructions.

(2) Conduct a pre-use inspection prior to erecting the work platform according IPAF/SAIA and the manufacturer's instructions.

(a) Conduct an overhead inspection to ensure that the MCWP will not come in contact with any obstructions while moving up or down the mast. Give special attention to high voltage conductors. Once the voltage of the line(s) is established, adhere to the minimum safe approach distances in table 11-4.

(b) Conduct an inspection of the ground to ensure that there are no obstacles around the MCWP and in the path of travel (if the unit is on a mobile chassis) such as holes, drop-offs, debris, ditches, or soft fill. For static and mobile units, compaction will be sufficient to support the static and live loads for the configuration. The perimeter around the base of the unit, matching the length and width of the platform area above, must be identified as restricted access by use of danger signs, tape, fences, or other suitable means.

(c) Daily maintenance and inspections must be performed and documented by a CP according to paragraph 22-5.d.

(3) Only designated and trained users can operate the MCWP. Training records must be maintained for at least three years and maintained onsite. All personnel on the MCWP must be trained according to paragraph 22-3.

(4) Do not raise the MCWP on uneven or sloped surfaces unless outriggers are used to level the MCWP and the ground is suitable to support the load.

(5) Raise the MCWPs according to the manufacturer's recommended free-standing height and outrigger requirement and loading recommendations. Use

outriggers according to the manufacturer's recommendations. The unit must be level before raising the platform (mast should be plumb and level before vertical movement of platform).

Note. Not all MCWPs are designed with freestanding capability. Check the machine and manual to see if the machine being operated has a freestanding height.

(6) If the unit is on a powered chassis, lower the MCWP to its lowest position prior to being moved. Additionally, move all material and tools from the platform, fully extend and open the outriggers and raise the jacks no more than 1 inch (2.5 cm) from the ground. When moved into its new working position, the unit must be set up and leveled again before it is elevated. The work platform must remain horizontal within 2 degrees during normal movement of the platform.

(7) Do not drive a MCWP with the platform elevated or personnel on the platform. Follow the manufacturer's instructions when moving a MCWP to determine the safe mast height for ground conditions, ground slope, and overhead obstructions.

(8) Tie MCWPs to the building (or structure) according to manufacturer's instructions unless it is designed to be freestanding. A QP must demonstrate the correct anchoring method based on tensile, shear, and torsion forces according to the manufacturer's instructions and with respect to the strength of the structure to be tied to, following all relevant requirements on installation from the anchor manufacturer's data.

(9) Do not use ladders or structures of any kind to increase the size or working height of platform unless specifically designed by the manufacturer for the intended use and all fall hazards have been controlled.

(10) Access.

(a) Climbing of braces and guardrails is prohibited. When access ladders, including masts designed as ladders, exceed 20 feet (6.1 m) in height, use fall protection. (See chapter 21)

(b) All access gates must either close automatically or be electronically interlocked to prevent operation of the MCWP unless they are closed. Do not use chains or ropes as access gates.

(c) Prior to use at elevations of 20 feet (6.1 m) or more, develop an emergency egress plan to evacuate workers from a MCWP that gets caught in an elevated position 20 feet (6.1 m) or more above the ground. If that plan includes descending the mast, all employees working on the MCWP must be provided fall arrest equipment and must be trained in its use. (See chapter 21)

(11) Do not raise the MCWP in windy or gusty conditions.

(a) Follow the manufacturer's instructions to determine maximum in-service wind speed conditions. A copy of the operator's manual must be available on the jobsite.

(b) Account for loads and forces according to the manufacturer's instructions.

(12) Do not alter or modify in any way MCWPs unless approved by the manufacturer and performed by a QP.

(13) Do not use damaged or malfunctioning machines. Discontinue operation of damaged equipment until the unit is repaired.

(14) MCWPs must be equipped with a permanently installed device on the work platform to switch off the work platform and secure it from unauthorized use.

(15) Planking and decking must meet paragraph 22-8.c and 29 CFR 1926.451.

(16) Guarding

(a) All open sides of the platform must be equipped with a guardrail which can be securely fastened in place. Secure guardrails according to the manufacturer's instructions. Guardrails must be able to withstand, without failure, a force of 300 lbs. (136.1 kg), applied in any outward or downward direction.

(b) If the MCWP is erected towards a wall and the distance is more than 14 inches (35.6 cm), a guardrail is required. The maximum distance between wall and platform may increase to 18 inches (45.7 cm) for plastering and lathing operations. When the horizontal distance between the wall and platform is less than 14 inches (35.6 cm), then a guardrail is not required.

(c) Any MCWP with a travel speed of more than 15 fpm (4.6 m/min) must include a mast guard around at least three sides of the mast. The guard must provide protection from not more than 1 inch (2.5 cm) above the platform floor to a minimum height of 6.5 feet (1.8 m) above the platform floor and will have no opening larger than 1 in² (2.5 cm²). (See ANSI A92.9)

p. Roofing Bracket Scaffolds (see 29 CFR 1926.452). (22-8.p)

q. Stilts (see 29 CFR 1926.452). (22-8.q)

r. Turbine Maintenance Platforms (TMPs). (22-8.r)

(1) Design.

(a) TMPs must be designed and/or certified by an RPE. Existing TMPs must be certified prior to the next use. There is a grace period of 6 months from the effective date of this manual.

(b) TMPs must be designed to support their own weight plus four times the maximum intended load.

(c) A data plate must be attached or the documentation showing the design must be readily available onsite. The RPE must be listed on the drawings and calculations for the platform, not on the data plate. The data plate, when used, must include the following:

(c-1) Descriptive name indicating intended usage.

(c-2) Assembled weight of TMP.

(c-3) Total maximum live load (pounds).

(c-4) Total maximum distributed live load (pounds per square foot).

(c-5) Date of fabrication.

(c-6) Name of fabricator.

(c-7) Any load restrictions or usage limitations.

(d) If wire rope is used to either support the platform after installation or to raise the platform while occupied, the wire rope must have a safety factor of six.

(e) Deflections in structural members and structural systems under appropriate service load combinations must not impair the serviceability of the structure.

(f) If hooks are used to support the platform in its final position, they must be designed with a positive means of securing them to prevent the hooks from being disengaged.

(g) The decking/platform must be designed so that the space between adjacent obstacles or structures and the space between the platform is no more than 9.5 inches (24.1 cm) wide, except where the user can demonstrate that a wider space is necessary. Where gaps exceed 9.5 inches (24.1 cm), implement fall protection according to chapter 21.

(h) Working surfaces must be slip-resistant.

(2) Testing. Immediately after fabrication and after any modification of the structural members, the platform must be proof tested to 100% of its rated capacity according to paragraph 22-5.e.

(3) Assembly/Disassembly.

(a) The TMP must be positively attached prior to use. Platform components must be supported and secured such that each component is stable in all anticipated load conditions. When attachment points are welded, they must be either welded by an AWS certified welder or a pull test conducted according to RPE specifications. See chapter 10 for structural welding requirements and qualifications.

(b) Raising and lowering the platform, when occupied by personnel, will only be done with rated grip hoists or other lifting equipment rated for lifting personnel. Do not use chain falls to lift personnel unless an independent fall protection system is used. (See chapter 21)

s. Forklift/Powered Industrial Truck (PIT) – Mounted Work Platforms. (22-8.s)

(1) Do not use forklifts/PITs to support work platforms unless there is no other practical method. If a rough terrain (RT) forklift must be used, all the conditions must be met.

(2) The manufacturer must specifically allow the specific machine to lift personnel. Maintain the operator's manual at the work site on the forklift.

(3) Maintain the manufacturer's specifications onsite. These specifications must reference ANSI B56.6.

(a) A data plate may be used in lieu of the manufacturer's specifications if it references ANSI B56.6.

(b) If the platform is not manufactured by or for the company that manufactures the forklift, a letter must be obtained from the forklift manufacturer that states the machine is compatible with the platform design. This letter must be kept onsite and a copy provided to the USACE supervisor/KO or COR.

(4) Securely attach the platform to the lifting carriage and forks.

(5) Secure the lifting carriage and forks from pivoting forward.

(6) If the truck is equipped with a rotator, deactivate the rotator.

- (7) Provide personnel protection from moving parts while in their normal working positions.
- (8) Provide overhead protection as necessary for the operating conditions.
- (9) The lifting operation must be done smoothly throughout the entire range of the lift.
- (10) All lift limiting devices and latches, if so equipped, must be functional.
- (11) The operator must verify a firm footing before lifting personnel.
- (12) All personnel must use a fall restraint system according to chapter 21 and must maintain a firm footing on the platform at all times.
- (13) Do not tilt the platform forward or rearward.
- (14) Lower the platform to the ground level for personnel to enter and exit.
- (15) The operator must remain at the controls whenever personnel are elevated.
- (16) Do not move the forklift horizontally while occupied.
- (17) Before elevating personnel, forklift travel controls must be in neutral and the parking brake set.
- (18) The operator must verify that the mast or boom travel is vertical and must not operate on a slope unless the RT forklift is level.
- (19) The operator must verify that the path of the platform travel is clear of hazards, such as electrical wires, overhead obstructions, scaffolding, storage racks, and other obstacles.
- (20) Before elevating personnel, the work area must be marked to warn of work by elevated personnel.
- (21) Driving a forklift equipped with a personnel work platform in a raised position or with personnel on the platform is forbidden.
- (22) Before raising or lowering the platform, the operator must alert the personnel on the platform and then move the platform smoothly and with caution as requested by the occupants.
- (23) The combined weight of the platform, load, and personnel must not exceed one-third of the capacity at the related load center position as indicated on the information plate(s) of the RT forklift truck.

t. Work Stands (Portable Work Platforms). (22-8.t)

(1) Work stands must be designed according to either ANSI A14.2 (aluminum) or ANSI A14.5 (plastic/fiberglass).

(2) The working height of work stands must not exceed 4 feet (1.2 m).

(3) The load rating must be clearly and legibly marked on the work stand. Do not load the work stand beyond the manufacturer's rated capacity. The maximum intended load includes the worker and all tools and supplies.

(4) When work stands are used adjacent to stairs or ramps where a fall to a different level could occur, use guardrails or another other fall protection method. See chapter 21 for fall protection requirements and options.

(5) Inspect work stands for visible defects on a daily basis. Maintain work stands so they remain free of structural damage.

(6) Do not use job-built work stands. Do not use sawhorses as work stands.

u. Trestle Ladder Scaffolds. (22-8.u)

(1) Do not place scaffold platforms higher than the second-highest rung or step of the ladder supporting the platform.

(2) All ladders used in step, platform, and trestle ladder scaffolds must:

(a) Meet or exceed 29 CFR 1926 Subpart L.

Note. Job-made ladders are not permitted.

(b) Place, fasten, or equip the ladder to prevent slipping.

(3) Do not bridge scaffolds one to another.

(4) Climbing and Working Locations. Climb or work with the body near the middle of the step or rung. Climbing higher than the step or rung indicated on the label marking the highest standing level of a ladder. Do not step or stand on any of the following:

(a) A ladder top cap or the top step of the step or trestle ladder or the bucket or pail shelf of a self-supporting ladder.

(b) The rear braces of a self-supporting ladder, unless designed and recommended for that purpose by the manufacturer.

(c) The top step of the extension section of an extension trestle ladder.

(d) The top cap or top step of a combination ladder when it is used as a self-supporting ladder.

22-9. Figures and Tables.

**Table 22-1
Form Scaffolds - Minimum Design Criteria for Wooden Bracket Form Scaffolds**

Members	Dimensions
Bracket uprights	2 x 4 inches or 2 x 6 inches (5.1 x 10.2 cm or 5.1 x 15.2 cm)
Bracket support ledgers	2 x 6 inches (5.1 x 15.2 cm)
Maximum bracket width	3 feet 6 inches (1.1 m)
Bracket braces	1 x 6 inches (2.5 x 15.2 cm)
Guardrail post	2 x 4 inches (5.1 x 10.2 cm)
Guardrail height	36 to 45 inches (91.4 to 114.3 cm)
Midrail	1 x 6 inches (2.5 x 15.2 cm)
Toeboards	1 x 6 inches (2.5 x 15.2 cm)
Bracket upright spacing	8 feet (2.4 m) (on centers)

**Table 22-2
Form Scaffolds - Minimum Design Criteria for Light-Duty Figure-Four Form Scaffolds**

Members	Dimensions
Bracket uprights	2 x 4 inches or 2 x 6 inches (5.1 x 10.2 cm or 5.1 x 15.2 cm)
Bracket outrigger ledgers	(2) 1 x 6 inches (2.5 x 15.2 cm)
Bracket braces	(2) 1 x 6 inches (2.5 x 15.2 cm)
Maximum length of ledgers	3 feet 6 inches (1.1 m) (unsupported)
Bracket upright spacing	8 feet (2.4 m) (on centers)

**Table 22-3
Minimum Dimensions for Horse Scaffold Members**

Members	Dimensions
Horizontal members of bearers	3 x 3.9 inches (7.6 x 10 cm)
Legs	2 x 3.9 inches (5.1 x 10 cm)
Longitudinal brace between legs	1 x 5.9 inches (2.5 x 15 cm)
Gusset brace at top of legs	1 x 7.9 inches (2.5 x 20.1 cm)
Half diagonal braces	2 x 3.9 inches (5 x 10 cm)

22-10. Checklists and Forms.

Not Applicable.

Chapter 23

Rope Access

This chapter applies to industrial rope access when utilized as a means of working at height, typically using a two-rope system and associated equipment, to gain access to, be supported at, and/or as a means of egress from structures, either man-made or natural. It applies to cases where ropes are used as the primary means of support and/or primary means of positioning whereas workers descend or ascend on a rope or traverse along a tensioned rope where the use of hands and feet can no longer be used to fully support the body in order to perform a primary function, such as inspection or maintenance.

Note. This chapter is not intended to apply where rope is utilized for technical rescue techniques by emergency first responders or where only a single rope is used for support without a backup system such as used in tree maintenance.

Note. This chapter does not apply to other methods of working at height that are not specifically described above as industrial rope access, such as steeple jacking, suspended scaffolds, steelwork erection, boatswain's chairs or "rope descent systems" as defined by 29 CFR 1910.21.

23-1. References.

- a. ANSI/ASSP Z359, The Fall Protection Code (<https://www.assp.org/standards>) (23-1.a)
- b. ANSI/ISEA Z89.1, American National Standard for Industrial Head Protection (<https://webstore.ansi.org/>) (23-1.b)
- c. ANSI Z459.1, Safety Requirements for Rope Access Systems (<https://webstore.ansi.org/>) (23-1.c)
- d. ASTM E2505, Standard Practice for Industrial Rope Access (<https://www.astm.org/Standard/standards-and-publications.html>) (23-1.d)
- e. Cordage Institute (CI) 1800, Test Methods for Life Safety Rope and Accessory Cords for Life Safety Applications (<https://ropecord.com/publications-catalog/>) (23-1.e)
- f. CI 1801, Performance Requirements for Low Stretch and Static Life Safety Rope (<https://ropecord.com/publications-catalog/>) (23-1.f)
- g. ISO 22846-2, Personal Equipment for Protection Against Falls- Rope Access Systems- Part 2: Code of Practice (<https://www.iso.org/standards.html>) (23-1.g)

23-2. Definitions.

a. Rope Access. A variety of advanced access techniques where ropes and specialized equipment are used as the primary method for providing access and support to workers in their jobs at high or hard-to-reach places. (23-2.a)

b. Rope Access Lead Technician/Competent Person (CP) for Rope Access. An experienced Rope Access Technician who has completed training and certification to identify, evaluate, and address existing and potential hazards involved with rope access, including fall protection and rescue, and who has the employer's authority to take prompt corrective action with regard to such hazards. The Rope Access Lead Technician/CP for Rope Access must work under the direct supervision of a Rope Access Supervisor/Qualified Person (QP) for Rope Access. (23-2.b)

c. Rope Access Supervisor/Qualified Person (QP) for Rope Access. An experienced Rope Access Technician with extensive practical experience and has completed training and certification to perform complex rigging, advanced rescue, and advanced rope access skills. The Rope Access Supervisor/QP for Rope Access is responsible for the entire rope access work site, including management and oversight of Rope Access Technicians on the work site and designing, analyzing, evaluating, and specifying the rope access work systems. They must have knowledge and experience to direct rescue operations from rope access systems and be able to perform advanced rescue from rope access systems. (23-2.c)

d. Rope Access Technician/Authorized Technician. An individual who has completed training and certification to perform standard rope access operations including operating ascent and descent systems, using fall protection, and have the skills necessary to perform limited rescue from rope access systems. They may only work under the direct supervision of a Rope Access Lead Technician/CP for Rope Access or Rope Access Supervisor/QP for Rope Access. (23-2.d)

23-3. Personnel Required Qualification/Training.

a. Rope Access Supervisor/QP for Rope Access. As a minimum, Rope Access Supervisor/QP for Rope Access must meet and possess documentation of certification/training requirements for a Rope Access Supervisor/QP (for example, advanced, level 3) for Rope Access according to current industry standards for rope access (for example, ANSI Z459.1, ISO 22846-2, ASTM E2505). (23-3.a)

b. Rope Access Lead Technician/Competent Person (CP) for Rope Access. As a minimum, Rope Access Lead Technicians/Competent Persons for Rope Access must meet and possess documentation of certification/training requirements for a Rope Access Lead Technician/Competent Person (for example, intermediate, level 2) for Rope Access according to current industry standards for rope access (for example, ANSI Z459.1, ISO 22846-2, ASTM E2505). (23-3.b)

c. Rope Access Technician/Authorized Technician. All persons performing rope access must at least meet the qualifications/training as a Rope Access Technician/Authorized Technician. As a minimum, Rope Access Technicians must meet and possess documentation of certification/training requirements of a Rope Access Technician/Authorized Technician (for example, basic, level 1) according to current industry standards for rope access (for example, ANSI Z459.1, ISO 22846-2, ASTM E2505) in addition to the following: (23-3.c)

(1) Have a working understanding of the Rope Access Work Plan (see para 23-7) and all applicable policy and procedures.

(2) Be capable of identifying work zones and preparing JHAs.

(3) Be familiar with rescue procedures and systems used.

d. In addition to initial and recertification requirements according to current industry standards for rope access, provide refresher training for all rope access personnel at least every two years, or when there are changes in procedures, equipment, or conditions that render previous training obsolete, or there are inadequacies in performance that indicates a lack of knowledge or skill. (23-3.d)

e. All rope access personnel that use personal fall protection equipment must have training in fall protection, at minimum, as an Authorized Person according to chapter 21. (23-3.e)

f. All rope access personnel must be at least 18 years of age. (23-3.f)

g. All employees conducting rope access work must be physically and medically qualified for performing the duties to which they are assigned. (23-3.g)

23-4. Roles and Responsibilities.

a. Rope Access Supervisor/QP for Rope Access. The Rope Access Supervisor/QP for Rope Access is responsible for the entire rope access work site to include the following: (23-4.a)

(1) Responsible for the development, implementation, and management of the Rope Access Work Plan (see para 23-7).

(2) Supervise rope access work activities and Rope Access Technicians to ensure compliance with the Rope Access Work Plan (see para 23-7).

(3) Design, evaluate, and specify rope access equipment to be used.

(4) Inspect rope access equipment (see para 23-5.b).

b. Rope Access Lead Technician/Competent Person (CP) for Rope Access. (23-4.b)

(1) Perform rope access work according to the Rope Access Work Plan and as directed by the Rope Access Supervisor/QP for Rope Access (see para 23-7).

(2) Identify hazards and take corrective measures to eliminate or control them to an acceptable level. Stop work if conditions are unsafe to proceed.

(3) Properly use, inspect, and maintain rope access equipment, tools, and PPE (see para 23-5.b).

(4) Perform and/or assist in rescue according to the rescue procedures in the Rope Access Plan (see para 23-7).

c. Rope Access Technician/Authorized Technician. (23-4.c)

(1) Perform rope access work according to the Rope Access Work Plan and as directed by the Rope Access Supervisor/QP for Rope Access or Rope Access Lead Technician/CP for Rope Access (see para 23-7).

(2) Adjust, inspect, maintain, care for, and properly store rope access equipment, tools, and PPE.

(3) Inspect and verify the integrity of anchor systems and components.

(4) Recognize work site hazards and notify the Rope Access Supervisor/QP for Rope Access of any such hazard.

(5) Understand and communicate any written or verbal warnings.

(6) Perform and/or assist in rescue according to the rescue procedures in the Rope Access Plan (see para 23-7).

(7) Utilize appropriate PPE as designated by the Rope Access Supervisor/QP for Rope Access.

23-5. Inspection Requirements.

a. Inspect all equipment prior to each use and maintain and use it according to the manufacturer's instructions. (23-5.a)

b. A Rope Access Supervisor/Rope Qualified Person (QP) for Rope Access or a Rope Access Lead Technician/CP for Rope Access must inspect equipment at least annually according to the manufacturer's instructions. Document the inspections. (23-5.b)

23-6. Activity Hazard Analysis (AHA) Requirements.

Develop AHAs according to paragraphs 1-6 or 2-6, as applicable, and submit as part of the Rope Access Work Plan (see para 23-7). The AHA must include the work methods to be used to include rope access systems, equipment, anchor points, and other materials, tools, and PPE, along with the controls used to eliminate or control the hazards to an acceptable level.

23-7. Minimum Plan Requirements.

A Rope Access Work Plan is required when rope access is performed. A Rope Access Supervisor/QP for Rope Access must develop the plan and accompanying procedures and submit to the USACE supervisor for approval or to the KO or COR for acceptance. The plan must be maintained at the work site and accessible to all affected persons. The plan must include the following:

- a. Detailed description of activity being performed. (23-7.a)
- b. Assignment of personnel and their roles and responsibilities, to include identification of a Rope Access Supervisor/QP for Rope Access or Rope Access Lead Technician(s)/Competent Person(s) for Rope Access responsible for direct supervision of rope access work. Include necessary information/documentation to support qualification/training of such persons. (See para 23-3) (23-7.b)
- c. Consideration of the various rope access alternatives and their respective access advantages and hazards. (23-7.c)
- d. Procedures for communication and coordination with the USACE supervisor/KO or COR regarding rope access safety and rescue procedures. (23-7.d)
- e. An AHA developed according to paragraph 23-6. (23-7.e)
- f. Rescue procedure and methods for prompt rescue (for example, self-rescue, assisted rescue, emergency service rescue, communication, rescue equipment). (23-7.f)
- g. Inspection and oversight methods to ensure adherence to the plan. (23-7.g)

23-8. General Requirements.

- a. Work Teams. (23-8.a)
 - (1) Rope access work teams must consist of a minimum of two Rope Access Technicians.
 - (2) Designate at least one member of the work team as the Rope Access Supervisor/QP for Rope Access and/or Rope Access Lead Technician/CP for Rope

Access. Either a Rope Access Supervisor/QP for Rope Access or Rope Access Lead Technician/CP for Rope Access must be present and directly supervise all rope access activities.

(3) A Rope Access Supervisor/QP for Rope Access worker may supervise no more than six workers (for example, Rope Access Lead Technician/CP for Rope Access or Rope Access Technician/Authorized Technician) at any time.

b. Rope Access Equipment. Equipment and components selected to be use as part of a rope access system must be compatible, be used according to the equipment manufacturer's instructions, and meet equipment requirements contained in current applicable nationally recognized standards (for example, ANSI Z459.1, ASTM E2505, ISO 22846-2, ANSI Z359). (23-8.b)

(1) Anchorages. A Rope Access Supervisor/QP for Rope Access or Rope Access Lead Technician/CP for Rope Access must identify independent anchorage systems for main and backup systems. Anchorage systems must have a minimum strength of 5,000 pounds (22.3 kN) or two times the maximum arrest force per system attached.

(2) Ropes. Ropes used as working line or safety line must be tested according to CI 1800/1801 and be made of synthetic fiber with a nominal breaking strength of at least 5,000 pounds (22.3 kN) when new. The working lines and safety lines must be specifically designed and intended for life safety use. Additionally, elasticity (elongation) of lines may not be greater than 10% with a load of 1,800 pounds (8kN) applied.

(a) To aid in drying when stored, coil and pile ropes or suspend them so that air can circulate through the coils.

(b) Do not use wet ropes for electrical work.

(c) Do not splice climbing ropes to effect repair.

(3) Carabiners and Snaphooks. When used for climbing (life support), carabiners and snaphooks must require at least two consecutive and deliberate actions to open the gate. They must also be rated at 5,000 pounds (22.3 kN) and meet the ANSI Z359 requirements. Gates must be rated at 3,600 pounds (16 kN). Carabiners and snaphooks must be self-closing and self-locking. To prevent rope fraying, the use of rope thimbles is recommended when attaching rope snaps.

(4) Pulleys/Rope Sleeves. Anti-friction devices (for example, pulleys, rope sleeves) are recommended to prevent rope damage.

(5) Climbers PPE. Utilize appropriate footwear, long pants, work shirt with a minimum 4 inches (10.2 cm) sleeve length, eye protection, ANSI Z89.1 approved vented or non-vented climbers' helmet with at least a 3-point retention system, and gloves. When the air temperature exceeds 85°F (29°C), climbers should carry a water

supply with them. Other PPE (for example, hearing protection, face shields, dust masks, respirators) may be required depending on specific hazards or environmental conditions. (See chapter 5)

(6) Fall Protection. Harnesses and other personal fall protection equipment used in rope access must meet the ANSI Z359 requirements (see chapter 21).

(7) Work Seats. Whenever there is a need for personnel to remain suspended in one place for an extended period of time, a work seat may be used to provide additional support to that provided by the harness. The work seat must be fitted to the harness according to the manufacturer's instructions, and the climber's harness must remain the primary attachment point to the working line.

(8) Descender Devices. If descender devices are used, they must allow a controlled descent taking into consideration the weight of the worker, the length of the descent, considerations for safety, and the need for stopping along the working line for the purpose of hands-free work.

c. Safety, Secondary, Belay, or Back-up Line(s). Use safety, secondary, belay, back-up line(s), or other appropriate fall arrest devices in addition to the main line (working line) unless the employer can demonstrate that the second line or other fall arrest devices would create a greater hazard or otherwise would not be feasible. (23-8.c)

(1) Where a safety line is used in conjunction with the working line, each line must have its own separate anchor and must be separately fixed to the worker's harness. This does not preclude both lines being attached to a single harness attachment point.

(2) Connect the safety line of rope access systems to the sternal D-ring of the full body harness.

(3) When using a safety line, the maximum free-fall distance must not exceed six feet or the maximum distance specified by the manufacturer, whichever is less, and the maximum arrest force must not exceed 1,800 pounds (8 kN).

d. Rescue. The Rope Access Supervisor/QP for Rope Access must make provision for prompt rescue or self-rescue and arrange for emergency services. These provisions must be included in the Rope Access Plan according to paragraph 23-7. (23-8.d)

e. Tools Used During Rope Access. (23-8.e)

(1) Tools used by rope access workers must be compatible with the rope access system.

(2) Tools and work equipment attached to the Rope Access Technician or rope access systems must not impair the function of the main or back-up systems.

(3) Sheath all sharp tools when not in use.

(4) Take measures to prevent tools and work equipment from being dropped or from falling. Tether tools whenever possible or independently suspend them.

23-9. Figures and Tables.

Not Applicable.

23-10. Checklists and Forms.

Not Applicable.

Chapter 24 Safe Access

24-1. References.

a. ANSI/ASSP A10.4, Safety Requirements for Personnel Hoists and Employee Elevators on Construction and Demolition Sites (<https://webstore.ansi.org>) (24-1.a)

b. ANSI A10.22, Safety Requirements for Rope-Guided and Non-Guided Hoists (<https://webstore.ansi.org>) (24-1.b)

c. ANSI/ALI A14 Series (<https://webstore.ansi.org>) (24-1.c)

d. ASME A17, Safety Code for Elevators and Escalators (<https://webstore.ansi.org>) (24-1.d)

e. 29 CFR 1910 Subpart D, Walking-Working Surfaces (<https://www.govinfo.gov/content/pkg/CFR-2020-title29-vol5/pdf/CFR-2020-title29-vol5-part1910-subpartD.pdf>) (24-1.e)

f. 29 CFR 1926.552, Material Hoists, Personnel Hoists, and Elevators (<https://www.govinfo.gov/content/pkg/CFR-2020-title29-vol8/pdf/CFR-2020-title29-vol8-sec1926-552.pdf>) (24-1.f)

g. 29 CFR 1926 Subpart X, Stairways and Ladders (<https://www.govinfo.gov/content/pkg/CFR-2020-title29-vol8/pdf/CFR-2020-title29-vol8-part1926-subpartX.pdf>) (24-1.g)

24-2. Definitions.

a. Competent Person (CP). See paragraphs 1-2 or 2-2, as applicable. (24-2.a)

- b. Guardrail System. A rail system erected along unprotected or exposed sides, edges, or other areas of a walking-working surface to prevent persons from falling to a lower level. The system consists of a toprail, midrail, and their supports. (24-2.b)
- c. Handrail. A rail used to provide persons with a handhold for support. (24-2.c)
- d. Hole. Any gap or open space in a floor, roof, horizontal walking-working surface, or similar surface that measures at least 2 inches (5.1 cm) in its least dimension. (24-2.d)
- e. Ladder. A device incorporating or employing steps, rungs, or cleats on which a person may step or ascend or descend. (24-2.e)
- f. Ladder, Articulated. A portable ladder with one or more pairs of locking hinges which allows the ladder to be set up in several configurations (for example, single or extension ladder, with or without a stand-off, stepladder, trestle ladder, scaffold, worktable). (24-2.f)
- g. Ladder, Double-Cleated. A ladder, similar to a single cleat ladder, but with a center rail, which allows simultaneous two-way traffic for employees ascending or descending. (24-2.g)
- h. Ladder, Extension. A non-self-supporting portable ladder that consists of two or more sections, traveling guides or brackets, or the equivalent, and is adjustable in length. (24-2.h)
- i. Ladder, Fixed. A ladder that cannot be readily moved or carried because it is an integral part of a building or structure. (24-2.i)
- j. Ladder, Job-Made. A ladder fabricated by employees, typically at the construction site, and is not commercially manufactured. (24-2.j)
- k. Ladder, Platform. A self-supporting portable ladder of fixed size with a platform provided at the intended highest standing point. (24-2.k)
- l. Ladder, Portable. A ladder that can readily be moved or carried. It usually consists of side rails joined at intervals by steps, rungs, cleats, or rear braces. (24-2.l)
- m. Ladder, Single Cleat. A ladder consisting of a pair of side rails connected together by cleats, rungs, or steps. (24-2.m)
- n. Ladder, Single Rail. A portable ladder with rungs, cleats, or steps mounted on a single rail instead of the typical two rails. (24-2.n)

o. Ladder, Step Stool. A self-supporting, foldable, portable ladder, non-adjustable in length, 32 inches (81.3 cm) or less in height, with flat steps and without a pail shelf. It is designed to be climbed on the ladder top cap as well as all steps. (24-2.o)

p. Opening. Any gap or open space in a wall, partition, vertical walking-working surface, or similar surface that is at least 30 inches (76.2 cm) high and at least 18 inches (45.7 cm) wide, through which an employee can fall to a lower level. (24-2.p)

q. Qualified Person (QP). See paragraphs 1-2 or 2-2, as applicable. (24-2.q)

r. Ramp. Any inclined walking-working surface used to access another level. (24-2.r)

s. Registered Professional Engineer (RPE). See paragraphs 1-2 or 2-2, as applicable. (24-2.s)

t. Runway. A personnel passageway elevated above the surrounding floor or ground level, such as a foot walk along shafting or a walkway between scaffolds. (24-2.t)

u. Three Points of Contact. When either both hands and one foot, or both feet and one hand are always in contact with the climbing device. Required when ascending or descending ladders. (24-2.u)

v. Toe-board. A vertical barrier at floor level erected along exposed edges of a floor opening, wall opening, platform, runway, or ramp to prevent materials from falling. (24-2.v)

w. Trestle. A braced framework of timbers, piles, or steel work for carrying a walkway, road, or railroad over a depression. (24-2.w)

x. Unprotected Sides and Edges. Any side or edge, except at entrances to points of access, of a walking-working surface (for example, floor, roof, ramp, runway) where there is no wall, guardrail system, or stair rail system to protect persons from falling to a lower level. (24-2.x)

24-3. Personnel Required Qualification/Training.

Not Applicable.

24-4. Roles and Responsibilities.

If correction or repair to a means of access involved the structural integrity, a QP or CP must perform or supervise the correction or repair.

24-5. Inspection Requirements.

a. Accessways. Inspect means of access daily to ensure they provide safe access and are free of hazards, obstructions, and do not impede or restrict travel of personnel. (24-5.a)

b. Ladders. Inspect ladders according to the manufacturer's instructions. Inspect for visible defects prior to placing into service, before each use, and after any occurrence that could affect their safe use. Immediately tag broken or damaged ladders with "DO NOT USE", or with similar wording, and withdraw them from service until restored to a condition meeting their original design. (24-5.b)

c. Personnel Hoists and Elevators. Inspect personnel hoists and elevators according to the manufacturer's instructions and the applicable ANSI, ASME, and OSHA Standards (that is, ASME A17, ANSI A10.4, 29 CFR 1926.552, ANSI A10.22). (24-5.c)

24-6. Activity Hazard Analysis (AHA) Requirements.

Develop AHAs according to paragraphs 1-6 or 2-6, as applicable. During construction activities 20 feet (6.1 m) or more in height, address alternatives to the use of stairways in an AHA and submit them to the USACE supervisor for approval or KO or COR for acceptance.

24-7. Minimum Plan Requirements.

Not Applicable.

24-8. General Requirements.

a. General Accessway Requirements. (24-8.a)

(1) Provide a safe means of access to all work areas. Where danger exists of persons falling through floor, roof, wall openings, or holes, or from means of access (for example, platforms, runways, ramps, stairs, ladders) protect persons as detailed in this chapter or through use of fall protection. (See chapter 21)

(2) Where there is a break of 19 inches (48.3 cm) or more in a means of access, provide a stairway, ladder, ramp, runway, or personnel hoist.

(3) At entrance points to a means of access, use a self-closing gate or offset to prevent persons from walking directly into the opening.

(4) For additional means of access requirements, refer to chapter 19 for access on vessels and chapter 22 for access on work platforms and scaffolding.

(5) Do not use means of access constructed of metal for electrical work or where the potential exists to contact electrical conductors. Do not use portable or conductive ladders near energized lines or equipment.

(6) Inspect means of access daily.

(a) Keep means of access clean, clear, and free from hazards (for example, sharp or protruding objects, spills, ice) to allow free passage of workers.

(b) If work is performed in an area that free passage is restricted, provide another means of access (see para 24-5.a).

(c) Remove or conspicuously mark all obstructions or projections into a means of access. Cover obstructions or projections that are sharp, pointed, or that may cause lacerations, contusions, or abrasions with protective material.

(d) Where means of access are slippery, apply abrasive material to assure safe footing.

(e) Correct or repair hazardous conditions on means of access, to include physical hazards or damaged or weakened components before persons use the means of access. If the hazard cannot be eliminated or repair cannot be made immediately, guard the hazard to prevent persons from using the means of access until correction or repair is made. If correction or repair involves the structural integrity of the means of access, a QP or CP must perform or supervise the correction or repair.

(7) Design means of access to support the maximum intended load. Do not load above the design load or beyond the manufacturer's rated capacity.

(8) Determine the width of means of access by the purpose for which they are built and make them wide enough to provide safe passage for materials and movement of personnel. The width, except for ladders, must not be less than 18 inches (45.7 cm).

(9) Means of access must have overhead protection equal to 2 inches (5.1 cm) solid planking whenever work is performed over them, or if personnel are exposed to hazards from falling objects.

b. Safe Roof Access. (24-8.b)

(1) Provide level and guarded platforms at all roof landing areas.

(2) Crawling Boards.

(a) Crawling boards must at least 10 inches (25.4 cm) wide and 1 inch (2.5 cm) thick and have cleats 1 inch x 1.5 inches (2.5 cm x 3.8 cm).

(b) Cleats must be equal in length to the width of the board and spaced at equal intervals not to exceed 24 inches (61 cm).

(c) Drive nails through the boards and clinch them on the underside. Screws may be used in lieu of nails.

(d) When used with roof construction repairs, or maintenance, secure crawling boards and extend them from the ridge pole to the eaves.

(e) String a firmly fasted lifeline of at least three-quarter ($\frac{3}{4}$) inch (2 cm) diameter rope, or equivalent, beside each crawling board for use as a handhold.

(3) Access Paths. Erect access paths as follows:

(a) Connect points of access, material handling areas, and storage areas to the work area by a clear access path formed by two warning lines according to chapter 21.

(b) When the path to a point of access is not being used, do one of the following:

(b-1) Place a rope, wire, or chain, equal in strength and height to the warning line across the path at the point where the path intersects the warning line erected around the work area.

(b-2) Offset the path so that a person cannot walk directly into the work area.

c. General Ladder Requirements. See also chapter 22. This paragraph does not apply to ladders used in emergency operations (that is, firefighting, rescue, tactical law enforcement) or those designed into or as an integral part of machines or equipment. (24-8.c)

(1) Construct, install, use, maintain, and store ladders according to the manufacturer's instructions and ANSI/ASC A14 series standards, as applicable.

(a) Label ladders according to the applicable ANSI/ASC A14 series standards. The load ratings must be clearly and legibly marked on all ladders.

(b) Ladders should be safely secured when not in use.

(2) Inspect ladders according to paragraph 24-5.b. Ensure ladders are smooth surfaced to prevent injury to a worker from punctures or lacerations and to prevent snagging of clothing.

(3) Do not coat ladders with any opaque covering, except those applied by the manufacturer and for identification or warning labels according to the applicable ANSI/ASC A14 series standard.

(4) Do not use single-rail ladders.

(5) Three-legged ladders may be used for specific tasks, if approved by the USACE supervisor or accepted by the KO or COR.

(6) Install and use all ladder accessories according to the manufacturer's instructions. Accessories include, but are not limited to, ladder levelers, ladder stabilizers or stand-off devices, and ladder straps or hooks.

(7) Construct job-made wooden ladders according to ANSI/ASC A14.4.

(8) Provide fixed ladders with fall protection according to chapter 21.

(9) Articulated ladders are allowed if they meet ANSI/ASC A14.2.

d. Portable Ladders. In addition to the requirements of paragraph 24-8.c, portable ladders must also meet the following: (24-8.d)

(1) All portable ladders must be long enough and placed so that workers will not have to lean out beyond the ladder's side rails and assume a hazardous position.

(2) When portable ladders are used as a means of access, they must extend at least 3 feet (0.9 m) above the upper landing surface.

(a) When a 3 feet (0.9 m) extension above the upper landing surface is not possible, provide a grasping device (for example, grab rail) to assist workers in mounting and dismounting the ladder.

(b) In no case may the length of the ladder be such that ladder deflection under a load would, by itself, cause the ladder to slip from its support.

(3) The length of single ladders or individual sections of ladders must not exceed 30 feet (9.1 m).

(4) Two-section extension ladders must not exceed 48 feet (14.6 m) in length.

(5) Multi-section extension ladders (that is, over two-sections) must not exceed 60 feet (18.3 m) in length.

(6) The length of stepladders must not exceed 20 feet (6.1 m) in length.

(7) When splicing of side rails is required to obtain the required length, the resulting side rail must be at least equal in strength to a one-piece side rail made of the same material.

(8) Portable ladders must have slip-resistant feet.

(9) The rungs and steps of portable metal ladders must be corrugated, knurled, dimpled, coated with skid-resistant materials, or otherwise treated to minimize slipping.

(10) On each stepladder, ensure a metal spreader bar or locking device is provided to hold the front and back sections in an open position.

e. Set-up of Ladders. (24-8.e)

(1) Do not place ladders in passageways, doorways, drives, or any locations where they may be displaced by any other work, unless they are protected by barriers or guards or are secured to prevent accidental displacement.

(2) Portable ladders must be used at such a pitch that the horizontal distance from the working length (that is, top support to the foot of the ladder) will not be greater than $\frac{1}{4}$ of the vertical distance between these points.

(3) Wooden job-made ladders with spliced rail, must be used at an angle such that the horizontal distance is $\frac{1}{8}$ of the working length (that is, top support to the foot of the ladder) of the ladder.

(4) Ladders must be secured by top, bottom, and intermediate fastenings, as necessary, to hold them rigidly in place and to support the loads that will be imposed upon them. Examples where securing may be required include, but are not limited to, use on slippery or unstable surfaces or in areas where they may be displaced by other activities or traffic.

(5) Set the steps or rungs of all ladders to provide at least 7 inches (17.8 cm) toe space from the inside edge of the rungs to the nearest interference.

(6) The top of a non-self-supporting ladder must be placed with the two rails supported equally unless the ladder is equipped with a single support attachment.

(7) Step-across distance. The step-across distance from the nearest edge of the ladder to the nearest edge of equipment or structure must not be more than 12 inches (30.5 cm) or less than 2.5 inches (6.4 cm).

(8) Do not place ladders on boxes, barrels, or other unstable bases to obtain additional height.

f. Use of ladders. (24-8.f)

(1) Restrict ladder use to the purpose for which the ladder was designed.

(2) Keep three points of contact at all times when ascending or descending ladders.

(3) Do not move, shift, or extend a ladder while occupied.

(4) Do not load ladders beyond the maximum intended load for which they were designed and tested, or beyond the manufacturer's rated capacity (includes the worker and all the tools and supplies carried).

(5) No more than one person at a time may climb a ladder between the same set of rails unless designed to support more than one person.

(6) Portable ladders do not require fall protection when used as a means of access. However, only light work for short period of time may be performed on portable ladders, and only as approved by the USACE supervisor or accepted by the KO or COR. No work requiring lifting of heavy materials or substantial exertion may be done from ladders.

(7) When ladders are the only means of access to or from a working area for 25 or more workers, or when a ladder is to serve simultaneous two-way traffic, use double-cleated ladders or two or more separate ladders.

(8) Do not use the top cap or top step of a ladder as a step or seat unless it has been designed to be used as such by the manufacturer (for example, platform ladders).

(9) Ensure latches are in place before climbing an extension ladder.

(10) Keep loose tools off the steps and top platform.

(11) Do not make modifications to manufactured ladders to adapt the ladder to specific or special use, unless the alteration is approved by an RPE. Modified ladders must meet the applicable ANSI/ASC A14 series standard.

g. Floor, Wall, and Roof Holes and Openings. (24-8.g)

(1) Guard all floor, roof openings, or holes into which a person can accidentally walk or fall through either by a guardrail system with toe-boards along all exposed sides or by a load-bearing cover. When the cover is not in place, protect the opening or hole by a removable guardrail system or other fall protection system, or provide an attendant when the guarding system has been removed. (See chapter 21)

(2) Cover all floor and roof holes through which equipment, materials, or debris can fall.

(3) When exposed to vehicles or equipment, design conduits, trenches, and manhole covers and their supports to carry a truck rear axle load of two times the maximum anticipated load.

(4) Guard every hatchway and chute floor opening with a hinged floor opening cover. Barricade the opening with railings so there is only one exposed side. Provide the exposed side with either a swinging gate or an offset so that no one is able to walk into the opening. When operating conditions require the feeding of material into a hatchway or chute opening, provide protection to prevent a person from falling through the opening.

(5) Protect wall openings 30 inches (76.2 cm) or more in height and 18 inches (45.7 cm) or more in width from which a fall could occur with a standard guardrail or equivalent. Provide a toe-board where the bottom of the wall opening, regardless of width, is less than 4 inches (10.2 cm) above the working surface. (See chapter 21)

(6) An extension platform outside a wall opening onto which materials can be hoisted for handling must have a standard guardrail according to chapter 21. However, one side of the extension platform may have removable railings to facilitate handling materials if appropriate fall protection is used. (See chapter 21)

(7) Provide roof openings and holes with covers, guardrail systems, or warning line systems on all exposed sides.

Note. Skylights located in floors or roofs are considered floor or roof holes or openings.

(a) Immediately cut out roofing material (for example, roofing membrane, insulation, felts), that cover or partly cover openings or holes. Do not leave a hole or opening unattended unless covered according to chapter 21.

(b) Do not stand or walk on skylights.

(c) Guard non-load bearing skylights with a load-bearing skylight screen, cover, or raining system along all exposed sides.

h. Stairways. (24-8.h)

(1) On all structures 20 feet (6.1 m) or more in height, provide stairways during construction. Address alternatives to the use of stairways in an AHA according to paragraph 24-6.

(2) Use temporary stairways to provide access to the work level when permanent stairways are not installed concurrently with the construction of each floor. Temporary stairways must have landings not less than 30 inches (76.2 cm) in the direction of travel and extend at least 22 inches (55.8 cm) in width at every 12 feet (3.7 m) or less of vertical rise.

(3) Install stairs between 30° and 50° from horizontal.

(4) Risers must be of uniform height and treads of uniform depth within each flight of stairs. Stairway systems must not have any variations of more than one-quarter (¼) inch (0.6 cm) in any riser height or tread depth.

(5) When metal pan landings or metal pan treads are used, secure them in place and fill them with concrete, wood, or other material to at least the top of each pan.

(6) Nail wooden treads in place.

(7) Handrails.

(a) Handrails must provide adequately shaped and dimensioned handhold that allows for anyone grasping it to avoid falling.

(b) The height of handrails may not be more than 38 inches (96.5 cm) nor less than 30 inches (76.2 cm) from the upper surface of the handrail to surface of tread, in line with face of riser or to surface of the ramp. Existing installations do not need to be modified if they met the building code that was in effect at the time the facility was built.

(c) Provide all handrails and railings with a minimum clearance of 2¼ inches (5.7 cm) between the handrail or railing and any other object.

(8) Standard Stair Railings. Install standard stair railings around all stair wells.

(a) The height of stair rails must be 42 inches +/- 3 inches (106.7 cm +/- 7.6 cm) from the upper surface of the top rail to surface of the tread in line with face of the riser at forward edge of tread. Existing installations need not be modified.

(b) Provide midrails, screens, mesh, intermediate vertical members, or equivalent intermediate structural members between the top rail and the stairway steps.

(c) Locate midrails at a height midway between the top edge of the stairway system and the stairway steps.

(d) Screens or mesh, when used, must extend from the top rail to the stairway steps and along the entire opening between rail supports.

(e) Intermediate vertical members in between posts (for example, balusters), when used, may not be more than 19 inches (48.3 cm) apart.

(f) Install other structural members, when used, in such a manner so that there are no openings in the stair rail system that are more than 19 inches (48.3 cm).

(g) The top rails of stair rail systems must be capable of withstanding, without failure, a force of at least 200 pounds (0.9 kN) applied in any downward or outward direction within 2 inches (5.1 cm) of any point along the top edge of the rail.

(9) Every flight of stairs with four or more risers or rising more than 30 inches (76.2 cm) must have standard stair railings or standard handrails.

(a) On stairways less than 44 inches (111.8 cm) wide with both sides enclosed, install at least one standard handrail, preferably on the right descending side.

(b) On stairways less than 44 inches (111.8 cm) wide with one side open, install at least one standard stair railing on the open side.

(c) On stairways less than 44 inches (111.8 cm) wide with both sides open, install one standard stair railing on each side.

(d) On stairways more than 44 inches (111.8 cm) wide, but less than 88 inches (223.5 cm) wide, install one standard handrail on each enclosed side and one standard stair railing installed on each open side.

(e) On stairways more than 88 inches (223.5 cm) wide, install one standard handrail on each enclosed side, one standard stair railing on each exposed side, and a standard handrail in the middle of the stairway.

(10) Turn the ends of handrails and stair rails into the supporting wall or partition or otherwise arrange them so they do not constitute a projection hazard.

(11) Stair rail systems and handrails must be smooth surfaced to prevent injury, such as punctures and lacerations, and to prevent snagging of clothing and equipment.

(12) Doors or gates opening onto a stairway must have a platform and the swinging of the door may not reduce the width of the platform to less than 22 inches (55.9 cm) if installed after January 17, 2017, or 20 inches (50.8 cm) if installed prior.

(13) Do not install spiral stairways, except for special limited usage and secondary access where it is not practical to provide a conventional stairway. Provide, use, and maintain spiral stairways according to the manufacturer's instructions.

(14) Maintain three points of contact at all times when ascending or descending spiral stairs, ship stairs, or alternating tread stairs.

i. Ramps, Runways, and Trestles. (24-8.i)

(1) Ramps, runways, and platforms must be as flat as conditions will permit. Apply traverse cleats to the working surface where the slope exceeds 1 foot:5 feet (0.3 m:1.5 m).

(2) Provide vehicle ramps, trestles, and bridges on which foot traffic is permitted with a walkway and guardrail located outside the roadway. Provide the roadway

structures with wheel guards, fender logs, or curbs not less than 8 inches (20.3 cm) high and place them parallel with and secured to the sides of the runway.

(3) When used in lieu of steps, provide ramps with cleats to ensure safe access.

j. Personnel Hoists and Elevators. (24-8.j)

(1) Design, construction, installation or erection, operation, inspection, testing, and maintenance of personnel hoists and elevators must be according to the manufacturer's instructions, ANSI/ASSP A10.4, ANSI A10.22, ASME A17 and the applicable OSHA standards (for example, 29 CFR 1926.552).

(2) Keep a copy of the manufacturer's manual covering construction, installation or erection, operation, inspection, testing, and maintenance, and a copy of the applicable ANSI and/or ASME standards available onsite.

24-9. Figures and Tables.

Not Applicable.

24-10. Checklists and Forms.

Not Applicable.

Chapter 25

Excavation and Trenching

25-1. References.

a. ER 385-1-95, Safety and Health Requirements for Operations and Activities Involving Munitions and Explosives of Concern (MEC)
(<https://www.publications.usace.army.mil/USACE-Publications/Engineer-Regulations/>)
(25-1.a)

b. 29 CFR 1926 Subpart P, Excavations
(<https://www.govinfo.gov/content/pkg/CFR-2020-title29-vol8/pdf/CFR-2020-title29-vol8-part1926-subpartP.pdf>) (25-1.b)

25-2. Definitions.

a. Barricade. A physical obstruction (for example, tape, screens, cones) intended to warn of and limit access to a hazardous area. (25-2.a)

b. Benching. A method of protecting employees from cave-ins by cutting the sides of the excavation in the arrangement of one or more horizontal levels, usually with vertical or near-vertical walls between steps. (25-2.b)

c. Cofferdam. A temporary structure used to keep water (and earth) out of an excavation during construction of the permanent structure. (25-2.c)

d. Competent Person (CP), Excavations. A person designated in writing by the employer to be responsible for the immediate supervision, implementation, and monitoring of the Excavation and Trenching Plan. Must have training, knowledge, and experience in excavation and trenching to be capable of identifying, evaluating, and addressing existing and potential hazards. This individual must have the authority to take prompt corrective measures with regard to such hazards. The term “Competent Person (CP)” as used in this chapter, refers to “Competent Person, Excavations.” (25-2.d)

e. Perimeter Protection. Measures taken to prevent personnel, vehicles, and materials from falling into an excavation. (25-2.e)

f. Protective System. Methods used to protect employees from cave-ins, from material falling into an excavation, or from the collapse of adjacent structures. Systems include benching, sloping, shoring, trench shields, underpinning, rock bolting, and similar. (25-2.f)

g. Scaling. The removal of loose, overhanging, protruding, or otherwise precariously positioned material from above or along the sides of an excavation. (25-2.g)

h. Sloping. A method of protecting employees from cave-ins by cutting the sides of the excavation in the arrangement of slopes. The angle of the slope needed to prevent cave-in is a function of the soil type, environmental factors such as moisture and freezing weather, and the magnitude and location of any loads and vibration surcharged upon the slopes. (25-2.h)

i. Stable Rock. Natural, solid, mineral material that can be excavated with vertical sides and remain intact while exposed. (25-2.i)

j. Support System. A structural means of supporting the walls of an excavation to prevent cave-ins. Systems include shields, shoring, underpinning, rock bolts, and similar. (25-2.j)

25-3. Personnel Required Qualification/Training.

a. Competent Person (CP). (25-3.a)

(1) CPs must have training, knowledge, and experience in soil analysis, use of protective systems, and the requirements of this chapter and 29 CFR 1926 Subpart P.

(2) CPs must be able to demonstrate the ability to detect conditions that could result in cave-ins, failures in protective systems, hazardous atmospheres, and other hazards including those associated with confined spaces.

(3) CPs must have the authority to stop work and take prompt corrective measures to eliminate existing and predictable hazards if it is determined to be unsafe.

b. Rescue Personnel. Personnel conducting rescue operations must be trained on rescue procedures identified in the Excavation and Trenching Plan (see para 25-7.i). (25-3.b)

25-4. Roles and Responsibilities.

a. Competent Person (CP). The CP is responsible for: (25-4.a)

(1) Developing the Excavation and Trenching Plan (see para 25-7) and AHA (see para 25-6).

(2) Conducting documented inspections of excavations to identify and control for any existing or potential hazards (see para 25-5.a).

(3) Immediately stopping the work if it is determined to be unsafe and take prompt corrective measures to mitigate the hazards.

(4) Performing soil classification testing (see paras 25-5.b and 25-8.i).

(5) Examining material or equipment used for protective systems when they are damaged to evaluate its suitability for continued use (see para 25-8.j).

(6) Determining exemptions for the use of fall protection for inspectors and supervisor (see para 25-8.h).

(7) Evaluating the need for air monitoring (see para 25-5.c).

(8) Monitoring water control equipment and operations to ensure proper operation (see para 25-8.c).

(9) The CP for excavations and trenching must always be onsite when such work is being performed.

b. Qualified Person (QP). The QP is responsible for: (25-4.b)

(1) Designing Class 1 perimeter protection to guard against vehicles or equipment from falling into an excavation (see para 25-8.h).

(2) Designing ramps used for equipment access into excavations (see para 25-8.h).

c. Registered Professional Engineer (RPE). The RPE is responsible for: (25-4.c)

(1) Evaluating and determining that adjacent structures are sufficiently removed from the excavation or supported prior to excavating below a footing (see para 25-8.b).

(2) Planning and directing any freezing, pumping, drainage, or similar control measures (see para 25-8.c).

(3) Designing tabulated data for use with support system (see para 25-8.i).

(4) Designing sloping or benching for excavation over 20 feet (6 m) in depth (see para 25-8.i).

d. Rescue Personnel. Rescue personnel must conduct rescue operations according to the written rescue procedures (see para 25-7.i). (25-4.d)

25-5. Inspection Requirements.

a. Excavations. When workers will be in or around an excavation, a CP must conduct documented inspections of each excavation, the adjacent areas, and protective systems at the following frequencies: (25-5.a)

(1) Before each work shift and throughout the work shift as dictated by the work being done.

(2) After every rainstorm or event that could increase hazards (for example, snowstorm, thunderstorm, thaw, earthquake).

(3) When fissures, tension cracks, sloughing, undercutting, water seepage, bulging at the bottom, or similar conditions occur.

(4) When there is a change in size, a change in location, or creation of a spoil pile.

(5) Where there is any indication of change in adjacent structures.

b. Soil Conditions/Classification. The CP must inspect and test the soil conditions, at minimum, prior to the start of each work shift and as conditions warrant to determine the soil classification. Document and maintain the results for the life of the project (for example, in QC Daily Reports, excavation inspection logs). (See para 25-8.i) (25-5.b)

c. In excavations 4 feet (1.2 m) or greater in depth where oxygen deficiency or gaseous conditions are known or suspected, test the air prior to the start of each shift or more often if directed by the CP. Maintain a log of all test results at the work site. (25-5.c)

25-6. Activity Hazard Analysis (AHA) Requirements.

Develop AHAs according to paragraphs 1-6 or 2-6, as applicable. An AHA is required to be developed by a CP for all work in excavations and trenches. The AHA must include the following:

- a. For all piping activities, include workers' increased exposure during connection activities (for example, bent over, kneeling). (25-6.a)
- b. Methods and locations for egress. (25-6.b)
- c. Identification and credentials of the CP, Excavation. (25-6.c)
- d. Documentation that examination of the ground by the CP results in no indication of a potential cave-in. (25-6.d)

25-7. Minimum Plan Requirements.

Excavation and Trenching Plan. An Excavation and Trenching Plan is required when excavations or trenches are 5 feet (1.5 m) or more in depth. The plan must be developed by a CP, submitted, and approved by the USACE supervisor or accepted by the KO or COR prior to beginning work. The plan must include the following:

Note. For excavations or trenches less than 5 feet (1.5 m) in depth, or made entirely in stable rock, an Excavation and Trenching Plan is optional.

- a. Activity Hazard Analysis (AHA) (see para 25-6). (25-7.a)
- b. Detailed description of activity being performed to include a diagram or sketch of the work area with adjacent and nearby structures shown and locations of utility shut offs, if required. (25-7.b)
- c. Description of the anticipated hazards or concerns and control measures that will be implemented to control to an acceptable level, to include: (25-7.c)
 - (1) Projected soil types and methods of testing to determine soil type (see table 25-2).
 - (2) Projected maximum depth of the excavation and planned method of shoring, sloping, or benching. Shoring, sloping, or benching for excavations over 20 feet (6.1 m) in depth must be designed by an RPE. (See para 25-4.c.)

(3) Plan for management of excavated materials (for example, soil, asphalt, concrete, stone).

(4) Methods to provide safe access (see para 25-8.h).

(5) Proposed methods for preventing damage to overhead utility lines, trees designated to remain, and other man-made facilities or natural features designated to remain within or adjacent to the limits of work.

(6) Plan for traffic control (see chapter 5).

(7) Atmospheric monitoring procedures and planned method for confined space entry as applicable (see chapter 34).

d. Assignment of personnel and their roles and responsibilities. Include necessary information/documentation to support qualification/training of such persons (see paras 18-3, 25-3, and 34-3). (25-7.d)

e. Inspection and oversight methods to ensure adherence to the plan. (25-7.e)

f. Process for obtaining dig permits (for example, excavation permits) according to paragraph 25-8.f. (25-7.f)

g. Certification of unexploded ordnance (UXO) disposal clearance as applicable (see para 25-8.g). (25-7.g)

h. For cofferdams. Prepare a Controlled Flooding Plan that includes fall protection, access and egress, and evacuation procedures (see para 25-8.k). (25-7.h)

i. Rescue Procedures. Employers must provide prompt rescue to all buried workers. (25-7.i)

(1) Site and task specific procedures for self-rescue and assisted rescue of any worker who is buried during a cave-in to include rescue equipment.

(2) Include any other planned methods of rescue (that is, by a jurisdictional, public or Government emergency rescue agencies) and include the point of contact information necessary to contact and summon the agency to the accident site.

(3) If using local emergency response services (for example, local fire/emergency medical services), include a Memorandum of Agreement or Memorandum of Understanding with local responders.

25-8. General Requirements.

The requirements of this chapter are applicable to all Government and contractor work forces when their employees are performing excavation or trenching activities.

a. Protective Systems. (25-8.a)

(1) Protective systems must have the capacity to resist without failure all loads that are intended or could reasonably be expected to be applied or transmitted to the system.

(2) Guard the sides of all excavations in which employees are exposed to danger from moving ground by a support system, sloping or benching of the ground, or other equivalent means.

(3) A protective system is not required for excavations less than 5 feet (1.5 m) in depth and which a CP examines, determines, and documents that there is no potential for cave-in. However, a fixed means of egress must be still provided.

(4) Slope and bench according to paragraph 25-8.i.

(5) Use and install support systems according to paragraph 25-8.j.

(6) Shore unstable soil or excavations deeper than 5 feet (1.5 m) unless benching, sloping, or another acceptable plan is implemented and approved by the USACE supervisor or accepted by the KO or COR.

(7) If evidence of a situation that could result in possible cave-ins, slides, failure of protective systems, hazardous atmospheres, or other hazardous condition is identified, remove exposed workers from the hazard and stop all work in the excavation until all necessary safety precautions have been implemented.

b. Stability of Adjacent Structures. (25-8.b)

(1) Except in stable rock, do not excavate below the level of the base of footing of any foundation or retaining wall unless one of the following is met:

(a) A support system, such as underpinning, is provided to ensure the stability of the structure and to protect employees involved in or adjacent to the excavation work.

(b) An RPE has determined that the structure is sufficiently removed from the excavation so that it is not affected by the excavation and the excavation will not pose a hazard to employees.

(2) If the stability of adjoining buildings or walls is endangered by excavations, then an RPE must design the shoring, bracing, or underpinning to ensure the stability of the structure and to protect employees.

(3) Do not undermine sidewalks, pavements, and related structures unless a support system is provided to protect employees and the sidewalk, pavement, or related structure.

(4) Where it is necessary to undercut the side of an excavation, safely support the overhanging material.

c. Protection from Water. (25-8.c)

(1) Use diversion ditches, dikes, or other means to prevent surface water entering an excavation and to provide good drainage of the area adjacent to the excavation.

(2) Do not work in excavations in which there is accumulated water or in which water is accumulating unless the water hazards posed by accumulation is controlled.

(a) An RPE must plan and direct freezing, pumping, drainage, and similar control measures. Address existing moisture balances in surrounding soils and the effects on foundations and structures if it is disturbed.

(b) When continuous operation of ground water control equipment is necessary, provide an emergency power source. The CP must monitor water control equipment and operations to ensure proper operation.

d. Protection from Falling Material. (25-8.d)

(1) Protect employees from loose rock or soil that could create a hazard by falling from the excavation wall by scaling, ice removal, benching, barricading, rock bolting, wire mesh, or other means. Give special attention to slopes that may be adversely affected by weather, moisture content, or vibration.

(2) Remove or make safe materials (for example, boulders, stumps) that may slide or roll into the excavation.

(3) Place excavated material at least 2 feet (0.6 m) from the edge of an excavation or retain it using devices that are sufficient to prevent the materials from falling into the excavation. In any case, place material at a distance to prevent excessive loading on the face of the excavation.

(4) Do not work on the faces of sloped or benched excavations at levels above other employees except when employees at lower levels are adequately protected from the hazard of falling material or equipment.

e. Mobile Equipment and Motor Vehicle Precautions. (25-8.e)

(1) When vehicles or mobile equipment are used or allowed adjacent to an excavation, install substantial stop logs or barricades. The use of a ground guide is recommended.

(2) Workers must stand away from vehicles being loaded or unloaded to avoid being struck by spillage or falling materials.

(3) Do not allow excavating or hoisting equipment to raise, lower, or swing loads over or adjacent to personnel in the excavation without substantial overhead protection. Personnel must maintain a safe distance from hoisting operations until the load has been placed.

Note. Any equipment used to hoist loads, with the use of rigging attached to the equipment (to include excavators, forklifts) must be considered “LHE” or “hoisting equipment” and as such, must follow the requirements in chapter 16.

(4) Employees exposed to equipment or vehicular traffic must wear high visibility apparel according to chapter 5.

f. Underground Utilities. Locate all underground utilities (for example, communication, water, fuel, electric lines) and protect them from damage or displacement. (25-8.f)

(1) Obtain a dig permit (for example, excavation permits) from the local public works organization or other AHJ prior to starting any excavation work. Process the permit requests through the USACE supervisor/KO or COR.

(2) Contact utility companies and other responsible authorities to locate and mark the underground utilities and, if they so desire, direct or assist with protecting them.

(3) If working within 3 feet (0.9 m) of underground utilities, physically verify utility location using non-destructive methods and neutralize the utility system.

(4) When operations approach the location of underground utilities, excavate with caution until the exact location of the utility is found.

(5) Protect workers from the utility and protect the utility from damage or displacement.

g. Hazardous Conditions. (25-8.g)

(1) Employees entering excavations classified as confined spaces, or that otherwise present the potential for emergency rescue (for example, bell-bottom pier

holes), must follow confined space entry procedures to include wearing rescue equipment and maintaining communication with the (confined space) Attendant (see chapter 34).

(2) Where excavations are to be performed in areas known or suspected to contain explosives, unexploded munitions, or military ordnance, ensure that surface and subsurface UXO is surveyed, cleared, and disposed of by an explosive UXO disposal personnel prior to excavation work (see ER 385-1-95).

h. Safe Access. (25-8.h)

(1) Provide perimeter protection to prevent personnel, vehicles, and equipment from falling into excavations according to the following hierarchy:

(a) Class I perimeter protection is required if the excavation is exposed to members of the public or vehicles or equipment.

(a-1) Class I perimeter protection must meet the requirements of a guardrail system according to chapter 21.

(a-2) Class I perimeter protection guarding against traffic (for example, vehicles, equipment) falling into an excavation must be designed, by a QP, to withstand the potential forces due to impact by traffic.

(b) Class II perimeter protection, at minimum, is required if the excavation does not meet the requirements for Class I perimeter protection but is: routinely exposed to employees and is deeper than 6 feet (1.8 m) or contains hazards (for example, impalement, hazardous substances).

(b-1) Class II perimeter protection consists of warning barricades or flagging placed not closer than 6 feet (1.8 m) from the edge of the excavation.

(b-2) Warning barricades or flagging do not have to meet the requirements for Class I perimeter protection but do need to display an adequate warning at an elevation of 3 feet (0.9 m) to 4 feet (1.2 m) above ground level (AGL).

(b-3) When workers are in the zone between the warning barricades or flagging and the excavation, provide them with appropriate fall protection according to chapter 21.

(c) Class III perimeter protection, at minimum, is required if the excavation does not meet the requirements for either Class I or Class II perimeter protection.

(c-1) Class III. Perimeter protection consists of warning barricades or flagging placed not closer than 6 inches (15.2 cm) nor more than 6 feet (1.8 m) from the edge of the excavation.

(c-2) Warning barricades or flagging do not have to meet the requirements for Class I perimeter protection but do need to display an adequate warning at an elevation of 3 feet (0.9 m) to 4 feet (1.2 m) AGL.

(c-3) When workers are in the zone between the warning barricades or flagging and the excavation, provide them with appropriate fall protection according to chapter 21.

(2) Barricade or cover all wells, calyx holes, pits, shafts, and similar.

(3) Backfill excavations as soon as possible. Upon completion of exploration and similar operations, backfill test pits, temporary wells, calyx holes, and similar immediately.

(4) Provide walkways or bridges with standard guardrails according to chapter 21 where people or equipment are required or permitted to cross over excavations.

(5) Where personnel are required to enter excavations or trenches over 4 feet (1.2 m) in depth, provide sufficient stairs, ramps, or ladders. Such means of egress must be provided at intervals so that no more than 25 feet (7.6 m) of lateral travel is required in order to access.

(a) Provide at least two means of exit for personnel working in excavations. Where the width of the excavation exceeds 100 feet (30.5 m), provide two or more means of exit on each side of the excavation.

(b) When access to excavations more than 20 feet (6.1 m) in depth is required, provide ramps, stairs, or mechanical personnel hoists.

(6) Ramps. Install ramps according to chapter 24.

(a) Ramps used solely for personnel access must be a minimum width of 4 feet (1.2 m) and provided with standard guardrails according to chapter 21.

(b) Ramps used for equipment access must be a minimum width of 12 feet (3.7 m). Provide curbs not less than 8 inches x 8 inches (20.3 cm x 20.3 cm), timbers, or equivalent protection. Equipment ramps must be designed by a QP qualified in structural design.

(7) Ladders used as access ways must extend from the bottom of the excavation to not less than 3 feet (0.9 m) above the surface.

(8) Provide fall protection for persons when inspecting or testing in or around an excavation that is between 6 feet (1.8 m) and 20 feet (6.1 m) deep, that has a vertical

face leading edge fall exposure (that is, sides have not been laid back), or that contains hazards (for example, impalement hazards, hazardous substances) (see chapter 21).

Note. Exception. The designated CP for Excavation may exempt the use of fall protection for inspectors or supervisors provided those individuals are not exposed to hazards within 24 inches (61 cm) of edges, the excavation contains no additional hazards and the individual(s) stay a minimum of 24 inches (61 cm) from the excavation's edge.

i. Sloping and Benching. Sloping or benching of the ground must follow one of the systems outlined below (see figures 25-1 and 25-2). (25-8.i)

(1) Allowable configurations and slopes. For excavations 20 feet (6.1 m) or less in depth, do not exceed an angle of 34° measured from the horizontal (that is, 1-1/2 horizontal to 1 vertical). Excavate these slopes to form configurations according to the slopes shown for Type C soil in figure 25-1.

(2) Determination of slopes and configurations using classification of soil and rock deposits. For excavations 20 feet (6.1 m) or less in depth, use classification of soil and rock deposits to determine slope configurations according to 29 CFR 1926, Subpart P, Appendices A and B. (See figure 25-1)

(a) Soil classification must be conducted by a CP and include at least one visual and one manual test (for example, pocket penetrometer, plasticity/wet thread test, shear vane test).

(b) Classify layered soils based on the soil classification of the weakest layer. Each layer may be classified individually if a more stable layer lies below a less stable layer (that is, Type C over Type B) (see table 25-1).

(3) Designs using other tabulated data. Select the design from and according to written tabulated data, such as charts and tables approved by an RPE. Maintain at least one copy of the tabulated data at the jobsite during excavation. The tabulated data must include the following:

(a) Identification of the parameters that affect the selection of a sloping or benching system drawn from the data.

(b) Identification of the limits of use of the data, to include the magnitude and configuration of slopes determined to be safe.

(c) Explanatory information as may be necessary to aid the user in correctly selecting a protective system from the data.

(d) The identity of the RPE who approved the data.

(4) Design by an RPE. Slope or bench according to designs prepared by an RPE. Maintain at least one copy of the design at the jobsite during excavation. Designs must be in writing and include the following:

(a) The magnitudes and configurations of the slopes that were determined to be safe for the excavation.

(b) The identity of the RPE who approved the design, including name and contact information.

j. Support Systems, Shoring, and Shielding. Support systems, including shield systems and other protective systems, must follow one of the following systems: (25-8.j)

(1) Designs using manufacturer's tabulated data. Implement designs based on manufacturer's tabulated data. Follow all specifications, limitations, and recommendations issued or made by the manufacturer.

(a) Deviation from the specifications, recommendations, and limitations are only allowed after the manufacturer issues specific written approval.

(b) Maintain a written copy of the manufacturer's specifications, recommendations, and limitations, and the manufacturer's approval to deviate from these, if required, at the jobsite during excavation.

(2) Designs using other tabulated data. Select the design from and according to written tabulated data, such as charts and tables approved by an RPE. Maintain at least one copy of the tabulated data at the jobsite during excavation. The tabulated data must include the following:

(a) Identification of the parameters that affect the selection of the protective system drawn from such data.

(b) Identification of the limits of use of the data.

(c) Explanatory information as may be necessary to aid the user in correctly selecting a protective system from the data.

(d) The identity of the RPE who approved the data to include name and contact information.

(3) Designed by an RPE. Implement support systems, shoring, or shielding based on designs prepared by an RPE. Maintain at least one copy of the designs at the jobsite during excavation. Designs must be in writing and include the following:

(a) A plan indicating the sizes, types, and configurations of the materials to be used in the protective system.

(b) The identity of the RPE who designed the support system to include name and contact information.

(4) Materials and Equipment Used for Support Systems.

(a) Materials and equipment must be free from damage or defects that might impair their proper function.

(b) Use and maintain manufactured materials and equipment in a manner consistent with the recommendations of the manufacturer and in a manner that will prevent employee exposure to hazards.

(c) When material or equipment is damaged, a CP must examine the material or equipment and evaluate its suitability for continued use.

(5) Installation and Removal of Support Systems.

(a) Support excavations less than 20 feet (6.1 m) in depth which have vertically lowered portions to a height at least 18 inches (45.7 cm) above the top of the vertical side (see figure 25-3).

(b) Do not excavate to a level more than 2 feet (0.6 m) below the bottom of the members of a support system. Excavation of material to a level of 2 feet (0.6 m) below the bottom of the members of a support system is only permitted if the system is designed to resist the forces calculated for the full depth of the trench, and there are no indications while the trench is open of a possible loss of soil from behind or below the bottom of the support system.

(c) Closely coordinate the installation of support systems with the excavation of the trenches.

(d) Install and remove support systems in manners that protect employees from cave-ins, structural collapses, or from being struck by members of the support system.

(e) Do not subject individual members of a support system to loads exceeding those for which they were designed to withstand.

(f) Securely connect the support system members to prevent sliding, falling, kickouts, or other predicable failure.

(g) Before temporary removal of individual members, take additional precautions to ensure the safety of employees (for example, installing other structural members to carry the loads imposed on the support system).

(h) Begin removal at, and progress from, the bottom of the excavation. Slowly release members to allow notice of any indication of possible failure of the remaining members or possible cave-in of the sides of the excavation. In unstable soil, use ropes to pull out the jacks or braces from above after personnel have cleared the trench.

(i) Backfilling must progress together with the removal of support systems from excavations.

(j) Shield Systems.

(j-1) Install shields in a manner to restrict lateral or other hazardous movement of the shield in the event of the application of sudden lateral loads.

(j-2) Protect employees from the hazard of cave-ins when entering or exiting the area protected by shields.

(j-3) Do not allow employees inside shields when shields are being installed, removed, or moved.

k. Cofferdams. (25-8.k)

(1) If overtopping of the cofferdams by high water is possible, design must include provisions for controlled flooding of the work area (see para 25-7.h).

(2) If personnel or equipment are required or permitted on cofferdams, provide standard guard railings, or equivalent protection according to chapter 21.

(3) Provide walkways, bridges, or ramps with at least two means of rapid exit for personnel and equipment working on cofferdams. Equip these means of egress with standard guardrails according to chapter 21.

(4) Develop evacuation procedures that includes warning signals for evacuation of personnel and equipment in case of emergency and for controlled flooding (see para 25-7.h). Post the procedures at the jobsite.

(5) Protect cofferdams located close to navigable shipping channels from vessels in transit.

25-9. Figures and Tables.

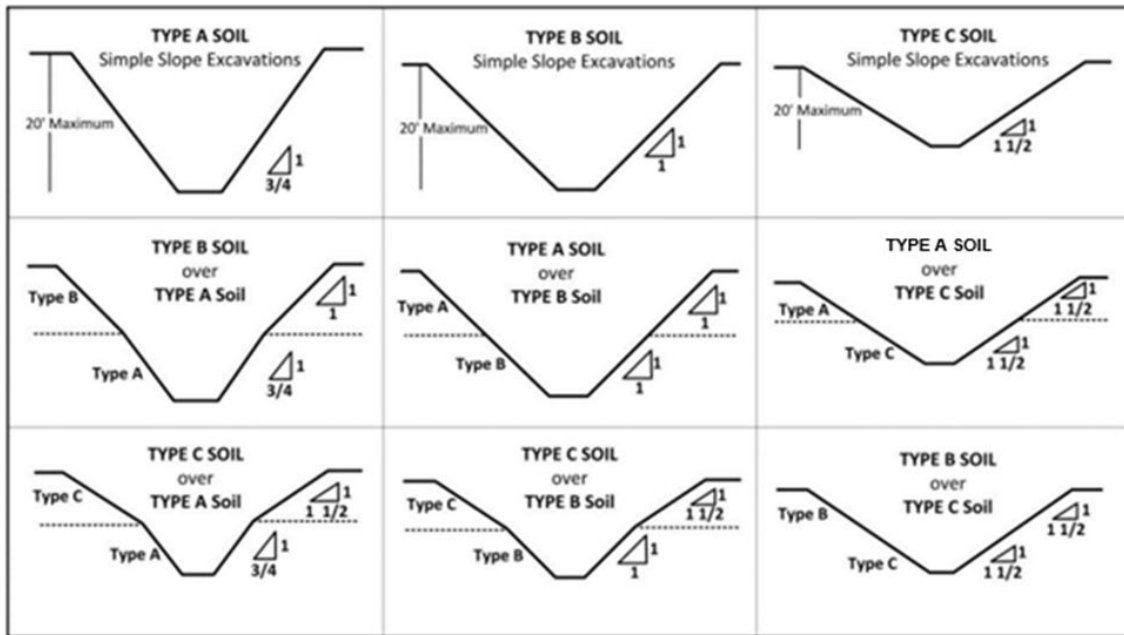

Figure 25-1. Allowable Sloping Configurations for Type A, Type B, and Type C Soils

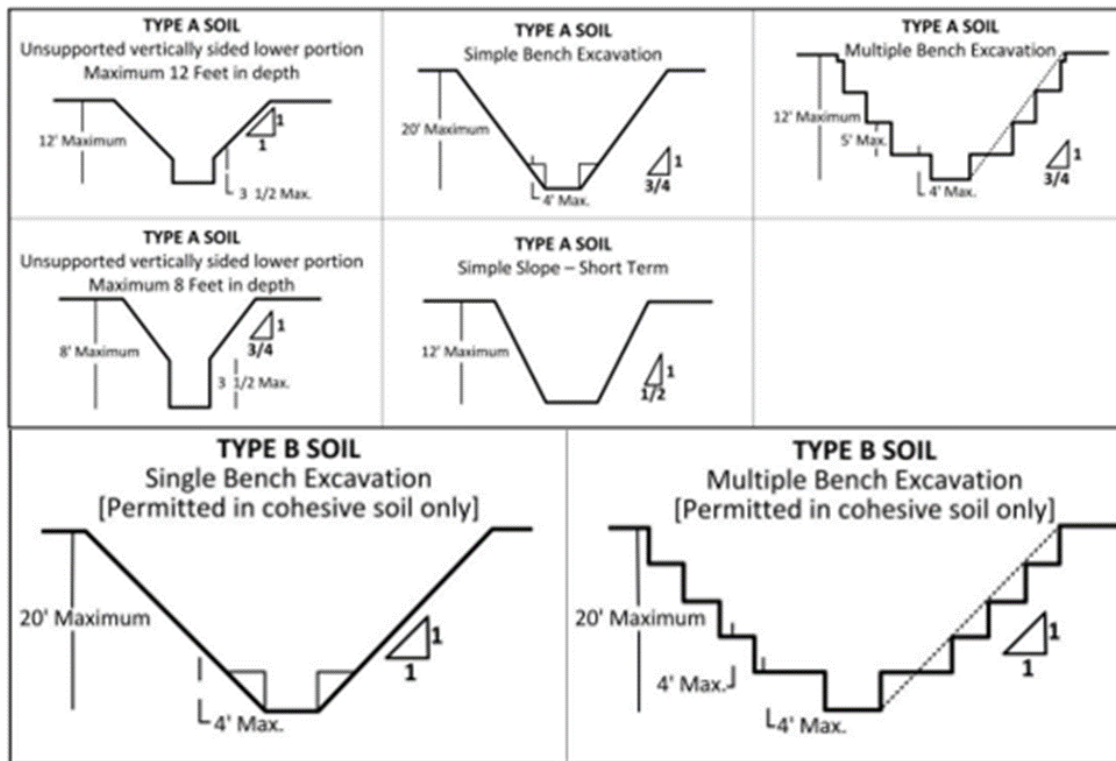
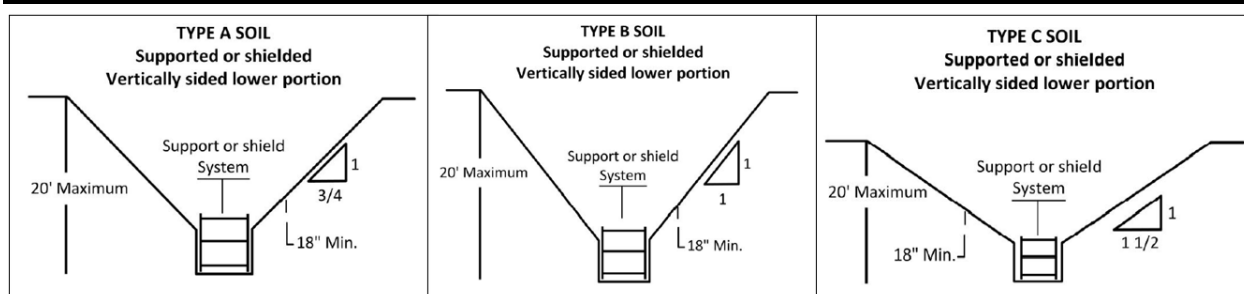

Figure 25-2. Allowable Benching and Sloping for Type A and Type B Soils



Note:

All excavations which have vertically sided lower portions must be shielded or supported to a height at least 18 inches (45.7 cm) above the top of the vertical side.

Figure 25-3. Excavations with Vertically Sided Lower Portions

Table 25-1

Soil classification

Soil Type	Criteria	Other Considerations
Stable Rock	Natural solid mineral that can be excavated with vertical sides and remain intact while exposed.	Not Applicable.
Type A	Cohesive soil with an unconfined compressive strength of 1.5 tons per square foot (tsf) (144 kPa) or greater.	Cannot be Type A if soil is: <ul style="list-style-type: none"> Fissured; Subject to vibration from heavy traffic, pile driving, etc.; Previously disturbed; Part of sloped, layered system where layers dip into excavation on a slope of 4H:1V or greater; or Subject to other factors requiring it to be classified as less stable material.
Type B	Cohesive soil with an unconfined compressive strength greater than 0.5 tsf (48 kPa) but less than 1.5 tsf (144 kPa)	Type B soil can also be: <ul style="list-style-type: none"> Granular cohesionless soils such as angular gravel, silt, silt loam, sandy loam, and in some cases, silty clay loam and sandy clay loam; Previously disturbed soils except those which would otherwise be classed as Type C soil; Soil that meets the requirements of Type A, but is fissured or subject to vibration; Dry rock that is not stable; or Part of sloped, layered system where layers dip into excavation on a slope of 4H:1V, but only if the soil would otherwise be classed as Type A.

Table 25-1**Soil classification— Continued**

Soil Type	Criteria	Other Considerations
Type C	Cohesive soil with an unconfined compressive strength of 0.5 tsf (48 kPa) or less.	Type C soil can also be: <ul style="list-style-type: none"> • Granular soils including gravel, sand, and loamy sand; • Submerged soil or soil from which water is freely seeping • Submerged rock that is not stable; or • Part of sloped, layered system where layers dip into excavation on a slope of 4H:1V or steeper. • Can NOT be benched!

Table 25-2**Maximum Allowable Slopes By Soil Type**

Soil Type	Maximum Allowable Slopes (H:V)
Stable Rock	Vertical (90°)
Type A Soil	¾:1 (53°) or ½:1 (63°) short term*
Type B Soil	1:1 (45°)
Type C Soil	1½: 1 (34°)

*A short term (<24 hours) maximum allowable slope of ½:1 (63°) is allowed in excavations in Type A soil that are 12 feet (3.7 m) or less in depth.

25-10. Checklists and Forms.

Not Applicable.

Chapter 26**Underground Construction, Shafts, and Caissons****26-1. References.**

- a. ASME B31, Code for Pressure Piping (<https://www.asme.org>) (26-1.a)
- b. EM 1110-1-2907, Rock Reinforcement
(<https://www.publications.usace.army.mil/USACE-Publications/Engineer-Manuals/>)
(26-1.b)
- c. EM 1110-1-2908 Rock Foundation
(<https://www.publications.usace.army.mil/USACE-Publications/Engineer-Manuals/>)
(26-1.c)

- d. EM 1110-2-2901, Tunnels and Shafts in Rocks
(<https://www.publications.usace.army.mil/USACE-Publications/Engineer-Manuals/>) (26-1.d)
- e. EPA National Pollutant Discharge Elimination System (NPDES)
(<https://www.epa.gov/npdes>) (26-1.e)
- f. NFPA 122, Standard for Fire Prevention and Control in Metal/Nonmetal Mining and Metal Mineral Processing Facilities
(<https://www.nfpa.org/Codes-and-Standards>) (26-1.f)
- g. NFPA 55, Compressed Gases and Cryogenic Fluids Code
(<https://www.nfpa.org/Codes-and-Standards>) (26-1.g)
- h. NFPA 70, National Electrical Code
(<https://www.nfpa.org/Codes-and-Standards>) (26-1.h)
- i. NFPA 1006 Standard for Technical Rescue Personnel Professional Qualifications (<https://www.nfpa.org/Codes-and-Standards>) (26-1.i)
- j. UFC 3-601-02, Fire Protection Systems Inspection, Testing, and Maintenance
(<https://www.wbdg.org/ffc/dod/unified-facilities-criteria-ufc>) (26-1.j)
- k. UFGS 14 21 13, Electric Traction Freight Elevators
(<https://wbdg.org/ffc/dod/unified-facilities-guide-specifications-ufgs>) (26-1.k)
- l. UFGS 14 21 23, Electric Traction Passenger Elevators
(<https://wbdg.org/ffc/dod/unified-facilities-guide-specifications-ufgs>) (26-1.l)
- m. UFGS 14 24 13, Hydraulic Freight Elevators
(<https://wbdg.org/ffc/dod/unified-facilities-guide-specifications-ufgs>) (26-1.m)
- n. UFGS 14 24 23, Hydraulic Passenger Elevator
(<https://wbdg.org/ffc/dod/unified-facilities-guide-specifications-ufgs>) (26-1.n)
- o. UFGS 22 15 14.00 40, General Service Compressed Air Systems, Low Pressure (<https://wbdg.org/ffc/dod/unified-facilities-guide-specifications-ufgs>) (26-1.o)
- p. UFGS 22 15 26.00 20, High and Medium Pressure Compressed Air Piping
(<https://wbdg.org/ffc/dod/unified-facilities-guide-specifications-ufgs>) (26-1.p)
- q. UFGS 31 63 26, Drilled Caissons
(<https://wbdg.org/ffc/dod/unified-facilities-guide-specifications-ufgs>) (26-1.q)
- r. UFGS 31 68 13, Soil and Rock Anchors
(<https://wbdg.org/ffc/dod/unified-facilities-guide-specifications-ufgs>) (26-1.r)

- s. UFGS 41 24 26, Hydraulic Power Systems
(<https://wbdg.org/ffc/dod/unified-facilities-guide-specifications-ufgs>) (26-1.s)
- t. 29 CFR 1910.22, General Requirements
(<https://www.govinfo.gov/content/pkg/CFR-2020-title29-vol5/pdf/CFR-2020-title29-vol5-sec1910-22.pdf>) (26-1.t)
- u. 29 CFR 1910.1020, Access to Employee Exposure and Medical Records
(<https://www.govinfo.gov/content/pkg/CFR-2020-title29-vol6/pdf/CFR-2020-title29-vol6-sec1910-1020.pdf>) (26-1.u)
- v. 29 CFR 1926.55, Gases, Vapors, Fumes, Dusts, and Mists
(<https://www.govinfo.gov/content/pkg/CFR-2020-title29-vol8/pdf/CFR-2020-title29-vol8-sec1926-55.pdf>) (26-1.v)
- w. 29 CFR 1926.1052, Stairways
(<https://www.govinfo.gov/content/pkg/CFR-2020-title29-vol8/pdf/CFR-2020-title29-vol8-sec1926-1052.pdf>) (26-1.w)
- x. 29 CFR 1926.1413, Wire Rope Inspections
(<https://www.govinfo.gov/content/pkg/CFR-2020-title29-vol8/pdf/CFR-2020-title29-vol8-sec1926-1413.pdf>) (26-1.x)
- y. 29 CFR 1926 Subpart D, Occupational Health and Environmental Controls
(<https://www.govinfo.gov/content/pkg/CFR-2020-title29-vol8/pdf/CFR-2020-title29-vol8-part1926-subpartD.pdf>) (26-1.y)
- z. 29 CFR 1926 Subpart F, Fire Protection and Prevention
(<https://www.govinfo.gov/content/pkg/CFR-2020-title29-vol8/pdf/CFR-2020-title29-vol8-part1926-subpartF.pdf>) (26-1.z)
- aa. 29 CFR 1926 Subpart K, Electrical (<https://www.govinfo.gov/content/pkg/CFR-2020-title29-vol8/pdf/CFR-2020-title29-vol8-part1926-subpartK.pdf>) (26-1.aa)
- bb. 29 CFR 1926 Subpart M, Fall Protection
(<https://www.govinfo.gov/content/pkg/CFR-2020-title29-vol8/pdf/CFR-2020-title29-vol8-part1926-subpartM.pdf>) (26-1.bb)
- cc. 29 CFR 1926 Subpart S, Underground Construction, Caissons, Cofferdams and Compressed Air (<https://www.govinfo.gov/content/pkg/CFR-2020-title29-vol8/pdf/CFR-2020-title29-vol8-part1926-subpartS.pdf>) (26-1.cc)
- dd. 29 CFR 1926 Subpart U, Blasting and the Use of Explosives
(<https://www.govinfo.gov/content/pkg/CFR-2020-title29-vol8/pdf/CFR-2020-title29-vol8-part1926-subpartU.pdf>) (26-1.dd)

ee. 30 CFR Part 49, Mine Rescue Teams (<https://www.govinfo.gov/content/pkg/CFR-2020-title30-vol1/pdf/CFR-2020-title30-vol1-part49.pdf>) (26-1. ee)

ff. 30 CFR Part 57, Safety and Health Standards for Underground Metal and Nonmetal Mines (<https://www.govinfo.gov/content/pkg/CFR-2020-title30-vol1/pdf/CFR-2020-title30-vol1-part57.pdf>) (26-1. ff)

26-2. Definitions.

a. Authorized Entrant (underground construction). An individual who has completed the requisite training (see para 26-3.a), is wearing appropriate PPE, and has been given permission by the employer to perform duties underground. (26-2.a)

b. Caisson. A wood, steel, concrete, or reinforced concrete, air and watertight chamber in which it is possible to work under air pressure greater than atmospheric pressure to excavate material below water level. (26-2.b)

c. Competent Person (CP). See paragraphs 1-2 or 2-2, as applicable. (26-2.c)

d. Designated Person. An employee who has been trained or is qualified and assigned the responsibility to perform a specific task. (26-2.d)

e. Drilling Fluid. An engineered fluid that is pumped into a drilled hole and used to wash cuttings from the hole. Drilling mud is a type of drilling fluid made of a slurry of clay or polymers and water that is used to coat and support the sides of the drill hole and seal off permeable strata. (26-2.e)

f. Face. The advance end or wall of a tunnel, drift, or other excavation where work is progressing. (26-2.f)

g. Heading. A wall of unexcavated rock at the advance end of a tunnel. Also used to designate either a small tunnel or a small tunnel driven as a part of a larger tunnel. (26-2.g)

h. Hoist. A machinery unit that is used for lifting or lowering a freely suspended (unguided) load. (26-2.h)

i. Jumbo. A movable machine containing working platforms and drills, used for drilling rocks and loading blast holes, scaling the face, or performing other work related to excavation. (26-2.i)

j. Qualified Person (QP), Underground Construction. One, who by possession of a recognized degree, certificate, or professional standing, or extensive knowledge, training, and experience, has successfully demonstrated the ability to solve or resolve problems related to the subject matter, the work, or the project. A typical QP for this

paragraph is an RPE, Geotechnical Engineer, Mining Engineer or Engineering Geologist certified or licensed as required by the AHJ for the site location. The term "Qualified Person (QP)," as used in this chapter refers to "Qualified Person, Underground Construction." (26-2.j)

k. Scaling. The removal of loose, overhanging, protruding, or otherwise precariously positioned material from above or along the sides of an excavation. (26-2.k)

l. Shaft. A passage made from the surface of the ground to a point underground that cuts through the ground at an angle greater than 20° to the horizontal. (26-2.l)

m. Spring Line. The point where the curved portion of the roof meets the top of the wall. In a circular tunnel, the spring lines are at opposite ends of the horizontal center line. (26-2.m)

n. Tunnel. An excavation beneath the surface of the ground, the longer axis of which makes an angle not greater than 20° to the horizontal. (26-2.n)

o. Tunnel Boring Machine (TBM). A machine that excavates a tunnel by drilling out the heading to full size in one operation. May also be referred to as a 'mole'. The TBM is typically propelled forward by jacking off the excavation supports emplaced behind it or by gripping the side of the excavation. (26-2.o)

26-3. Personnel Required Qualification/Training.

a. Authorized Entrants. Authorized Entrants must receive safety instruction in the recognition and avoidance of hazards associated with underground construction according to 29 CFR 1926.800 (29 CFR 1926 Subpart S), including all relevant plans according to paragraph 26-7. (26-3.a)

b. Designated Persons. Designated Persons must: (26-3.b)

(1) Receive Authorized Entrant training and be thoroughly familiar with the check-in and check-out system used at the site.

(2) Know how to activate the Rescue Team and other emergency services in the event of any emergency.

(3) Have a thorough understanding of the lighting, ventilation, communication, and any other life safety related systems and be able to take appropriate action in the event of any failure.

c. Rescue Team. Rescue Team personnel must be familiar with the site, kept up to date on current operations that may impact their response plan, and be fully trained

according to NFPA-1006 or an equivalent standard acceptable to the USACE supervisor/KO or COR. (26-3.c)

26-4. Roles and Responsibilities.

a. Designated Persons. The Designated Person is responsible for keeping an accurate accounting of employee's underground and promptly summoning aid in case of an emergency. They must remain above ground near the entrance at all times and must not be so busy with any other functions that these duties are encumbered. List exact duties in the site-specific APP, AHA, or equivalent documentation. (26-4.a)

b. Qualified Person (QP). (26-4.b)

(1) A QP must conduct inspections of the work site to ensure that any geology-related conditions are anticipated, recognized, evaluated, and corrected before they may present a hazard to occupants or property. The scope and frequency of these inspections must be included in the site-specific APP, or equivalent plan, and amended as necessary to ensure adequacy whenever conditions or work processes change.

(2) A QP must design or review all ground support systems, shoring, roof support systems, excavation methods, and rock bolt support systems.

(3) A QP must inspect underground supports in the blast area after each blast according to paragraph 29-8.h.

(4) A QP must prepare a Contingency Response Plan (CRP) plan according to paragraph 26-7.c.

(5) A QP must inspect air monitoring devices according to paragraph 26-5.a.

c. Competent Person (CP). (26-4.c)

(1) A CP is responsible for ensuring air quality meets the requirements in chapter 6 of this manual. Perform personnel and area air sampling for all contaminants realistically expected to be potentially present where personnel are working. Perform sampling at sufficient frequencies to ensure that conditions and exposures are well characterized. Any changes required in safety controls revealed by this data must be promptly addressed and implemented. The CP must have the authority to coordinate with the Designated Person to stop work and evacuate the work site when dangerous levels exceeding any IDLH or LEL thresholds are encountered.

(2) Conduct inspections of the roof, face, and walls of tunnels according to paragraph 26-5.e.

(3) Inspect and test ventilation systems according to paragraph 26-5.a.

d. Equipment Operator. Inspect equipment according to paragraph 26-5.a.
(26-4.d)

e. Electricians. Inspect trucks used for underground transportation of explosives according to paragraph 26-5.c. (26-4.e)

f. An IH or specially trained CP must perform a review of the jobsite and worker activities when the tasks involve ergonomics-related risk factors, such as awkward postures, exposure to physical hazards, such as excessive vibration or noise, thermal stress, or exposure to fluids, including water. Address and mitigate the hazards to the greatest practical extent. (26-4.f)

26-5. Inspection Requirements.

a. Equipment. (26-5.a)

(1) The operator must inspect equipment that is powered or is important for life safety before use and at the beginning of every shift. This includes guards, shut-off switches, lighting, and other safety equipment. Equipment must not be operated if guards, interlocks, safety switches, or other safety features are inoperable or have been modified.

(2) Rescue Equipment. Conduct and document monthly inspections and workability tests of rescue equipment.

(3) Drilling Equipment. Periodically inspect drilling equipment, drift, and direction to assess if the work area or ground conditions have become unstable.

(4) Inspect rigging according to chapter 15 and 29 CFR 1926.1413.

(5) A CP must inspect and test ventilation systems according to the Ventilation and Dust Control Plan (see para 26-7.e).

(6) A QP must inspect air monitoring devices according to the manufacturer's instructions.

b. Pneumatic Lines. Routinely inspect hydraulic and pneumatic lines according to the manufacturer's instructions or the most applicable reference listed in paragraph 26-5. Remove any damaged or defective lines from service. (26-5.b)

c. Electrical Hazards. Electricians must inspect trucks used for the underground transportation of explosives for electrical system hazards such as stray currents. Auxiliary lights on truck beds that are powered by the truck's electrical system are not permitted. Keep the most recent written record of such inspections inside the vehicle and available for review. (26-5.c)

d. Ground Conditions. A QP must inspect ground conditions along underground haulways and accessways before initial entry by Authorized Entrants. The inspection frequency is as specified in the site-specific APP or equivalent documentation and must be modified whenever changes that may affect stability are encountered, or when warranted by a change in the construction methods being used. (26-5.d)

e. Tunnels. A CP must inspect the roof, face, and walls of the work area at the start of each shift and as often as necessary to determine the stability of the tunnel and adequate protection from falling material. (26-5.e)

f. Blasting. A QP must inspect the underground supports in the blast area after each blast according to paragraph 29-8.h. (26-5.f)

26-6. Activity Hazard Analysis (AHA) Requirements.

Develop AHAs according to paragraphs 1-6 or 2-6, as applicable, to include the following:

a. The AHA for powered equipment must include all aspects required to safely operate the equipment in an underground environment. For equipment that will only be operated by specifically trained and authorized personnel, this requirement may be met if adequately covered in their PHA. Address inherent crushing, caught between, and engulfment hazards for large and heavy equipment operations. (26-6.a)

b. Include in site-specific AHAs potential water related occupational health considerations such as hypothermia, tissue damage from chronic immersion, the growth of potentially pathogenic bio-organisms, and BBP exposure due to sewage. (26-6.b)

26-7. Minimum Plan Requirements.

a. Specific plans required for any work covered in this paragraph must contain the following information in addition to the other requirements listed for the specific plan. (26-7.a)

- (1) Detailed Description of Task.
- (2) Anticipated Hazards.
- (3) Personnel Required Training/Qualification.
- (4) Personnel Roles and Responsibilities.
- (5) Inspection Requirements.

b. Compressed Air Work Plan (CAWP). A CAWP is required when compressed gases are used on a project or when gas cylinders are used or stored at the project site for more than 24 hours. Include the following considerations in the CAWP: (26-7.b)

- (1) Medical lock and operation requirements.
- (2) Compressed air workers identification system.
- (3) Communications system requirements.
- (4) Signs and recordkeeping requirements.
- (5) Special compression and decompression requirements.
- (6) Personnel lock and decompression chamber requirements.
- (7) Compressor systems and air supply requirements.
- (8) Ventilation requirements.
- (9) Electrical power requirements.
- (10) Sanitation considerations.
- (11) Fire prevention and fire protection considerations.
- (12) Bulkheads and safety screens requirements.

c. Contingency Response Plan (CRP). A CRP is required when it is anticipated that the construction of underground tunnels, shafts, chambers, passageways, or other structures covered under this paragraph will impact existing structures or facilities. A QP must prepare the plan and must address, at a minimum, the following: (26-7.c)

- (1) Project overview, background, and need for a CRP.
- (2) Interactions or stability of soil and/or rock masses.
- (3) Hydraulic and hydrogeological impacts.
- (4) Vibration induced impacts.
- (5) Monitoring systems.
- (6) Alert criteria and alarm levels.
- (7) Contingency response required when alert criteria and alarm levels are reached.

d. Emergency Rescue Plans and Equipment. Provide emergency equipment specified in the plan within 15 minutes travel time of each portal or shaft entry.

Emergency rescue plans and equipment must be carefully detailed and must include the following considerations: (26-7.d)

- (1) Primary and backup means of activation.
- (2) Primary and backup means of communication.

e. Ventilation and Dust Control Plan. Develop and implement a Ventilation and Dust Control Plan for every underground construction project. The plan must adequately detail how acceptable breathing air quality will be maintained while also addressing specific controls for any particulate and gaseous contaminants present and must be amended accordingly. At a minimum it must include the following: (26-7.e)

- (1) Site-specific work practices that will be implemented.
- (2) Equipment required, including material and performance specifications.
- (3) Methods and frequency to confirm proper operation.
- (4) Controls required to mitigate special hazards (for example, use of water when drilling, cutting, or grinding rock, concrete, or masonry, and measures to comply with the silica exposure requirements of 29 CFR 1926.55).

f. Fire Prevention and Protection Plan. Develop and implement a Fire Prevention and Protection Plan for every underground construction project according to chapter 9. All affected personnel must review the plan as often as is necessary for them to maintain a working knowledge of emergency responsibilities and procedures. The plan must address the following: (26-7.f)

- (1) Inspection requirements according to UFC 3-601-02.
- (2) Specific work practices and controls to be implemented for fire prevention.
- (3) Response measures taken to control and extinguish any fire that may occur.
- (4) Requirements for daily and weekly fire prevention and protection inspections.
- (5) The frequency of drills and training required to ensure continuous efficacy.

26-8. General Requirements.

Paragraph 26-8 applies to the construction of underground tunnels, shafts, chambers, and passageways. Paragraph 26-8 also applies to cut-and-cover excavations which are both physically connected to ongoing underground construction operations within the scope of this paragraph and covered in such a manner as to create conditions characteristic of underground construction.

a. Access and Egress. The Designated Person is responsible for controlling the access to all underground openings to prevent unauthorized entry. Authorized Entrant access must be coordinated and controlled according to OSHA requirements. Establish worker documentation procedures and a check-in/check-out system according to 30 CFR 57.11058. (26-8.a)

b. Tunneling in Soil. (26-8.b)

(1) Where tunnels are excavated by conventional methods, the excavation must not be extended more than 24 inches (61 cm) ahead of ground supports. Where continuous mining machines are used for tunnel excavation, the excavation must not be extended more than 48 inches (122 cm) ahead of ground supports.

(2) Do not permit under any circumstances persons to work in unsupported sections of the tunnels.

(3) All voids behind ground supports must be filled, blocked, braced, or treated to prevent further cave-ins.

(4) Where liner plate is not used for tunnel support, 2 inches (5.1 cm) wire mesh or chain-link fabric must be installed over the crown section, extending down to the spring line on each side of the tunnel and secured in place.

c. Shafts. (26-8.c)

(1) Shaft Support.

(a) Support all wells or shafts over 5 feet (1.5 m) in depth with lagging, piling, or casing of sufficient strength to withstand shifting of the surrounding earth.

(b) Support the full depth of the shaft by casing or bracing, except where the shaft penetrates into solid rock having characteristics that will not change because of exposure as determined by a QP.

(2) Unsupported Auger-Type Excavations. Do not permit employees to enter an unsupported auger-type excavation in unstable material for any purpose. In such cases, necessary clean-out must be accomplished without entry.

(3) Safe Shaft Access. There must be two safe means of access in shafts at all times. This may include a ladder and hoist.

d. Protection from Falling Material. (26-8.d)

(1) A CP must inspect the roof, face, and walls of the work area at the start of each shift and as often as necessary to determine the stability of the tunnel and adequate protection from falling material.

(2) Rock masses separated from the main mass by discontinuities must be secured by rock bolting, other suitable means, or must be removed. A geotechnical engineer, structural engineer or other QP must design the means of securing the rock masses.

(3) Provide anchored chain-link fabric, or other method approved by the USACE supervisor or accepted by the KO or COR, on rock faces subject to spalling.

(4) Where tunnels are excavated through earth or shale, any excavation above or adjacent to portal areas must be sloped to the angle of repose or held in place by ground supports. When undercutting occurs on these slopes, whether due to erosion or other causes, the overhanging material must be promptly removed.

(5) Provide a protective shelter at each underground portal to protect persons and equipment from the hazards of falling rock or other material, when necessary. The protective shelter must be made of sufficiently durable and strong material and sized appropriately based on work site conditions and risk. This determination must be documented in a site-specific APP, or equivalent document.

(6) Promptly remove ice or snow buildup on rock faces or earth slopes that create a hazard.

e. Ground Support Systems. A QP must design or review all ground support systems, shoring, roof support systems, excavation methods, and rock bolt support systems. Provide suitable protection for employees exposed to the hazard of loose ground while installing ground support systems. (26-8.e)

f. Hoisting. Hoist ways may be used to hoist materials or personnel, but not both simultaneously. (26-8.f)

g. Material Handling Equipment. (26-8.g)

(1) Mount a revolving, flashing amber light on all vehicles and mobile equipment required to move in and out of underground construction areas. Mount the light so that it is visible in all directions and must be operational whenever the vehicle or mobile equipment is in operation.

(2) Equip haulage equipment with two headlights at both ends, a back-up light, and an automatic back-up alarm.

(3) Where narrow-gage railroads are used for haulage, the tracks must be secured to prevent shifting. No "humping" of mine dump cars will be permitted.

(4) Locomotives and mine dump cars must be equipped with automatic safety couplings, and cradle cars must be equipped with a positive locking device to prevent accidental dumping.

(5) Do not operate haulage equipment at a speed that will endanger any employee.

(6) Operators must ensure that a clear line of sight exists to the entire area where a load will be dumped, directly or via a spotter that has coordinated clearance requirements and communication methods with the operator before dumping loads. All other personnel must remain clear of this area until dumping is completed, and the operator signals that access can be resumed.

(7) Keep vehicles not directly involved in work away from portals and separated from construction activities.

(8) Conveyors used to transport muck from tunnels must be installed, guarded, and maintained according to chapter 14. Provide fire extinguishers or equivalent protection at the head and tail pulleys of underground belt conveyors and at 300 feet (91.4 m) intervals along the belt line.

h. Waterborne Safety and Flood Prevention. (26-8.h)

(1) Water discharged from any underground or construction site must be tested and treated to ensure that it meets EPA NPDES and local authority discharge requirements, as appropriate.

(2) When the potential exists, water must be tested to ensure that it contains no hazards that may expose workers above any OELs according to chapter 6 of this manual.

(3) Take measures to prevent flooding whenever openings are located adjacent to sources of water that may cause flooding in the underground work area.

(4) Personnel working in wet underground areas must wear rubber boots and rain gear, as necessary.

i. Compressed Air Work. Perform work in compressed air environments according to 29 CFR 1926.803 (29 CFR 1926 Subpart S), to include development of a CAWP according to paragraph 26-7.b. (26-8.i)

j. Drilling. Drilling operations in this paragraph are described for activities relating to underground construction and include drilling associated with exploratory borings, blasting, ventilation, and access shafts. For drilling associated with other operations, such as wells, geotechnical studies, and soil studies, see chapter 18. (26-8.j)

(1) Drilling Area Preparation.

(a) Clear the drilling location of utilities in advance of drilling operations. Utilities in the area must be identified and marked prior to performing intrusive operations.

Drilling from surface locations may require clearance of overhead utilities. The mast or boom must be clear of overhead obstructions in all operational positions.

(b) Prepare the drilling surface to receive drilling tools. Clear loose material, scale, and other obstructions in advance of stationing the drilling equipment according to 29 CFR 1910.22.

(c) Place drill rigs and jumbos on stable and level surfaces to the extent possible. Drilling equipment that must be placed on sloping or unstable surfaces requires anchorage, outriggers, blocking, or construction of drilling platforms.

(c-1) All anchorage and blocking must be sufficient to maintain boring direction and stability of the equipment and working compartments or platforms. All elevated work platforms must comply with this manual, 29 CFR 1926 Subpart M and 29 CFR 1926.1052.

(c-2) Periodically inspect drilling equipment, drift, and direction to assess if the work area or ground conditions have become unstable. The work platform, blocking, or anchorage must be adjusted as necessary to maintain work area stability.

(2) Drilling Equipment Movement.

(a) Secure heavy equipment, drill masts, rigging, outriggers, pipe, and compartments prior to movement.

(b) Movement of drill rigs, jumbos, and other heavy equipment must be performed with personnel located only in covered or otherwise protected operator compartments and not located on surfaces or in compartments that are not designed for occupancy during travel.

(c) Personnel must be clear of the anticipated travel path. Spotters may be required to properly position equipment. Spotters must be positioned out of the direct travel pathway to the extent practicable.

(3) Jumbos.

(a) Provide safe access to all working levels of drill jumbos.

(b) Design and secure jumbo decks and stair treads to be slip-resistant and to prevent accidental displacement.

(c) Only employees assisting the operator will be allowed to ride on jumbos unless the jumbo is designed for passengers. The design must include adequate seating arrangements that protect passengers from being struck, crushed, or caught between equipment and surfaces, and must permit safe access.

(d) Notify employees working under jumbo decks whenever drilling is about to begin.

(e) On jumbo decks over 6 feet (1.8 m) in height where there is no adjacent surface that provides fall protection, install removable guardrails or equivalent protection on all open sides, excluding access openings of platforms (see chapter 21).

(f) Stair access to jumbo decks over 10 feet (3 m) in height must be wide enough to accommodate two persons.

(g) Provide receptacles or racks for drill steel stored on jumbos.

(h) The employer must provide mechanical means for lifting drills, roof bolts, mine straps, and other material to the top decks of jumbos over 10 feet (3 m) in height.

(4) Borehole Advancement and Casing.

(a) Barricade or otherwise protect accessible areas within the swing radius of the equipment's rotating superstructure to prevent an employee from being struck or crushed by the equipment.

(b) Ensure that personnel are guarded or kept a safe distance from rotating drill pipe, bits, collars, rod, and casing during operation. Operate the equipment from the cabin or in working platforms to the extent possible. Take additional precautions to protect personnel located within swing radius of articulating booms, tooling, or rigging, or within an area located where cuttings or drilling fluids accumulate. Additional precautions include having a safe egress/escape route, maintaining direct visual, verbal, or radio communication between equipment operators and personnel working within the vicinity, and wearing high visibility clothing.

(c) Handle and lift drill rods, pipe, casing, and other down-hole tooling based on the size and weight of the tooling and in a manner that reduces struck-by and lifting hazards.

(c-1) Move heavy pipe, rods, or tooling using mechanical equipment if the size and shape of the equipment is not safe for manual handling.

(c-2) Rigging must be inspected and appropriately sized in according to 29 CFR 1926.1413.

(c-3) Couple and decouple drill string tooling, drill rod, drill pipe, and casing with the equipment secured and with minimum movement of the equipment. Ensure that personnel keep a safe distance between hydraulically actuated or mechanized clamps, tongs, jacks, pipe stabber, pipe spinner, and rotating parts. Maintain drill rod, pipe, casing, and tooling in secure racks or compartments when not in use.

(d) Manage drilling fluids and cuttings to maintain borehole stability, jumbo or drill rig stability, and to prevent pressure releases that may damage equipment or injure personnel.

(d-1) Do not allow drilling fluids and cuttings to clog equipment lighting, safety devices, or guards, or to create obstructions in personnel or equipment travel paths.

(d-2) Secure drill fluid hoses, pipe, and tooling from whipping hazards and place them where they can be inspected for wear and leaks.

(d-3) Do not manually clear clogged fluid pipes, hoses, casing, or drill pipe unless the equipment can be safely depressurized and when access by personnel does not require entry into the borehole.

(d-4) Locate, to the extent possible, accumulation areas for cuttings and drilling fluids away from drilling equipment and personnel. Maintain drill fluid circulation equipment and pumps free of damage and be readily available for inspection during operation. Containerize or stockpile cuttings in a manner that does not create work area obstructions, or trip, air quality or engulfment hazards.

(e) Perform casing or securing of a boring or drill area with equipment that is selected to withstand the loads expected for that area.

(e-1) Temporary borehole casing may be placed with percussive methods only when such methods are not expected to destabilize working areas.

(e-2) Place casing jacks in level and stable areas that will not de-stabilize the rock face, drill rig or jumbo footings, or personnel work areas. Personnel must not place hands on the jacks when in operation.

(e-3) Perform permanent installation of conductor or borehole casing with concrete or other sealing media that will prevent leakage or de-stabilization by drilling fluids, circulated air, muck, or cuttings.

(5) Drilling After a Blast. Before commencing the drill cycle after a blast, examine the face and any remaining blasting holes for misfires. Remove the misfire prior to continuing drilling operations.

k. Electrical and Lighting. See chapter 7 for lighting and chapter 11 for electrical.
(26-8.k)

(1) Install lighting circuits on one side of the tunnel near the spring line and mount the cables on insulators at each point of suspension.

(2) Properly design and maintain all electrical and lighting systems. Use only nonmetallic and waterproof fixtures mounted in a manner that provides safe clearance for personnel and equipment.

(3) Protect personnel from potential lighting hazards such as thermal burns and optical discomfort. Remove unused lighting and systems from the work area when no longer needed.

(4) All personnel working underground must carry functional lighting devices on their person to help locate the backup area emergency lighting devices or to facilitate their safe egress.

I. Fire Prevention and Protection. (26-8.l)

(1) Fire Extinguishers.

(a) Provide and maintain fire extinguishers according to chapter 9, to include necessary training requirements.

(b) Provide and maintain fire extinguishers, or equivalent protection, at each portal and shaft entry, within 100 feet (30.5 m) of the face of each tunnel, and at locations containing combustible materials.

(2) Within tunnels, use only heating devices approved for such locations by an NRTL.

(3) Only combustible materials similar to diesel fuel or approved welding/cutting gases may be stored underground. Store no more than a one-day supply of these combustible materials. Never store flammable products such as Liquefied Petroleum Gas or gasoline underground. Never pipe flammable or combustible materials from the surface to underground locations.

(4) Hazardous Classifications. Obtain a hot work permit according to paragraph 9-8.g and maintain a fire watch, according to paragraph 9-8.g, when hot work is performed, or an area is designated as a gassy operation.

m. Ventilation. (26-8.m)

(1) Provide ventilation and exhaust systems for tunnel excavation with sufficient capacity to maintain an adequate supply of uncontaminated air at all points in the tunnel. Use only mechanical ventilation. Do not use natural ventilation.

(2) Supply at least 200 CFM (94 Liters per second) of fresh air for each employee underground. Supply additional air necessary to operate the equipment.

(3) Do not use air that has passed through underground oil or fuel-storage areas or any other hazardous atmosphere to ventilate work areas. Design the ventilation system to exhaust from these spaces via ducting that is properly rated for this service.

(4) The USACE supervisor/KO or COR must review the ventilation system and performance, flow rates, and volumes before acquiring or installing the system or any components. After installation a CP must inspect and test the system as stated in the Ventilation and Dust Control Plan (see para 26-7.e). Keep records onsite and readily available for review until project completion.

n. Air Monitoring and Air Quality Standards. (26-8.n)

(1) Air Monitoring Requirements.

(a) A QP must inspect, calibrate, maintain, and use air monitoring devices according to the manufacturer's instructions. Devices must have sufficient limits of detection and resolution and be routinely calibrated to competently detect and display contaminant levels less than or equal to 50% of the applicable OEL.

(b) Maintain a record of all air quality tests above ground at the work site and make them available to any USACE supervisor/KO or COR upon request. Record the location, date, time, substance(s) monitored, applicable limits, monitoring results, and name of person conducting the test. Also record the instrument specific data such as serial number, calibration date, bump test results, etc. If the calibration or bump test information is recorded in a different record such as in an automated system, ensure both records contain a unique identifier that will link them. Retain records of personnel exposure to toxic substances according to 29 CFR 1910.1020. Maintain all air quality test records at the jobsite until completion of the project and according to DoD, U.S. Army, and USACE policies. Records of personal monitor results, used in addition to other devices and intended only to alert personnel directly, do not need to be maintained, however, the calibration, bump test, and other pertinent information must be recorded.

(2) Air Quality Standards.

(a) Implement appropriate control strategies to ensure that the 8-hour TWA personal exposures will be maintained below the most restrictive OEL according to 29 CFR 1926.55, or as referenced in chapter 6 of this manual. Perform monitoring prior to routine entry by other Authorized Entrants and at frequencies dictated in other regulations or site-specific policies. Perform routine monitoring at least once each shift in stable environments and more often when conditions are realistically expected to change. Continuous monitoring is preferred. The site-specific policies and procedures must be updated to reflect current site conditions.

(b) The OELs for some contaminants required to be monitored by 29 CFR 1926.800 (29 CFR 1926 Subpart S) (that is, hydrogen sulfide and nitrogen

dioxide) are near the detection limitations of commercially available instrumentation. This makes them more prone to statistical fluctuations and cross sensitivities that could cause false alarms if the TWA OEL were used as the alarm set points. It is permissible to use the short-term exposure limit or ceiling limits as alarm set points in lieu of the TWA limits, as long as compliance with the TWA is assured and personnel are trained to promptly evacuate when these levels are reached.

26-9. Figures and Tables.

Not Applicable.

26-10. Checklists and Forms.

Not Applicable.

Chapter 27

Concrete, Masonry, Roofing, and Wood Construction

27-1. References.

- a. American Concrete Institute (ACI) 347R-14, Guide to Formwork for Concrete (<https://www.concrete.org>) (27-1.a)
- b. ANSI/ASSP A10.34, Protection of the Public on or Adjacent to Construction Sites (<https://webstore.ansi.org/>) (27-1.b)
- c. Department of Transportation (DOT) Federal Highway Administration's "Manual on Uniform Traffic Control Devices" (MUTCD) (<https://mutcd.fhwa.dot.gov>) (27-1.v)
- d. Mason Contractors Association of America (MCAA), Standard Practice for Bracing Masonry Walls Under Construction (<https://www.masoncontractors.org>) (27-1.d)
- e. OSHA Technical Manual (OTM) Section V: Chapter 2, Excavations: Hazard Recognition in Trenching and Shoring (<https://www.osha.gov/otm/section-5-construction-operations/chapter-2>) (27-1.e)
- f. 29 CFR 1926 Subpart Q, Concrete and Masonry Construction (<https://www.govinfo.gov/content/pkg/CFR-2020-title29-vol8/pdf/CFR-2020-title29-vol8-part1926-subpartQ.pdf>) (27-1.f)

27-2. Definitions.

- a. Construction Loads. Those loads imposed on a partially completed or temporary structure during and as a result of the construction process. Construction loads include, but are not limited to, materials, personnel, and equipment imposed on the temporary or permanent structure during the construction process. (27-2.a)

b. Limited Access Zone. An area alongside a masonry wall, which is under construction, and which is clearly demarcated to limit access by employees. (27-2.b)

c. Reshoring. The construction operation in which shoring equipment (that is, reshores or reshoring equipment) is placed as the original forms and shores are removed. The reshoring supports partially cured concrete and construction loads. (27-2.c)

d. Restricted Zone. The area on each side of a wall subject to the effect of a masonry wall collapse, measured by a horizontal distance equal to the height of the constructed wall plus 4 feet, measured at right angles to the wall, and continuing for the length of the wall plus a minimum of 4 feet beyond the ends of the wall. (27-2.d)

e. Shore. A supporting member (for example, false work to support an elevated concrete deck pour) that resists a compressive force imposed by a load. See OSHA Technical Manual (OTM) Section V: Chapter 2, Section VII Shoring Types for examples of shore types. (27-2.e)

f. Tremies. Pipe through which concrete may be deposited under water. (27-2.f)

g. Vertical Slip Forms. Forms which are jacked or hoisted vertically during the placement of concrete. (27-2.g)

27-3. Personnel Required Qualification/Training.

Not Applicable.

27-4. Roles and Responsibilities.

a. Competent Person (CP). (27-4.a)

(1) Oversee the removal of plumb-up guys for structural and reinforcing steel according to paragraph 27-8.c.

(2) Determine if concrete has gained sufficient strength prior to removal of formwork and shoring according to paragraph 27-8.e.

(3) Supervise the repairs of any damaged or weakened masonry bracing elements according to paragraph 27-8.g.

(4) Inspect unsupported masonry walls according to paragraph 27-5.b.

b. Qualified Person (QP). (27-4.b)

(1) Prepare plans according to paragraph 27-7.

(2) Determine restricted zone for multi-story structures according to paragraph 27-8.g.

(3) Conduct a structural analysis of the roofs according to paragraph 27-8.h(1).

c. Registered Professional Engineer (RPE). (27-4.c)

(1) Plan and design vertical slip forms according to paragraph 27-8.e(8).

(2) Design independent reinforcing steel support systems according to paragraph 27-8.c.

(3) Design single post shores according to paragraph 27-8.e(5).

(4) Inspect erected shoring systems according to paragraph 27-5.

(5) Design repairs do damaged masonry walls according to paragraph 27-8.g.

(6) Design wood type construction according to paragraph 27-8.i.

27-5. Inspection Requirements.

a. Formwork and Shoring. (27-5.a)

(1) An RPE qualified in structural design must inspect shoring equipment prior to erection to determine that it is as specified in the shoring design. Do not use any damaged equipment.

(2) Inspect erected shoring equipment immediately prior to, during, and immediately after the placement of concrete. Immediately reinforce or re-shore any shoring equipment that is found to be damaged, displaced, or weakened.

(3) Whenever single post shores are used in more than one tier, the layout must be inspected by a structural engineer.

b. Masonry Construction. Unsupported masonry walls, including the wall bracing system, must be inspected by a CP at the beginning of each shift and after any occurrence that could affect the structural integrity of the wall or wall bracing system. (27-5.b)

27-6. Activity Hazard Analysis (AHA) Requirements.

Develop AHAs according to paragraphs 1-6 or 2-6, as applicable.

27-7. Minimum Plan Requirements.

a. Erection and Removal Plan for Formwork and Shoring. An erection and removal plan for formwork and shoring is required for all formwork other than slab on grade. The plan must be developed by a QP from the approved formwork and shoring design, updated as conditions change, and submitted to the USACE supervisor for approval or to the KO or COR for acceptance. The plan must include the following: (27-7.a)

(1) Detailed description of the work being performed to include the sequence of erection and removal activities and site preparation and control.

(2) Description of the anticipated hazards or concerns and the control measures that will be implemented to control to an acceptable level.

(3) Procedures for material deliveries, storage, staging and removal.

(4) Procedures for determining if concrete has reach sufficient strength to begin removal of formwork and shoring.

(5) A list of the QPs and CPs to include their roles and responsibilities under the plan.

(6) Inspection and oversight methods to ensure adherence to the plan.

b. Precast Concrete Plan. A precast concrete plan is required prior to the erection of any precast concrete. The plan must be developed and signed by a QP, updated as conditions change, and submitted to the USACE supervisor for approval or to the KO or COR for acceptance. The plan must include the following: (27-7.b)

(1) Detailed description of the work being performed to include the sequence of erection activity and site preparation and control.

(2) Description of the anticipated hazards or concerns and the control measures that will be implemented to control to an acceptable level.

(3) A description of required bracing and placement procedures according to approved fabrication drawings.

(4) Procedures for material deliveries, storage, and staging.

(5) Process for coordination with other trades and ongoing construction activities.

(6) A list of the QPs and CPs to include their roles and responsibilities under the plan.

(7) Inspection and oversight methods to ensure adherence to the plan.

c. Masonry Erection Plan. A masonry erection plan is required prior to the erection of any structural masonry. The plan must be developed and signed by a QP, updated as conditions change, and submitted to the USACE supervisor for approval or to the KO or COR for acceptance. The plan must include the following: (27-7.c)

(1) Detailed description of the work being performed to include the sequence of erection activity and site preparation.

(2) Description of the anticipated hazards or concerns and the control measures that will be implemented to control to an acceptable level to include limited access and restricted zone perimeters.

(3) A description of required bracing selection and placement procedures to include supportive calculation; Stability considerations requiring temporary bracing; Terminus point; and Connections. If bracing is determined to be not required, provide justification.

(4) Procedures for material deliveries, storage, and staging.

(5) Process for coordination with other trades and ongoing construction activities.

(6) A list of the QPs and CPs to include their roles and responsibilities under the plan.

(7) Inspection and oversight methods to ensure adherence to the plan.

27-8. General Requirements.

a. General. (27-8.a)

(1) For all work covered by this chapter, the fall protection threshold height requirement is 6 feet (1.8 m) (see chapter 21).

(2) Do not place construction loads on a structure or portion of a structure unless the employer determines, based on information from a person who is qualified in structural design, that the structure or portion of the structure is capable of supporting the loads.

(3) Do not allow employees to work above or in positions exposed to protruding reinforcing steel, fasteners, or other impalement hazards unless provisions have been made to control the hazard.

(4) Working Under Loads.

(a) Do not allow employees to work under concrete buckets, bundled material loads, or other suspended loads.

(b) To the extent practical, route elevated concrete buckets and loads to minimize the exposure of workers to hazards associated with falling loads or materials from the loads. Keep vibrator crews out from under concrete buckets suspended from cranes or cableways.

(c) Do not allow anyone to ride on concrete buckets or other suspended loads.

(5) Select and use PPE (as necessary for the work activity being performed according to chapter 5.

(6) Where the work activities performed present a potential hazard to the public, set up and maintain barricades with proper postings to alert the public to the hazards according to the MUTCD and ANSI/ASSP A10.34, and any other state or local requirements.

b. Concrete. (27-8.b)

(1) Equipment.

(a) Bulk storage bins, containers, or silos must have conical or tapered bottoms with mechanical or pneumatic means of starting the flow of material.

(b) Equip concrete mixers having a 1 yd³ (0.8 m³) or larger loading skip with a mechanical device to clear the skip of material. Also install guardrails on each side of the skip. (See chapter 21)

(c) Construct the handles on bull floats used where they may contact energized electrical conductors of nonconductive material or insulate them with a nonconductive sheath that provides equivalent protection.

(d) Equip powered and rotating concrete troweling machines that are manually guided with a control switch that will automatically shut off the power whenever the operator removes their hands from the equipment handles.

(e) Concrete buckets equipped with hydraulic or pneumatically operated gates must have positive safety latches or similar safety devices installed to prevent premature or accidental dumping. Design the buckets to prevent material from accumulating on the top and sides of the bucket.

(f) Provide concrete pumping systems using discharge pipes with pipe supports designed for 100% overload.

(g) Concrete buggy handles must not extend beyond the wheels on either side of the buggy.

(h) Secure the sections of tremies and similar concrete conveyances with wire rope or equivalent material in addition to the regular couplings or connections.

c. Structural and Reinforcing Steel. (27-8.c)

(1) Brace, guy, weld, or otherwise support structural and reinforcing steel for walls, piers, columns, and similar vertical structures to prevent overturning or collapse. An RPE must design any support systems for reinforcing steel that are independent of other forms of shoring support systems.

(2) Properly secure all equipment connections used in plumbing-up.

(3) Secure turnbuckles to prevent unwinding while under stress.

(4) Place plumbing-up guys and related equipment so that employees can get at the connection points.

(5) Prevent unrolled wire mesh from recoiling.

d. Post Tension Operations. (27-8.d)

(1) Do not allow employees, except those essential to the post-tensioning operations, to be behind jacks or end anchorages during post-tensioning operations.

(2) Erect signs and barriers to identify and limit employee access to the post-tensioning area during tensioning operations.

e. Formwork and Shoring. (27-8.e)

(1) Formwork and shoring will be designed and planned according to ACI 347R-14 (see para 27-7.a).

(2) Design, fabricate, erect, support, brace, and maintain formwork, shoring, and bracing so that it will safely support all vertical and lateral loads that might be applied until such loads can be supported by the structure.

(3) When fabricated shoring systems are used, keep a copy of the manufacturer's specifications for the system available at the work site during job planning and execution.

(4) Do not use fabricated single post shores or adjusting devices if heavily rusted, bent, dented, re-welded, or have broken welds or other defects. If they contain timber,

they may not be used if the timber is split, cut, has sections removed, is rotted, or is otherwise structurally damaged.

(5) Base Support.

(a) Ensure supporting ground or completed construction upon which formwork and shoring is placed has adequate strength to carry the applied vertical and lateral loads.

(b) Ensure sills for shoring are sound, rigid, and capable of carrying the maximum intended load.

(c) Ensure base plates, shore heads, extension devices, or adjustment screws are in firm contact with the footing sill and form material and when necessary, are secured to them.

(d) Design and construct splices to prevent buckling and bending.

(e) Provide diagonal bracing in vertical and horizontal planes to provide stiffness and to prevent buckling of individual members.

(f) Provide reshoring to safely support slabs and beams after stripping or where such members are subjected to superimposed loads due to construction.

(g) Do not load fabricated shoring beyond the safe working load recommended by the manufacturer.

(6) Single Post Shores.

(a) A structural engineer must design and inspect the layout wherever single post shores are used in more than one tier.

(b) Vertically align single post shores and splice them to prevent misalignment.

(c) When shoring is at an angle, sloping, or when the shored surface is sloping, design the shoring for such loading.

(d) Do not adjust single post shores to raise formwork after the concrete is in place.

(e) Drive home all nails used to secure bracing or adjustable timber single post shores and bend the point of the nail over, if possible (that is, clinch the nails).

(f) For stability, brace single post shores in both the longitudinal and transverse directions.

(f-1) Adequately brace single-post shores in two mutually perpendicular directions at the splice level.

(f-2) Diagonally brace each tier in the same two directions.

(f-3) Install bracing as the shores are erected.

(f-4) Secure posts located near the slab perimeter during assembly and dismantling or reshoring to prevent the post from “fall out”.

(7) Tube and Coupler Shoring.

(a) Use structural type material (for example, drop-forged steel, malleable iron, structural grade aluminum) for the couplers. Do not use gray cast iron or dissimilar metals.

(b) Do not use couplers if they are deformed, broken, or have defective or missing threads on bolts, or have other defects.

(c) When inspecting the erected shoring towers, do not exceed the spacing between posts from that shown on the designed layout drawings. Inspect the interlocking of all tubular members and the tightness of the couplings.

(8) Tubular Welded Frame Shoring.

(a) All locking devices on frames and braces must be in good working order and all components must be in a condition similar to that of original manufacture. Coupling pins must align the frame or panel legs and pivoted cross braces must have their center pivot in place.

(b) Do not exceed the spacing between towers and cross brace spacing from that shown in the design. Ensure all locking devices are closed.

(c) Fasten devices for attaching external lateral stability bracing to the legs of the shoring frames.

(9) Vertical Slip Forms.

(a) Design the steel rods or pipe on which the jacks climb or by which the forms are lifted specifically for that purpose. Brace the rods and pipes where not encased in concrete.

(b) Position jacks and vertical supports so that the vertical loads are distributed equally and do not exceed the capacity of the jacks.

(c) Provide jacks or other lifting devices with mechanical dogs or other automatic holding devices to provide protection in case of failure of the power supply or the lifting mechanism.

(d) Perform lifting steadily and uniformly. Do not exceed the predetermined safe rate of lift.

(e) Provide lateral and diagonal bracing of the forms to prevent excessive distortion of the structure during the jacking operation.

(f) During jacking operations, maintain the form structure in line and plumb.

(g) Provide all vertical lift forms with scaffolding or work platforms completely encircling the area of placement.

(10) Removal of Formwork and Shoring. Do not remove forms or shores, except those on slab on grade and slip forms, until the CP for forming or shoring determines that the concrete has gained sufficient strength to support its weight and all superimposed loads. The CP must base the determination on one of the following:

(a) Satisfaction of conditions stipulated in the plans and specifications for removal of forms and shores.

(b) Concrete testing indicates that the concrete has achieved sufficient strength to support its weight and superimposed loads.

f. Precast Concrete Operations. (27-8.f)

(1) Develop a precast concrete plan prior to beginning any precast placement activities (see para 27-7.b).

(2) Adequately support precast concrete members to prevent overturning or collapse until permanent connections are complete.

(3) Lifting Inserts and Hardware.

(a) Lifting inserts which are embedded or otherwise attached to tilt-up precast concrete members must be capable of supporting at least two times the maximum intended load applied or transmitted to them.

(b) Lifting inserts which are embedded or otherwise attached to precast concrete members, other than tilt-up members, must be capable of supporting at least four times the maximum intended load applied or transmitted to them.

(c) Lifting hardware must be capable of supporting at least five times the maximum intended load applied or transmitted to the lifting device.

(4) Do not allow employee under precast concrete members being lifted or tilted into position except employees required for the erection of those members.

g. Masonry Construction. See MCAA Standard Practice for Bracing Masonry Walls Under Construction. (27-8.g)

(1) Develop a masonry erection plan prior to beginning any structural masonry activities (see para 27-7.c).

(2) Establish a limited access zone whenever a masonry wall is being constructed. The limited access zone must:

(a) Equal the height of the wall plus four feet and run the entire length of the wall.

(b) Be established on the side of the wall which will be unscaffolded.

(c) Be restricted to entry by employees actively engaged in constructing the wall.

(d) Remain in place until the wall is adequately supported to prevent overturning and to prevent collapse unless the height of wall is over eight feet, in which case, a restricted access zone must be established according to paragraph 27-8.g.

(3) Establish a restricted zone whenever a masonry wall over 8' is being constructed. The restricted zone is created to keep masons and other tradesmen away from a wall under construction when winds exceed critical velocities until the wall is completely tied into the rest of the structure. The restricted zone must:

(a) Be established on both sides of wall prior to the start of wall construction.

(b) Be equal to the height of the wall being constructed plus 4 feet (1.2 m) and must run the entire length of the wall plus 4 feet (1.2 m) beyond the ends of the wall.

(c) Be restricted to entry by individuals who have been trained to recognize the hazards associated with working inside the restricted zone and are actively engaged in constructing the wall.

(d) Be evacuated during the initial period of wall construction when wind speeds exceed 20 mph (32.1 km/h).

Note. The initial period is considered the period of time, not to exceed 24 hours, during which the masonry is being laid above its base or highest line of bracing, and at the end of which required bracing is installed.

(e) Be evacuated during the intermediate period of wall construction when wind speeds exceed 35 mph (56.3 km/h).

Note. The intermediate period is considered the period of time following the initial period but before the wall is connected to the elements that provide its final lateral support.

(f) Remain in place until the wall has obtained its final lateral support.

(g) For multi-story structures, a QP must determine the restricted zone.

(4) Adequately brace all masonry walls over 8 feet (2.4 m) in height to prevent overturning and to prevent collapse unless the wall is adequately supported so that it will not overturn or collapse. The bracing must remain in place until permanent supporting elements of the structure are in place.

(5) Repair or replace any damaged or weakened brace elements before work is permitted in the restricted zone in the vicinity of the damaged brace or weakened brace element.

(6) Repairs to damaged walls must be designed by a structural engineer, familiar with the work being performed, and approved by the designer of record before starting the repairs.

(7) Each employer having workers in the restricted zone must monitor the wind speed continuously while the work is in progress and evacuate employees when wind speeds exceed the requirements of paragraphs 27-8.g(3)(d) and 27-8.g(3)(e).

(a) Wind speeds must be 3-second gust speeds.

(b) Instrument methods must accurately measure wind speed to +/- 2 mph (+/- 3.2 km/h). Properly maintain the instruments.

(8) Do not use scaffolds intended for masonry construction workers to provide temporary lateral support of masonry walls.

(9) Locate cleanouts on the side of the masonry wall opposite to the scaffolding.

h. Roofing. (27-8.h)

(1) A QP must conduct a structural analysis of the roof to assure that the load capacity of the roof deck will not be exceeded prior to the start of work.

(2) Stop roof work during severe weather (for example, strong winds, electrical storms, icing conditions, heavy rain, snow) as soon as practical.

(3) Protect roof openings and holes according to chapters 21 and 24.

(4) On all roofs greater than 16 feet (4.9 m) in height, provide a hoisting device, stairways, or progressive platforms when supplying materials and equipment.

(5) Secure all roofing materials and accessories when wind speeds are greater than, or are anticipated to exceed, 10 mph (16.1 km/h). This includes unattached metal roofing panels stored on the roof.

(6) Provide access and egress to and on roofs or roof sections according to chapters 22 and 24, as applicable.

(7) Do not store materials within 6 feet (1.8 m) of the roof edge unless guardrails are erected at the roof edge. Materials that are to be piled, stacked, or grouped must be stable and self-supporting. (See chapters 14 and 19)

(8) Personnel working with hot roofing materials (for example, hot mop roofing bitumen, torch applied roofing membranes) must wear the proper PPE (see chapter 5).

i. Wood Construction. (27-8.i)

(1) All wood used for construction must meet applicable building codes and design criteria. Inspect wood used for temporary work platforms or fall protection for compliance with chapters 21 and 22, since structural lumber from the site may not meet the requirements for protective systems.

(2) Raising Walls.

(a) Before manually raising framed walls that are 10 feet (3 m) or higher, install temporary restraints (for example, cleats on the foundation or floor system, straps on the wall bottom plate) to prevent inadvertent horizontal sliding or uplift of the framed wall bottom plate.

(b) Do not use only anchor bolts for blocking or bracing when raising framed walls 10 feet (3 m) or higher.

(3) Do not allow employees to work from or walk on top plates, joists, rafters, trusses, beams, or other structural members until they are securely braced and supported.

(4) For wood type construction, an RPE must design the truss support plates, required spacing, temporary bracing, and connection details.

27-9. Figures and Tables.

Not Applicable.

27-10. Checklists and Forms.

Not Applicable.

Chapter 28 Steel Erection

28-1. References.

29 CFR 1926 Subpart R, Steel Erection (<https://www.govinfo.gov/content/pkg/CFR-2020-title29-vol8/pdf/CFR-2020-title29-vol8-part1926-subpartR.pdf>)

28-2. Definitions.

a. Anchored Bridging. Steel joist bridging that is connected to a bridging terminus point. (28-2.a)

b. Bolted Diagonal Bridging. Diagonal bridging that is bolted to a steel joist or joists. (28-2.b)

c. Bridging Clip. A device that is attached to the steel joist to allow the bolting of the bridging to the steel joist. (28-2.c)

d. Bridging Terminus Point. A structural element (for example, wall, beam, tandem joists with all bridging installed and a horizontal truss in the plane of the top chord) at an end or intermediate point of a line of bridging that provides an anchor point for the steel joist bridging. (28-2.d)

e. Controlled Decking Zone (CDZ). An area in which certain work (for example, initial installation and placement of metal decking) may take place without the use of guardrail systems, PFAS, fall restraint systems, or safety net systems and where access to the zone is controlled. (28-2.e)

f. Decking Hole. A gap or void more than 2 inches (5.1 cm) in its least dimension and less than 12 inches (30.5 cm) in its greatest dimension in a floor, roof or other walking or working surface. Pre-engineered holes in cellular decking (for example, for wires, cables) are not included in this definition. (28-2.f)

g. Derrick Floor. An elevated floor of a building or structure that has been designated to receive hoisted pieces of steel prior to final placement. (28-2.g)

h. Erection Bridging. The bolted diagonal bridging that is required to be installed prior to releasing the hoisting cables from the steel joists. (28-2.h)

i. Girt (in systems-engineered metal buildings). A "Z" or "C" shaped member formed from sheet steel spanning between primary framing and supporting wall material. (28-2.i)

j. Metal Decking. A commercially manufactured, structural grade, cold-rolled metal panel formed into a series of parallel ribs; this includes metal floor and roof decks, standing seam metal roofs, other metal roof systems, bar gratings, checker plate, expanded metal panels, and similar products. (28-2.j)

k. Multiple Lift Rigging (MLR). A rigging assembly manufactured by wire rope rigging suppliers that facilitates the attachment of up to five independent members of similar structural types spaced at a minimum of 7 feet (2.1 m) apart to the hoist rigging of a crane. (28-2.k)

l. Permanent Floor. A structurally completed floor at any level or elevation, to include slab on grade. (28-2.l)

m. Project Structural Engineer of Record. The RPE responsible for the design of structural steel framing and whose seal appears on the structural design drawings. (28-2.m)

n. Purlin (in systems-engineered metal buildings). A "Z" or "C" shaped member formed from sheet steel spanning between primary framing and supporting roof material. (28-2.n)

o. Snug Tight. A condition that exists when all plies in a connection have been pulled into firm contact by the bolts in the joint and all of the bolts in the joint have been tightened sufficiently to prevent removal of the nuts without the use of a wrench. (28-2.o)

p. Steel Erection. The construction, alteration, or repair of steel buildings, bridges, and other structures, including the installation of metal decking and all planking used during the process of erection. (28-2.p)

q. Steel Joist. An open web, secondary load-carrying member of 144 feet (43.9 m) or less, designed by the manufacturer, that is used for the support of floors and roofs. This does not include structural steel trusses or cold-formed joists. (28-2.q)

r. Steel Joist Girder. An open web, primary load-carrying member, designed by the manufacturer, used for the support of floors and roofs. This does not include structural steel trusses. (28-2.r)

s. Steel Truss. An open web member designed of structural steel components by the project structural engineer of record. A steel truss is considered equivalent to a solid web structural member. (28-2.s)

t. Structural Steel. A steel member, or a member made of a substitute material (for example, fiberglass, aluminum, composite members). These members include, but are not limited to, steel joists, joist girders, purlins, columns, beams, trusses, splices,

seats, metal decking, girts, and all bridging cold-formed metal framing that is integrated with the structural steel framing of a building. (28-2.t)

u. Systems-Engineered Metal Building. A metal, field-assembled building system consisting of framing, roof, and exterior wall coverings. Typically, many of these components are cold-formed shapes. These individual parts are fabricated in one or more manufacturing facilities and shipped to the jobsite for assembly into the final structure. The engineering design of the system is normally the responsibility of the systems-engineered metal building manufacturer. (28-2.u)

28-3. Personnel Required Qualification/Training.

a. A QP must provide the training required by this chapter. (28-3.a)

b. The employer must ensure special training is provided for employees engaged in the following areas: (28-3.b)

(1) Multiple Lift Rigging (MLR). Train each employee who performs MLR on the nature and hazards associated with multiple lifts, and the proper procedures and equipment to perform multiple lifts (see chapter 15).

(2) Connecting. Train each employee who performs connections on the nature and hazards associated with connecting, and the establishment, access, proper connecting techniques, and work practices required by this chapter and 29 CFR 1926 Subpart R.

(3) Falls. Train each employee exposed to fall hazards training according to chapter 21.

(4) Controlled Decking Zone (CDZ). Train each employee working in CDZs on the nature and hazards associated with CDZs, and the establishment, access, proper installation and work practices required by this chapter and 29 CFR 1926 Subpart R.

28-4. Roles and Responsibilities.

a. The Controlling Contractor must. (28-4.a)

(1) Develop sequence of erection activities according to paragraph 28-7.a.

(2) Provide written notifications according to paragraphs 28-8.b and 28-8.m.

(3) Ensure adequate site layout according to paragraph 28-8.g.

(4) Coordinate other construction processes according to paragraph 28-8.x.

b. Competent Persons (CP) must: (28-4.b)

(1) Evaluate bracing equipment according to paragraph 28-8.j.

(2) Evaluate the need for guying or bracing on columns according to paragraph 28-8.m.

(3) Determine bolting requirements according to paragraph 28-8.n.

c. Qualified Persons (QP) must: (28-4.c)

(1) Provide all training required by this chapter and according to paragraph 28-3.

(2) Prepare steel erection plans according to paragraph 28-7.

(3) Direct the use of shim packs according to paragraph 28-8.m.

(4) Design alternate means of stabilizing joists according to paragraph 28-8.s.

(5) Approve the use of joists, girders, purlins, or girts for fall arrest anchorage according to paragraphs 28-8.s and 28-8.x.

d. Structural Engineer of record must: (28-4.d)

(1) Approve all repairs, replacements, or modifications to anchor rods or bolts according to paragraph 28-8.m.

(2) Specify bolt tightness according to paragraphs 28-8.n and 28-8.o.

(3) Approve all modifications to joists and girders according to paragraph 28-8.s.

28-5. Inspection Requirements.

Not Applicable.

28-6. Activity Hazard Analysis (AHA) Requirements.

Develop AHAs according to paragraphs 1-6 or 2-6, as applicable.

28-7. Minimum Plan Requirements.

Prior to beginning the erection of any structural steel, submit a Steel Erection Plan to the USACE supervisor for approval or to the KO or COR for acceptance. The plan must be signed and dated by the QP responsible for its preparation and modification. This plan must include the following:

a. Detailed description of the activity being performed to include: (28-7.a)

(1) Steel erection activities and procedures such as column, beam, joist, and purlin erection, erection of bridging terminus points, connections, decking, ornamental and miscellaneous iron.

(2) The sequence of erection activities developed in coordination with the controlling contractor.

(3) Stability considerations requiring temporary bracing and guying.

(4) Procedures for providing written notifications for anchor points according to paragraph 28-8.b.

(5) Procedures for coordination with other trades and construction activities.

(6) Material delivery procedures.

(7) Identification of staging, and storage areas.

(8) Procedures for developing a SLP according to chapter 16.

(9) Identification of any lifts classified as critical lifts, requiring separate plans (see chapter 16).

b. Description of the anticipated hazards or concerns and the control measures that will be implemented to control to an acceptable level to include: (28-7.b)

(1) An AHA (see paras 1-6 or 2-6, as applicable).

(2) A fall protection plan (see chapter 21).

c. Assignment of personnel and their roles and responsibilities. Include necessary information/documentation to support qualification/training of the following as required. (28-7.c)

(1) CP and QP.

(2) Documentation for each employee who has received training for performing steel erection operations, according to this chapter and 29 CFR 1926.761 (29 CFR 1926 Subpart R).

d. Inspection and oversight methods to ensure adherence to the plan. (28-7.d)

e. A description of the procedures that will be utilized in the event of rescue or emergency response. (28-7.e)

28-8. General Requirements.

a. Steel erection activities include but are not limited to, hoisting, laying out, placing, connecting, welding, burning, guying, bracing, bolting, plumbing, and rigging structural steel, steel joists and metal buildings; installing metal decking, miscellaneous metals, ornamental iron, and similar materials; and moving point-to-point while performing these activities (see 29 CFR 1926.750 (29 CFR 1926 Subpart R)). (28-8.a)

b. Written Notifications. Before authorizing the commencement of steel erection, the controlling contractor must ensure that the steel erector is provided with the following written notifications: (28-8.b)

(1) The concrete in the footings, piers, and walls has attained, on the basis of an appropriate ASTM standard test method of field-cured samples, either 75% of the intended minimum compressive design strength or sufficient strength to support the loads imposed during steel erection.

(2) Any repairs, replacements, and modifications to the anchor bolts were conducted according to with contract specifications or project structural engineer of record.

Note. Both steel and concrete contractors must keep a copy of this written notification onsite.

c. The fall protection threshold height requirement is 6 feet (1.8 m) for all work covered by this manual, whether performed by Government or contractor work forces, unless specified differently below. This includes steel erection activities and systems-engineered activities (that is, prefabricated metal buildings). (See chapter 21) (28-8.c)

d. Do not place construction loads on a structure or portion of a structure unless the employer determines, based on information from a person who is qualified in structural design, that the structure or portion of the structure can support the loads. (28-8.d)

e. Do not permit employees to work above or in positions exposed to protruding reinforcing steel, fasteners, or other impalement hazards unless provisions have been made to control the hazard. (28-8.e)

f. Do not permit employees to work under bundled material loads or other suspended loads. Riggers securing lower loads to multi-lift rigging assemblies and workers setting suspended structural components such as beams, trusses, and precast members are excluded from this requirement. In these cases, work controls must be used to minimize the time spent directly under loads. (28-8.f)

g. Site layout. The controlling contractor must ensure that the following is provided and maintained: (28-8.g)

(1) Adequate access roads into and through the site for the safe delivery and movement of derricks, cranes, trucks, other necessary equipment, and the material to be erected; and means and methods for pedestrian and vehicular control.

Note. This requirement does not apply to roads outside of the construction site.

(2) An adequately compacted, properly graded, drained area readily accessible to the work with adequate space for the safe storage of materials and the safe operation of the erector's equipment.

(3) Pre-planning of overhead hoisting operations. Pre-plan all steel erection hoisting operations.

h. Walking-working surfaces, shear connectors, and other similar devices. (28-8.h)

(1) Tripping hazards. Do not attach shear connectors (for example, headed steel studs, steel bars, steel lugs), reinforcing bars, deformed anchors, or threaded studs to the top flanges of beams, joists, or beam attachments so that they project vertically from or horizontally across the top flange of the member until after the metal decking, or other walking-working surface has been installed.

(2) When shear connectors are used in construction of composite floors, roofs, and bridge decks, lay out and install the shear connectors after the metal decking has been installed, using the metal decking as a working platform.

i. Structural steel assembly. (28-8.i)

(1) Maintain structural stability always during the erection process.

(2) The following additional requirements apply to multi-story structures:

(a) Install the permanent floors as the erection of structural members progresses. There must not be more than eight stories between the erection floor and the uppermost permanent floor, except where the structural integrity is maintained as a result of the design.

(b) At no time will there be more than four floors or 48 feet (14.6 m), whichever is less, of unfinished bolting or welding above the foundation or uppermost permanently secured floor, except where the structural integrity is maintained because of the design.

j. Install bracing equipment, as required, before the structure is loaded with construction material (for example, loads of joists, bundles of decking, or bundles of bridging). (28-8.j)

(1) When deemed necessary by a CP, install temporary erection bracing equipment in conjunction with the steel erection process to ensure the stability of the structure.

(2) Do not remove bracing equipment until approved by a CP.

k. Metal Decking. Hoist, land, and place metal decking bundles. (28-8.k)

(1) Lay tightly and secure metal decking upon placement to prevent accidental movement or displacement. Do not lay more than 3,000 ft² (278.7 m²) before securing.

(2) During initial installation, place metal-decking panels so that they are fully supported by structural members.

(3) Do not use bundle packaging and strapping for hoisting unless specifically designed for that purpose.

(4) If loose items such as dunnage, flashing, or other materials are placed on the top of metal decking bundles to be hoisted, secure such items to the bundles.

(5) Land the bundles of metal decking on joists according to paragraph 28-8.w.

(6) Land metal decking bundles on framing members so that enough support is provided to allow the bundles to be un-banded without dislodging the bundles from the supports.

(7) At the end of the shift or when environmental or jobsite conditions require, secure metal decking against displacement.

(8) Roof and floor holes and openings. Install metal decking at roof and floor holes and openings as follows:

(a) Framed metal deck openings must have structural members turned down to allow continuous deck installation except where not allowed by structural design constraints or constructability.

(b) Deck over or protect roof and floor holes and openings according to chapter 24.

(c) Do not cut metal decking holes or openings until immediately prior to being permanently filled with the equipment or structure needed or intended to fulfill its specific use and that meets the design drawings and/or manufacturers requirements or immediately cover or guard the hole or opening according to chapter 24.

I. Derrick Floors. (28-8.l)

(1) Fully deck and/or plank all derrick floors and complete the steel member connections to support the intended floor loading.

(2) Distribute temporary loads placed on derrick floors over the underlying support members to prevent local overloading of the deck material.

m. Column Anchorage. (28-8.m)

(1) General requirements for erection stability.

(a) Anchor all columns using a minimum of four anchor rods or anchor bolts.

(b) Design each column anchor rod or anchor bolt assembly, including the column-to-base plate weld and the column foundation, to resist a minimum eccentric gravity load of 300 lbs. (136.2 kg) located 18 inches (45.7 cm) from the extreme outer face of the column in each direction at the top of the column shaft.

(c) Set columns on level finished floors, pre-grouted leveling plates, leveling nuts, or shim packs. If shim packs are used, a QP must direct their use.

(d) A CP must evaluate all columns to determine whether guying or bracing is needed. Install all required guying or bracing.

(2) Repair, replacement, or field modification of anchor rods or anchor bolts.

(a) Do not repair, replace or field-modify anchor rods or anchor bolts without the approval of the project structural engineer of record.

(b) Prior to the erection of a column, the controlling contractor must provide written notification to the steel erector if there has been any repair, replacement, or modification of the anchor rods or anchor bolts of that column.

n. Beams and columns. (28-8.n)

(1) Do not release the load from the hoisting line during the final placing of solid web structural members until the members are secured with at least two bolts per connection of the same size and strength as shown in the erection drawings. Tighten the bolts to snug tight and/or as specified by the project structural engineer of record.

(2) A CP must determine those pieces that require more than two bolts in each end before the piece is released from the crane. Completely bolt column erection splices prior to adding more than two floors.

o. Diagonal Bracing. Secure solid web structural members used as diagonal bracing by at least one bolt per connection drawn up snug tight and/or the equivalent as specified by the project structural engineer of record. (28-8.o)

p. Double Connections. (28-8.p)

(1) Double connections at columns or at beam webs over a column. This requirement applies when two structural members on opposite sides of a column web, or a beam web over a column, are connected sharing common connection holes. At least one bolt with its snug tight nut must remain connected to the first member unless a shop-attached or field-attached seat or equivalent connection device is supplied with the member to secure the first member and prevent the column from being displaced. (See figures 28-3 and 28-4)

(2) If a seat or equivalent device is used, design the seat or device to support the load during the double connection process. Adequately bolt or weld the seat or device to both a supporting member and the first member before the nuts on the shared bolts are removed to make the double connection.

q. Column splices. Design each column splice to resist a minimum eccentric gravity load of 300 lbs. (136.2 kg) located 18 inches (45.7 cm) from the extreme outer face of the column in each direction at the top of the column shaft. (28-8.q)

r. Perimeter columns. Do not erect perimeter columns unless: (28-8.r)

(1) The perimeter columns extend a minimum of 48 inches (121.9 cm) above the finished floor to permit installation of perimeter safety cables prior to erection of the next tier, except where constructability does not allow.

(2) The perimeter columns have holes or other devices in or attached to perimeter columns at 42-45 inches (106.7-114.3 cm) above the finished floor, and at the midpoint between the finished floor and the top cable, to permit installation of perimeter safety cables, except where constructability does not allow.

s. Open web steel joists. (28-8.s)

(1) Except as provided in paragraph 28-8.s(2) below, where steel joists are used and columns are not framed in at least two directions with solid web structural steel members, field bolt a steel joist at the column to provide lateral stability to the column during erection. For the installation of this joist:

(a) Provide a vertical stabilizer plate on each column for steel joists. The plate must be a minimum of 6 inches x 6 inches (15.2 cm x 15.2 cm), it must extend at least 3 inches (7.6 cm) below the bottom chord of the joist and have a thirteen-sixteenth (13/16) inch (2.1 cm) hole to provide an attachment point for guying or plumbing cables.

(b) Stabilize the bottom chords of steel joists at columns to prevent rotation during erection.

(c) Do not release hoisting cables until the seat at each end of the steel joist is field-bolted, and each end of the bottom chord is restrained by the column stabilizer plate.

(2) Where constructability does not allow a steel joist to be installed at the column:

(a) Install an alternate means of stabilizing joists on both sides near the column to provide stability equivalent to paragraph 28-8.s(1). The alternate means must be designed by a QP, be shop installed, and included in the erection drawings.

(b) Do not release hoisting cables until the seat at each end of the steel joist is field-bolted and the joist is stabilized.

(3) Where steel joists at or near columns that span 60 feet (18.3 m) or less, design and erect the joist by either:

(a) Installing bridging or otherwise stabilizing the joist prior to releasing the hoisting cable.

(b) Releasing the cable without having a worker on the joist.

(4) Where steel joists at or near columns span more than 60 feet (18.3 m), set the joists in tandem with all bridging installed, unless a QP designs an alternative method of erection with equivalent stability to the steel joist, and includes it in the site-specific Steel Erection Plan.

(5) Do not place a steel joist or steel joist girder on any support structure unless such structure is stabilized.

(6) When steel joist(s) are landed on a structure, secure them to prevent unintentional displacement prior to installation.

(7) Do not make any modification that affects the strength of a steel joist or steel joist girder without the approval of the project structural engineer of record.

(8) Field-Bolted Joists.

(a) Except for steel joists that have been pre-assembled into panels, fabricate connections of individual steel joists to steel structures in bays of 40 feet (12.2 m) or more to allow for field bolting during erection.

(b) Field-bolt these connections unless constructability does not allow.

(9) Do not use steel joists or steel joist girders as anchorage points for a personal fall arrest system unless a QP provides written approval.

(10) Establish a bridging terminus point before bridging is installed.

t. Attachment of steel joists and steel joist girders. (28-8.t)

(1) Attach each end of "K" series steel joists to the support structure with a minimum of two 1/8 inch (0.3 cm) fillet welds that are 2½ inches (6.35 cm) long, or with two one-half (½) inch (1.3 cm) bolts, or the equivalent.

(2) Attach each end of "LH" and "DLH" series steel joists and steel joist girders to the support structure with a minimum of two one-quarter (¼) inch (0.6 cm) fillet welds 2 inches (5.1 cm) long, or with two three-quarter (¾) inch (1.9 cm) bolts, or the equivalent.

(3) Except as provided in (4) below, attach each steel joist to the support structure immediately upon placement in the final erection position and before placing additional joists.

(4) Attach panels that have been pre-assembled from steel joists with bridging to the structure at each corner before releasing the hoisting cables.

u. Erection of steel joists. (28-8.u)

(1) Attach both sides of the seat of one end of each steel joist that requires bridging to the support structure before releasing the hoisting cables. See tables 28-1 and 28-2 for bridging requirements.

(2) For joists over 60 feet (18.3 m), attach both ends of the joist as specified in paragraph 24-8.t and incorporate the provisions of paragraph 28-8.v before releasing the hoisting cables.

(3) On steel joists that do not require erection bridging as specified in tables 28-1 and 28-2, allow only one employee on the joist until all bridging is installed and anchored.

(4) Do not allow employees on steel joists where the span of the steel joist is equal to or greater than the span shown in tables 28-1 and 28-2. Follow the requirements of paragraph 28-8 v.

(5) When permanent bridging terminus points cannot be used during erection, install additional temporary bridging terminus points to provide stability.

v. Erection bridging. (28-8.v)

(1) Where the span of the steel joist is equal to or greater than the span shown in tables 28-1 and 28-2, follow these requirements:

(a) Install a row of bolted diagonal erection bridging near the mid-span of the steel joist.

(b) Do not release hoisting cables until the required bolted diagonal erection bridging is installed and anchored, see table 28-1.

(c) Do not allow more than one employee on these spans until all other bridging is installed and anchored.

(2) Where the span of the steel joist is over 60 feet (18.3 m) and up to 100 feet (30.5 m), follow these requirements:

(a) All rows of bridging must be bolted diagonal bridging.

(b) Install two rows of bolted diagonal erection bridging near the third points of the steel joist.

(c) Do not release hoisting cables until this bolted diagonal erection bridging is installed and anchored.

(d) Do not allow more than two employees on these spans until all other bridging is installed and anchored.

(3) Where the span of the steel joist is over 100 feet (30.5 m) and up to 144 feet (43.9 m), follow these requirements:

(a) All rows of bridging must be bolted diagonal bridging.

(b) Do not release hoisting cables until all bridging is installed and anchored.

(c) Do not allow more than two employees on these spans until all bridging is installed and anchored.

(4) For steel members spanning over 144 feet (43.9 m), the erection methods used must follow paragraphs 28-8.n. through q.

(5) Where any steel joist specified in paragraph 28-8.v(2) above or paragraphs 28-8.w(1) through (3) is a bottom chord-bearing joist, provide a row of bolted diagonal bridging near the supports. Install this bridging and anchor it before releasing the hoisting cables.

(6) When bolted diagonal erection bridging is required by paragraph 28-8.v follow these requirements:

- (a) Indicate the bridging on the erection drawing.
- (b) Use the erection drawings as the exclusive indicator of the proper placement of this bridging.
- (c) Use shop-installed bridging clips or functional equivalents where the bridging bolts to the steel joists (see figures 28-1, 28-2 and 28-5).
- (d) When two pieces of bridging are attached to the steel joist by a common bolt, do not remove the nut that secures the first piece of bridging from the bolt when attaching the second piece of bridging.
- (e) Do not allow bridging attachments to protrude above the top chord of the steel joist.

w. Landing and Placing Loads. (28-8.w)

(1) During the construction period, the employer must ensure that when placing a load on steel joists the load is distributed so it does not exceed the carrying capacity of any steel joist.

(2) Except as stated in paragraph 28-8.w(4) below, do not place construction loads on the steel joists until all bridging is installed and anchored and all joist-bearing ends are attached.

(3) The weight of a bundle of joist bridging may not exceed a total of 1,000 lbs. (454 kg). Place each bundle of joist bridging on a minimum of three steel joists that are secured at one end. Position the edge of the bridging bundle within 1 foot (0.3 m) of the secured end.

(4) Do not place any bundles of decking on steel joists until all bridging has been installed and anchored and all joist bearing ends attached, unless all of the following conditions are met:

- (a) A QP has documented in a site-specific Steel Erection Plan that the structure or portion of the structure can support the load.
- (b) The bundle of decking is placed on a minimum of three steel joists.
- (c) The joists supporting the bundle of decking are attached at both ends.
- (d) At least one row of bridging is installed and anchored.

(e) The total weight of the bundle of decking does not exceed 4,000 lbs. (1814.4 kg), and the edge of the construction load is placed within 1 foot (0.3 m) of the bearing surface of the joist end.

x. Systems-Engineered Metal Buildings. (28-8.x)

(1) All of the requirements of this chapter apply to the erection of systems-engineered metal buildings except paragraph 28-8.m (column anchorage) and paragraph 28-8.s (open web steel joists).

(a) Anchor each structural column using a minimum of four anchor rods or anchor bolts.

(b) Rigid frames must have 50% of their bolts or the number of bolts specified by the manufacturer, whichever is greater, installed and tightened on both sides of the web adjacent to each flange, before the hoisting equipment is released.

(c) Do not place construction loads on any structural steel framework unless such framework is safely bolted, welded, or otherwise adequately secured.

(d) In girt and eave strut-to-frame connections, where girts or eave struts share common connection holes, at least one bolt with its snug tight nut must remain connected to the first member. The exception to this is when a manufacturer-supplied, field-attached seat or similar connection device is present to secure the first member so that the girt or eave strut is always secured against displacement.

(e) Do not use purlins and girts as an anchorage point for a PFAS unless a QP for Fall Protection provides written approval to do so.

(f) Do not use purlins as a walking or working surface when installing safety systems until all permanent bridging has been installed and fall protection is provided.

(g) Only place construction loads within a zone that is within 8 feet (2.4 m) of the centerline of the primary support member.

(h) Fully bolt or weld both ends of all steel joists or cold-formed joists to the support structure before releasing the hoisting cables, allowing an employee on the joist, or allowing any construction loads on the joists.

(2) Falling object protection.

(a) Securing loose items aloft. Secure all materials, equipment, and tools that are not in use while aloft against accidental displacement.

(b) Provide protection from falling objects other than materials being hoisted. The controlling contractor must not allow other construction processes below steel erection unless overhead protection for the employees below is provided.

(3) CDZ are not permitted.

28-9. Figures and Tables.

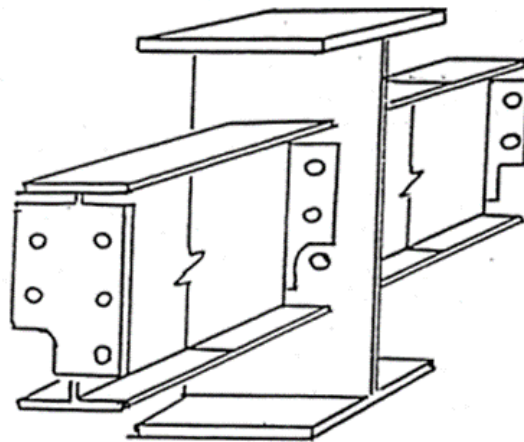

Figure 28-1. Clip End Connection

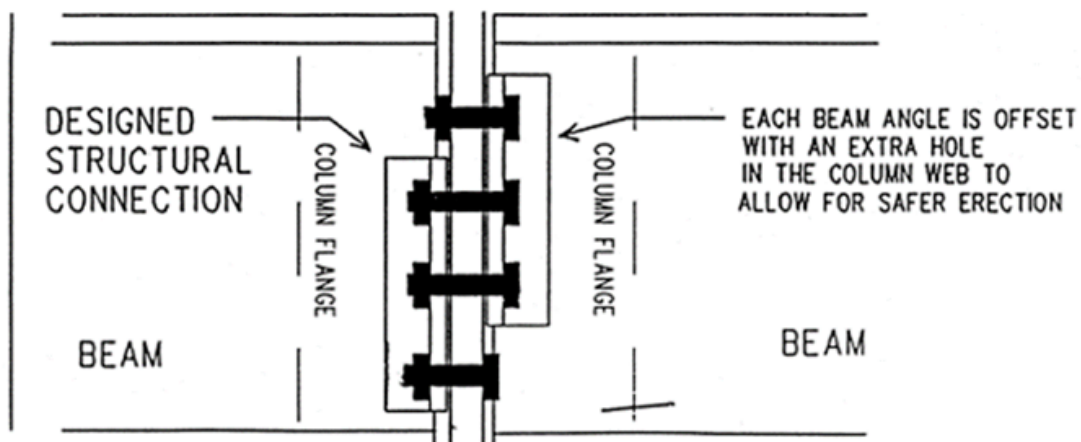

Figure 28-2. Staggered (High/Low Connection)

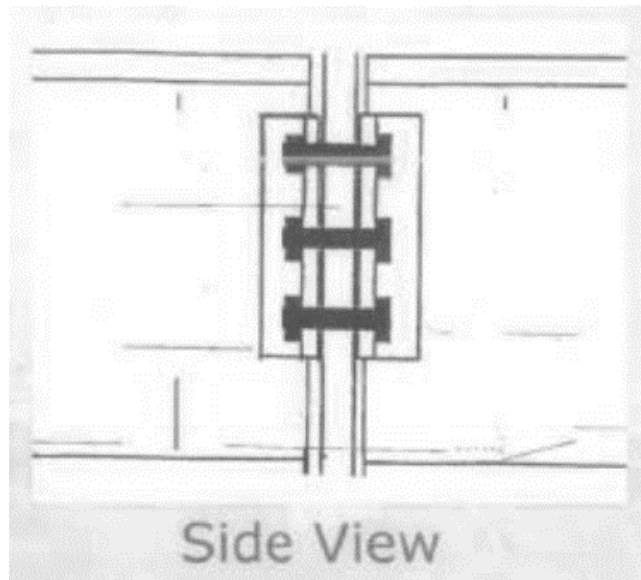

Figure 28-3. Controlling Risk for Double Connections in Steel Erection (Side View).

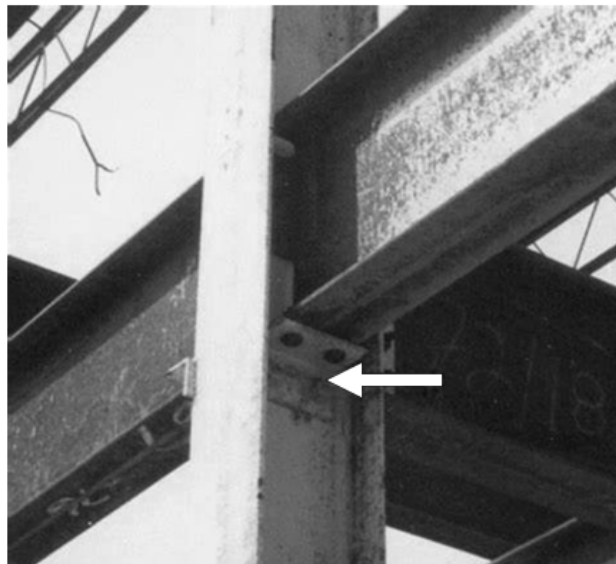

Figure 28-4. Double Connection with Seat to Support First Section While Second Section is Being Installed

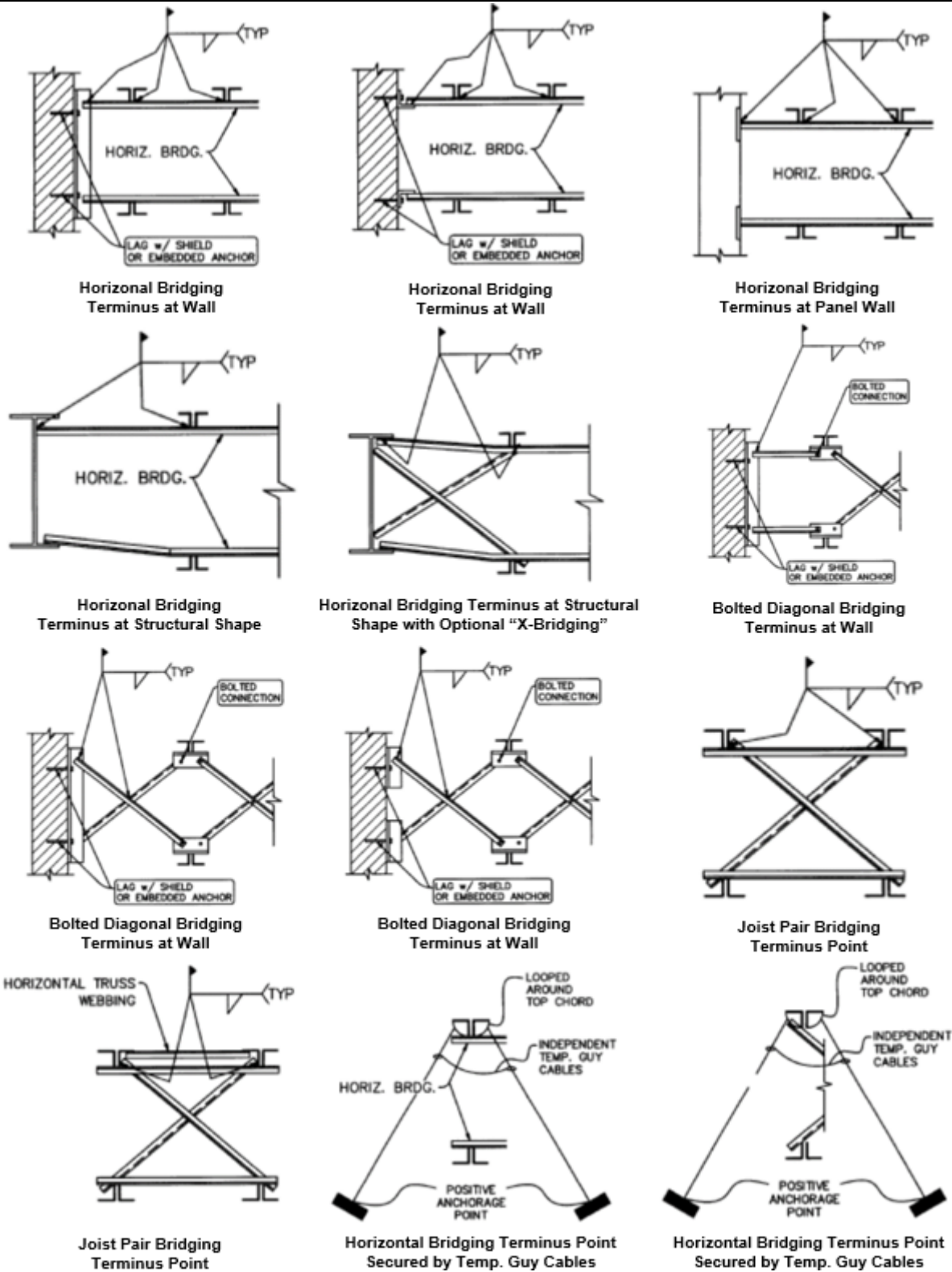

Figure 28-5. Illustrations of OSHA Bridging Terminus Points

**Table 28-1
Erection Bridging for Short Span Joists**

JOIST	SPAN	JOIST	SPAN	JOIST	SPAN	JOIST	SPAN
8K1	NM	16KCS3	NM	22K11	NM	26K7	43-0
10K1	NM	16KCS4	NM	22K4	34-0	26K8	44-0
10KCS1	NM	16KCS5	NM	22K5	28-0	26K9	44-0
10KCS2	NM	18K10	NM	22K6	36-0	26KCS2	39-0
10KCS3	NM	18K3	31-0	22K7	40-0	26KCS3	44-0
12K1	23-0	18K4	32-0	22K9	40-0	26KCS4	NM
12K3	NM	18K5	33-0	22KCS2	36-0	26KCS5	NM
12K5	NM	18K6	28-0	22KCS3	40-0	28K10	49-0
12KCS1	NM	18K7	NM	22KCS4	NM	28K12	53-0
12KCS2	NM	18K9	NM	22KCS5	NM	28K6	40-0
12KCS3	NM	18KCS2	28-0	24K10	NM	28K7	43-0
14K1	27-0	18KCS3	NM	24K12	NM	28K8	44-0
14K3	NM	18KCS4	NM	24K4	36-0	28K9	45-0
14K4	NM	18KCS5	NM	24K5	38-0	28KCS2	40-0
14K6	NM	20K10	NM	24K6	39-0	28KCS3	45-0
14KCS1	NM	20K3	32-0	24K7	43-0	28KCS4	53-0
14KCS2	NM	20K4	34-0	24K8	43-0	28KCS5	53-0
14KCS3	NM	20K5	34-0	24K9	44-0	30K10	50-0
16K2	29-0	20K6	36-0	24KCS2	39-0	30K11	52-0
16K3	30-0	20K7	39-0	24KCS3	44-0	30K12	54-0
16K4	32-0	20K9	39-0	24KCS4	NM	30K7	44-0
16K5	32-0	20KCS2	36-0	24KCS5	NM	30K8	45-0
16K6	NM	20KCS3	39-0	26K10	49-0	30K9	45-0
16K7	NM	20KCS4	NM	26K12	NM	30KCS3	45-0
16K9	NM	20KCS5	NM	26K5	38-0	30KCS4	54-0
16KCS2	NM	22K10	NM	26K6	39-0	30KCS5	54-0

NM = diagonal bolted bridging not mandatory.

**Table 28-2
Erection Bridging for Long Span Joists**

JOIST	SPAN	JOIST	SPAN
18LH02	33-0	28LH05	42-0
18LH03	NM	28LH06	46-0
18LH04	NM	28LH07	54-0
18LH05	NM	28LH08	54-0
18LH06	NM	28LH09	NM
18LH07	NM	28LH10	NM
18LH08	NM	28LH11	NM
18LH09	NM	28LH12	NM
20LH02	33-0	28LH13	NM
20LH03	38-0	32LH06	47-0 THROUGH 60-0
20LH04	NM	32LH07	47-0 THROUGH 60-0
20LH05	NM	32LH08	55-0 THROUGH 60-0
20LH06	NM	32LH09	NM THROUGH 60-0
20LH07	NM	32LH10	NM THROUGH 60-0
20LH08	NM	32LH11	NM THROUGH 60-0
20LH09	NM	32LH12	NM THROUGH 60-0
20LH10	NM	32LH13	NM THROUGH 60-0
24LH03	28-0	32LH14	NM THROUGH 60-0
24LH04	39-0	32LH15	NM THROUGH 60-0
24LH05	40-0	36LH07	47-0 THROUGH 60-0
24LH06	45-0	36LH08	47-0 THROUGH 60-0
24LH07	NM	36LH09	57-0 THROUGH 60-0
24LH08	NM	36LH10	NM THROUGH 60-0
24LH09	NM	36LH11	NM THROUGH 60-0
24LH10	NM	36LH12	NM THROUGH 60-0
24LH11	NM	36LH13	NM THROUGH 60-0
		36LH14	NM THROUGH 60-0
		36LH15	NM THROUGH 60-0

NM = Diagonal bolted bridging not mandatory for joists.

28-10. Checklists and Forms.

Not Applicable.

Chapter 29

Blasting

This chapter applies to blasting activities performed by DoD civilians or by contractors under direction of USACE for work involving commercial explosives on Civil and Military construction projects.

29-1. References.

- a. Alcohol Tobacco and Firearms (ATF) P 5400.7, Publication of Federal Explosives Laws and Regulations
(<https://www.atf.gov/explosives/docs/report/publication-federal-explosives-laws-and-regulations-atf-p-54007>) (29-1.a)
- b. ANSI/ASSP A10.7, Safety and Health Requirements for Construction and Demolition Use, Storage, Handling and Site Movement of Commercial Explosives and Blasting Agents (<https://webstore.ansi.org/>) (29-1.b)
- c. DA Pam 385-64, Ammunition and Explosives Safety Standards (<https://armypubs.army.mil/ProductMaps/PubForm/PAM.aspx>) (29-1.c)
- d. Defense Explosives Safety Regulation 6055.09 (<https://denix.osd.mil/>) (29-1.d)
- e. Institute of Makers of Explosives (IME) SLP-14, Handbook for the Transportation and Distribution of Explosive Materials
(https://www.ime.org/products/category/safety_library_publications_slps) (29-1.e)
- f. IME SLP-3, Suggested Code of Regulations for the Manufacture, Transportation, Storage, Sale, Possession and Use of Explosive Materials
(https://www.ime.org/products/category/safety_library_publications_slps) (29-1.f)
- g. IME SLP-20, Safety Guide for the Prevention of Radio Frequency Radiation Hazards in the Use of Commercial Electric Detonators (Blasting Caps)
(https://www.ime.org/products/category/safety_library_publications_slps) (29-1.g)
- h. NFPA 495, Explosive Materials Code
(<https://www.nfpa.org/Codes-and-Standards>) (29-1.h)
- i. UFGS 31 23 00.00, Tunnel Excavation – Blasting
(<https://www.wbdg.org/ffc/dod/unified-facilities-guide-specifications-ufgs/ufgs-31-23-00-00>) (29-1.i)

j. 27 CFR 555, Commerce in Explosives (<https://www.govinfo.gov/content/pkg/CFR-2020-title27-vol3/pdf/CFR-2020-title27-vol3-part555.pdf>) (29-1.j)

k. 29 CFR 1910.109, Explosives and Blasting Agents (<https://www.govinfo.gov/content/pkg/CFR-2020-title29-vol5/pdf/CFR-2020-title29-vol5-sec1910-109.pdf>) (29-1.k)

l. 29 CFR 1926 Subpart U, Blasting and the Use of Explosives (<https://www.govinfo.gov/content/pkg/CFR-2020-title29-vol8/pdf/CFR-2020-title29-vol8-part1926-subpartU.pdf>) (29-1.l)

m. 49 CFR 177.835, Class 1 Materials (<https://www.govinfo.gov/content/pkg/CFR-2020-title49-vol2/pdf/CFR-2020-title49-vol2-sec177-835.pdf>) (29-1.m)

29-2. Definitions.

a. Attendant. An authorized individual who has the explosives or the use of explosives within their field of vision and with the ability to respond appropriately. (29-2.a)

b. Blast Area. The area of a blast within the influence of flying rock and ejecta, gases, and concussion that may cause injury to persons or property. (29-2.b)

c. Blast Site. The area where explosive material is handled during the loading of blastholes, including 50 feet (15.2m) in all directions from the perimeter formed by loaded holes. A minimum of 30 feet (9.1 m) may replace the 50 feet (15.2m) requirement if the perimeter of loaded holes is marked and separated from non-blast site areas by a barrier. The 50 feet (15.2 m) or 30 feet (9.1 m) distance requirements, as applicable, apply in all directions along the full depth of the blasthole. In underground mines, at least 15 feet (4.6 m) of a solid rib, pillar, or broken rock can be substituted for the 50 feet (15.2 m) distance. (29-2.c)

d. Blaster. A qualified individual who assists with the design, loading, and firing of explosives. (29-2.d)

e. Blaster-in-Charge. The blaster who is in charge of and responsible for the design, loading, and firing of explosives at a specific jobsite. (29-2.e)

f. Bootlegs. The part of a drilled blasthole that remains when the force of the explosion does not break the rock completely to the bottom of the hole. (29-2.f)

g. Electric Detonator. A detonator designed for, and capable of, initiation by means of an electric current. (29-2.g)

h. Electronic Detonator. A detonator that utilizes stored electrical energy as a means of powering an electronic timing delay element/module and that provides initiation energy for firing the base charge. (29-2.h)

i. Flyrock. Material propelled from the blast area by the force of an explosion. (29-2.i)

j. Qualified Person (QP). See paragraphs 1-2 or 2-2, as applicable. (29-2.j)

k. Underground Blasting. The controlled use of explosives and other methods in underground construction, shafts, and caissons. (29-2.k)

29-3. Personnel Required Qualification/Training.

a. General. (29-3.a)

(1) The personnel that are involved in blasting operations must be trained in the following:

(a) The requirements for handling, transportation, and storage of explosives.

(b) Employee training programs and certifications as required by state or company.

(c) Types of explosives.

(d) Schedule of activities and loading procedures.

(e) Detailed blasting schedule.

(f) Explosives transportation route.

(g) Safety signals, methods, and locations.

(h) Blast area clearance.

(i) Methods for securing the site.

(2) All personnel working with explosives must be in good physical condition to perform the necessary tasks. Personnel must be able to understand and give written and verbal orders.

(3) All persons involved in the transportation, storage, handling, or use of explosives or blasting agents must be at least 21 years old. If allowed by applicable national, state, or local regulations, workers at least 18 years old only handling explosive materials must be supervised by a licensed blaster.

(4) All persons involved in the transportation, storage, handling, or use of explosives or blasting agents must be trained and able to read and understand instructions in English.

(5) All individuals handling explosive materials must be trained in the following areas:

(a) The physical and health hazards of the explosive materials.

(b) The operational activities involved in use of the explosives.

(c) Plans for emergency procedures in case of a fire or explosion.

b. Transporting Explosive Materials. (29-3.b)

(1) Operators of vehicles transporting explosive materials must be physically fit, careful, reliable, able to read and understand safety instructions (see para 18-3).

(2) Only the authorized driver and helper are permitted to ride on any conveyance transporting explosive materials or detonators.

(3) The driver must be trained in the use of a portable extinguisher (see chapter 9).

(4) Drivers must be trained in the DOT or DoD applicable standards.

c. Blasters. Blasters must be trained and certified for the type of blasting performed onsite. (29-3.c)

(1) Blasters must be qualified, by reason of training, knowledge, or experience, in the field of transporting, storing, handling, and use of explosives. They must have a working knowledge of state and local laws and regulations which pertain to explosives.

(2) Blasters must be licensed, as applicable, according to state and local regulations.

(3) Blasters must furnish satisfactory evidence of competency in handling explosives and performing in a safe manner the type of blasting that will be required.

(4) Blasters must be knowledgeable about the use of each type of explosive material and blasting circuit that is being employed.

d. Blaster-in-Charge. The Blaster-in-Charge must be licensed by the AHJ. When working in a jurisdiction without an applicable licensing program managed by the AHJ, the Blaster-in-Charge must be a CP. See paragraphs 1-2 or 2-2, as applicable, for the definition of a CP. (29-3.d)

e. Attendants. Attendants must be: (29-3.e)

(1) Aware of the class of explosive material in the motor vehicle and of its inherent dangers.

(2) Familiar with the measures and procedures to be followed to protect the public from inherent dangers.

(3) Familiar with the vehicle they are assigned to attend.

(4) Trained, authorized, and enabled to move the vehicle when required.

(5) Awake and alert and not engaged in other duties or activities such as phone conversations, texting, listening to music, or engaged in other electronic or internet activities that divert the Attendant's attention from the vehicle and explosives.

29-4. Roles and Responsibilities.

a. Blaster. (29-4.a)

(1) For electric and electronic detonators, Blasters must test all blasting circuits using only blasting galvanometers or other instruments that have been specifically designed for this purpose.

(2) Keep an accurate, up-to-date record of explosives, blasting agents, and blasting supplies used in each blast.

b. Blaster-in-Charge. The Blaster-in-Charge is responsible for conducting the following: (29-4.b)

(1) Removing electric circuits.

(2) Ensuring safe illumination of the blast site.

(3) Loading shot holes.

(4) Connecting up blasting circuits.

(5) Vacating the blast site.

(6) Safe disposition of personnel during blasting.

(7) Detonating the round.

(8) Conduct a thorough inspection of the blast components after the blast connection hookup of the detonators according to the Master Blasting Plan.

(9) Ensure that proper shunting and/or connection practices are followed and that the blasting leads are not connected to the power source, blasting machine or other initiating device until the blast is ready to be fired.

(10) Inspecting the blast site post detonation to verify that all changes have detonated, determine it is safe, and give the all-clear signal.

(11) Develop a procedure for resolving the misfire and communicate that plan to essential personnel before work begins. The procedure will be detailed in the Master Blasting Plan.

(12) Oversee transportation, handling, storage, and use of explosives, blasting agents, and blasting equipment, to include supervising Blasters, directing and supervising all loading and firing, and supervising drilling performed to neutralize misfires. Ensure all personnel are physically fit and able to perform task as necessary.

c. Explosive Workers/Handlers. All persons involved in the transportation, storage, handling, or use of explosives or blasting agents must not be under the influence of intoxicants, narcotics, or other substances that reduce their ability to function normally. (29-4.c)

29-5. Inspection Requirements.

a. Blasting Machines. Inspect blasting machines according to the manufacturer's instructions. (29-5.a)

b. All loaded holes or charges must be checked and located, and all detonating cord connections must be inspected before firing the blast. (29-5.b)

c. Blaster. Inspect the blaster to determine that all charges have been exploded. An assessment of the blast site must include identification of components that may safely be inspected and a determination of the appropriate actions according to the Master Blasting Plan. (29-5.c)

d. Motor Vehicle. Motor vehicles used for transporting explosive materials must be inspected each day before use to determine that it is in proper condition for safe transportation. The inspection must verify that: (29-5.d)

(1) Fire extinguishers are charged and ready for use.

(2) All electric wiring is protected and fastened to prevent short-circuiting.

(3) Chassis, motor, pan, and underside of body are reasonably clean and free of excess oil and grease.

(4) Fuel tanks, feed lines, and crossover lines are secure and have no leaks.

(5) Brakes, lights (including back-up lights), alarms, horns, windshield wipers, defrosters, and steering apparatus are functioning properly.

(6) Tires are properly inflated and are in serviceable condition, and free of defects and mismatching, which might cause overheating or failure.

(7) Safety signs/placards are displayed.

e. Magazine Inventory. Inspect magazine inventories to verify contents and quantities including: (29-5.e)

(1) Date of acquisition.

(2) Name/Brand of manufacturer.

(3) Manufacturers marks/identification.

(4) Quantity.

(5) Description.

(6) Name, address, and license number of the deliverer.

(7) Daily transactions with documentation available upon request.

(8) That the magazine was inspected at least every seven days with documentation available upon request.

f. Magazines. Inspect magazines to verify: (29-5.f)

(1) Magazine and locks meet the requirements of ATF P 5400.7.

(2) All access roads to explosive material storage facilities are posted with a sign stating not to fight explosive fires, that explosives are stored onsite, and a contact number.

(3) All signs are located so that a bullet passing through the sign will not strike a magazine.

(4) Magazines are only used to store explosive materials and other blasting materials.

(5) That the total net explosive weight stored does not exceed the quantity for which the magazine is suited.

(6) The magazine is properly grounded.

(7) The local fire department has been notified of the type, magazine capacity, and location of each site where explosive materials are stored.

g. Blasting Records. Inspect blasting records to verify that they contain: (29-5.g)

(1) Names of the Blaster-in-Charge and individual crew members.

(2) Names of all personnel present at the blast site during loading.

(3) The exact blast site location and weather conditions.

(4) Individual blast-specific information to include loading of holes, geologic data such as changes of rock conditions observed in drilling bore holes, and vibration compliance data.

(5) A sketch of the blast site showing the locations and number of detonators and primers and pounds of explosive.

(6) Time of the blast.

(7) The Blaster-in-Charge's signature.

29-6. Activity Hazard Analysis (AHA) Requirements.

Develop AHAs according to paragraphs 1-6 or 2-6, as applicable. The AHA must provide provisions for the blasting activities performed to include transportation and handling.

29-7. Minimum Plan Requirements.

a. Explosives Site Safety Plan (ESSP). An ESSP is required when explosives are stored onsite. The plan must be developed according to ANSI/ASSP A10.7 and applicable federal and state and regulations prior to placing explosives onsite or starting explosives-related operations. If the site is a military installation, the ESSP must be approved by DoD Explosives Safety Board. (29-7.a)

b. Master Blasting Plan. Develop a Master Blasting Plan prior to the placement of explosives onsite or the start of any explosives related operations. Submit Master Blasting Plan to the USACE supervisor for approval by the blasting subject matter expert (SME), or to the KO or COR for acceptance by the blasting SME. As a minimum, it must contain the following: (29-7.b)

(1) The names, qualifications, certifications, and responsibilities of personnel involved with explosives, see paragraph 29-3. Include at a minimum the Blaster-in-Charge.

- (2) The contractor's requirements for handling, transporting, and storing explosives.
- (3) Employee training programs and certifications.
- (4) Types of explosives.
- (5) Schedule of activities and loading procedures.
- (6) Detailed blasting schedule.
- (7) Explosives transportation route.
- (8) Safety signals methods and locations.
- (9) Blast area clearance.
- (10) Example wiring diagram.
- (11) Methods for securing the site.
- (12) Seismograph, vibration, and damage control.
- (13) Test shots, post-blast inspection and misfire procedures.
- (14) Provisions for disposal of explosives, blasting agents, unused and associated material.
- (15) Post-blast ventilation requirements.
- (16) Public relations requirements before and after blasting (for example, community communication and protection of structures and personnel).
- (17) Misfire procedures.
- (18) The safe setback distance for personnel during blasting and misfire remediation. The distance must be based on the distance of physical separation and/or engineered or natural barriers.
- (19) Lightning and static hazard procedure for the project specifications will detail what is required for each on a project.

c. Vibration Monitoring Plan. Prepare a written plan for monitoring vibrations and air blast prior to initiation of controlled blasting operations for USACE supervisor for approval or KO or COR for acceptance. The plan, at a minimum, must include:

- (1) Structures requiring a pre-blast survey.
- (2) Locations for monitoring instrumentation.
- (3) Types and number of instruments.
- (4) Example reports for displaying monitoring results.

29-8. General Requirements.

a. General. (29-8.a)

(1) Prerequisites. Obtain written permission from the USACE supervisor/KO or COR before bringing explosive materials onto the jobsite. Periodic replenishment of previously approved supplies does not require re-approval.

(2) A Blaster-in-Charge must oversee the transporting, handling, storing, and use of explosives, blasting agents, and blasting equipment. Blasters must work under the supervision of the Blaster-in-Charge.

(3) Provide warning signs at points of access to blasting area.

(4) Discontinue operations involving the handling or use of explosive materials and move personnel to a safe area during the approach or progress of a thunderstorm or dust storm. Establish and implement controls to prevent accidental discharge of electric blasting caps from extraneous electricity.

(5) Do not perform blasting operations near overhead power lines, communications lines, utility services, or other structures until the operators and/or owners have been notified and measures for safe control have been taken.

(6) The Blaster-in-Charge will direct and supervise all loading and firing.

(7) Use a positive system to detect and measure the probability of lightning or massive static electrical discharges.

(8) Follow procedures in the Master Blasting Plan when lightning or static hazard is present or when a static detection device indicates a potential hazard.

(9) Use an electric blasting machine or a properly designed power source to initiate any blasts fired by electric detonators.

(a) Use a blasting machine or starting device according to the manufacturer's instructions to initiate any blasts fired by non-electric detonators.

(b) Use an approved non-electrical initiation system according to the manufacturer's instructions and system requirements when blasting near radar or radio transmission facilities or near electrical energy sources where testing has shown that RF energy or stray electrical current may present a hazard from electrical blasting.

(c) When electric detonators are used, short circuit (shunt) the leg wires until connected into the circuit for firing.

(10) Initiate detonating cord by non-electric detonator (cap and fuse), electric detonator, shock tube detonator or gas-initiated detonator according to the manufacturer's instructions.

(11) Use delayed electric detonators, non-electric delay detonators, detonating cord connectors, or electronic detonators for all delayed blasts according to the manufacturer's instructions.

(12) After firing the shot, immediately disconnect the cable between the switches and lock both switches in the open position.

(13) The Blaster must keep possession of the keys to the blaster at all times.

(14) Use appropriately sized insulated solid core wires in good condition for all lines.

(15) Provide sufficient firing line to permit the blaster to be located at a safe distance from the blast. Consider the following factors when determining the safe distance of the blast area:

(a) Geology or material to be blasted.

(b) Blast pattern.

(c) Burden, depth, diameter, and angle of the holes.

(d) Previous blasting experience at the site.

(e) Delay system, powder factor, and pounds per delay.

(f) Type and amount of explosive material.

(g) Type and amount of stemming.

(16) Do not operate mechanized equipment (including drills) within 50 feet (15.2 m) of a loaded hole, unless blasting mats or back covering are placed.

(17) The use of black powder is prohibited.

(18) All refuse from explosive loading, such as empty boxes, paper, and fiber packing, may not be reused for any purpose. Obliterate all explosive markings and dispose of the refuse at an approved location or make it unusable by a method approved by the USACE supervisor or accepted by the KO or COR.

b. Blasting Machines. (29-8.b)

(1) Operate, maintain, test (prior to use and periodically thereafter), and inspect blasting machines according to the manufacturer's instructions.

(2) Secure blasting machines so they are accessible only to the Blaster. Only the Blaster is permitted to connect the leading wire to the machine.

(3) Do not connect any firing line to a blasting machine or other power source until the shot is to be fired. The firing line must be checked with an approved blasting instrument before being connected to the blasting machine or other power source.

c. Blasting Power Supply. When energy for blasting is taken from power circuits, the voltage must not exceed 550 volts. (29-8.c)

(1) The blasting switch must be an ungrounded UL (or other NRTL) listed, enclosed, and externally operated double-pole double-throw switch that will shunt the firing lines when locked in the open position.

(2) Install a grounded switch between the blasting switch and the power circuit at a distance not less than 15 feet (4.6 m) from the blasting switch.

(3) Provide a lightning gap of at least 15 feet (4.6 m) between the two switches. Use cable, plug, and receptacle to make the gap connection.

d. Storage of Explosives. (29-8.d)

(1) When on a DoD installation, store explosives according to the requirements of the ESSP.

(2) When on a non-DoD installation, store explosives according to the requirements of ATF P 5400.7.

(3) Keep two copies of an accurate running inventory of all explosives and blasting agents stored at the project site. Keep one at the magazine and one in a facility which is at least 50 feet (15.2 m) from the magazine.

e. Security of Explosives. (29-8.e)

(1) Guard magazine areas to control access to the explosives and to ensure no one tampers with explosives during non-working hours.

(2) Do not abandon explosive materials.

(3) If explosives are lost or stolen, immediately (within 24 hours) report the circumstances and details of incident to the nearest ATF office, the local law enforcement authorities, and the USACE supervisor/KO or COR.

f. Transportation of Explosive Materials. (29-8.f)

(1) Comply with the following federal requirements and any applicable state requirements when transporting explosive materials by the following modes.

(a) Comply with the DOT requirements when transporting over public highways.

(b) Comply with the USCG requirements when transporting by vessel.

(c) Comply with the FAA requirements when transporting by aircraft.

(2) Do not load vehicles used for transportation of explosive materials beyond their rated capacity. Secure the explosive materials to prevent shifting of load or dislodgment from the vehicle. When explosive materials are transported by a vehicle with an open body, securely mount a magazine or closed container on the bed to contain the cargo.

(3) Display placards, lettering, and/or numbering required by DOT on all vehicles transporting explosive materials.

(4) Do not transport explosive materials and blasting supplies with other materials or cargoes. Do not transport detonators in the vehicle or conveyance with other explosives performed according to 49 CFR 177.835.

(5) Vehicles used in the transportation of explosives must be substantially constructed, in good repair, and must have tight beds to prevent explosives from falling from the vehicle. The ends and sides of vehicles must be high enough to prevent containers from falling off.

(6) Do not carry any spark-producing tools, carbides, oils, matches, firearms, electric storage batteries, flammable substances, acids, or oxidizing or corrosive compounds in the bed or body of any vehicle transporting explosive materials.

(7) Equip vehicles transporting explosive materials with two fire extinguishers having a rating of 4A-40B:C per NFPA 495 and IME SLP-3 and place them at strategic spots (see para 9-7).

(a) The extinguishers must be of a type listed by a NRTL and must be ready for use.

(b) Train the driver on how to use the fire extinguisher (see para 29-3.b).

(8) Do not drive a vehicle containing explosive materials into a garage or repair shop, park it in congested areas, or store it for any time in a public garage or similar building.

(9) Operate vehicles transporting explosive materials with extreme care. Drivers must stop at approaches to all railroad crossings and main highways, and the vehicles may not proceed until it is known that the way is clear.

(10) Refuel vehicles loaded with explosives according to DA Pam 385-64.

(11) Persons employed in the transportation, handling, or other use of explosive materials must not smoke or carry on their persons or in the vehicle any matches, firearms, ammunition, or flame-producing devices.

(12) Make provision for safe transfer of explosive materials to magazine vessels (for example, substantial ramps or walkways free of tripping hazards).

(13) Do not leave vehicles transporting explosive materials unattended.

(14) Notify the hoist operator before explosive materials are transported in a shaft conveyance.

(15) For underground work, hoist, lower, or convey explosive materials in a powder car. Do not transport any other materials, supplies, or equipment in the same conveyance at the same time.

(16) Do not permit any persons to ride in any shaft conveyance transporting explosive materials. Load and unload only when the conveyance is stationary.

(17) Do not transport explosive materials on any locomotive. At least two car lengths must separate the locomotive from the powder car.

(18) Do not transport explosive materials on a man haul trip.

(19) Pull, do not push, the car or conveyance containing explosive materials whenever possible.

(20) Place a reflectorized sign on every powder car or conveyance. The sign must be reflectorized with a sharply contrasting background and the word "EXPLOSIVES" in letters not less than 4 inches (10.2 cm) in height on each side.

g. Handling of Explosive Materials. (29-8.g)

(1) Do not smoke or use open lights or fire of any kind within 50 feet (15.2 m) of any area where explosives are being handled. Ignition sources, except necessary means to light fuses or fire electric detonators, are not permitted in an area containing loaded holes.

(2) Use only non-sparking tools or instruments to open containers of explosive materials. Metal cutters may be used for opening fiberboard boxes, paper bags or plastic tubes.

(3) Remove explosive materials from containers only as they are needed for immediate use.

(4) Separate explosive materials and detonators or primers must and take to the blasting area in original containers, Type 3 magazines, or containers according to 49 CFR 177.835.

(5) Do not make up primers in advance or in excess of the immediate need for a hole being loaded.

(6) Do not make up primers in or near magazines or excessive quantities of explosive materials.

(7) After loading, remove all excess explosive materials and detonators to a safe location or return them at once to the storage magazines. Follow the same rules as when conveying them to the blasting area.

(8) Do not take more explosive materials to an underground loading area than the amount estimated to be necessary for the blast.

(9) Take detonators into pressure working chambers separately from the other explosive materials.

h. Underground Blasting. (29-8.h)

(1) Develop and submit a Master Blasting Plan for underground blasting (see para 29-7.b).

(2) Explosives.

(a) Only use Fume Class 1 explosives in tunnel blasting. Fume Class 2 or Fume Class 3 explosives may be used only if adequate ventilation is provided. Only a qualified/licensed Blaster will handle explosives.

(b) It is prohibited to store explosives, blasting agents, or detonators in tunnels or underground work areas.

(3) Blasting Circuits.

(a) Utilize a power blasting switch system for all underground blasts.

(b) Install sectioning switches, or equivalent, in the firing line at 500 feet (152.4 m) intervals.

(4) Loading.

(a) Disconnect all power, water, and air lines from the loading jumbo prior to loading. Relocate existing power lines, including lighting circuits, a minimum of 50 feet (15.2 m) from the loading jumbo.

(b) Illuminate the loading area to a minimum of 10 foot-candle (108 Lux), when measured 50 feet (15.2 m) from the face. If additional illumination is needed, equip the loading crew with head lamps approved by a NRTL for the environment where they will be used.

(c) Equipment used for pneumatic placement of non-cap-sensitive blasting agents must be designed for that purpose and must be grounded while in use.

(5) Blasting.

(a) A QP must inspect the underground supports in the blast area after each blast. Secure deficient supports before resuming work. Inspect the rock surfaces and scale the crown and walls to remove loosened pieces. If required, provide shoring, bracing, rock bolts, shotcrete, or chain-link fabric, before mucking. Prior to drilling the next round, test the rock bolts located within 100 feet (30.5 m) of the previous blast.

(b) Wet down the muck pile prior to mucking and keep it wet during mucking operations.

i. Electromagnetic Radiation. (29-8.i)

(1) Do not perform blasting operations or store electric detonators in the vicinity of operating RF transmitters or other RF producing devices, except where the clearances according to IME SLP-20 can be maintained.

(2) Use an approved non-electric initiation system when performing blasting operations according to the manufacturer's instructions and system requirements.

j. Vibration and Damage Control. (29-8.j)

(1) Carefully plan, with full consideration of all forces and conditions involved, blasting operations in or adjacent to cofferdams, piers, underwater structures, buildings, structures, or other facilities.

(2) Establish a written plan for monitoring the operations prior to initiating vibration-controlled blasting operations (see para 29-7.c).

(3) Notify owners, occupants, and the public of the nature of blasting operations to be undertaken and controls that will be used as required by state and local ordinance.

(4) Where vibration damage may occur, limit the energy ratios and peak particle velocities to the levels set by the states or included in the NFPA 495 requirements, whichever is more stringent. An exception may be granted when approved by the USACE supervisor or accepted by the KO or COR; if an approved engineering analysis demonstrates that the proposed vibration exceedance will not cause damage and is safe. Suspend blasting when any recording exceeds either the energy ratio or peak particle velocity limits. Immediately notify the local SOHO, Blasting SME, USACE supervisor, KO or COR, and contractor designated authority (if applicable) of the exceedance and do not resume blasting until the cause has been determined and corrective measures taken.

(5) Where required by state regulations, determine scaled distances before each shot and included in the records. Do not exceed the scaled distances limitations set by the state.

(6) Do not exceed 133 dB (0.013 psi) air blast pressure on structures unless an engineering analysis, approved by the USACE supervisor or accepted by the KO or COR, demonstrates that the proposed air blast exceedance will not cause damage and is safe.

(7) A QP must monitor, record, and interpret the vibrations. Furnish a copy of records and interpretations to the USACE supervisor/KO or COR.

(8) Use vibration and/or air blast measuring equipment specifically designed and manufactured such purpose.

(9) Use appropriate blast holes patterns, detonation systems, and stemming to prevent venting of blasts and to minimize air blast and noise levels produced by blasting operations.

k. Drilling and Loading. (29-8.k)

(1) All drill holes must be large enough to freely allow for the insertion of the explosives.

(2) Do not drill in an area already blasted until remaining "bootlegs" are examined for unexploded charges and the total area has been examined to make sure that there are no unexploded charges remain.

(a) Never insert a drill, pick, or bar into bootlegs even if examination fails to disclose explosives.

(b) Do not drill holes where there is a danger of intersecting an undetonated hole, such as in an area where misfires have occurred.

(c) The Blaster-in-Charge must supervise drilling performed to neutralize misfires. The Blaster-in-Charge must be familiar with the conditions under which the misfired holes were drilled, loaded, primed, and initiated and with the drilling equipment capabilities that will be used during the neutralization.

(3) Do not conduct drilling and loading operations in the same area. Separate drilling from loaded holes by at least the depth of the loaded hole, but in no case less than 50 feet (15.2 m).

(4) Do not deepen drill holes that have contained explosives or blasting agents.

(5) Do not drill where a loaded hole might be disturbed or intersected.

(6) See chapter 18 for earth drilling requirements.

(7) Keep the blast site free of any equipment, operations, or persons not essential to loading. Do not permit vehicle traffic over loaded holes. Guard or barricade the blast site and post with danger signs to restrict unauthorized entry.

(8) Load only those holes that will be fired in the next round of blasting. After loading, immediately return all remaining explosive materials and detonators to an authorized magazine. Do not leave explosive materials or loaded holes unattended at the blast site at any time.

(9) Do not load sprung or jet-pierced holes until it is established that the hole has cooled sufficiently to safely load.

(10) Do not load or use explosive underground in the presence of combustible gases or combustible dusts unless a CP certifies in writing that the conditions of use

have been thoroughly identified and are safe. The CP must be qualified by a thorough knowledge of the factors to be evaluated or have been given written permission by the AHJ.

(11) Do not make-up primers in advance. Prime only the cartridges that will be used in the next round of blasting.

(12) Do not insert detonators in explosive materials that do not have a cap well without first making a hole in the cartridge with a non-sparking punch of proper size, or the appropriate pointed handle of a cap crimper.

(13) Seat cartridges only by even steady pressure.

(14) Tamp with wood rods having no exposed metal parts. Non-sparking metal connectors may be used for joint poles. A plastic tamping pole, approved by the USACE supervisor or accepted by the KO or COR, may also be used.

(15) Springing (that is, enlarging the bottom of a blasthole by firing a relatively small charge of explosive material) boreholes is prohibited.

(16) Use of Detonating Cord.

(a) Handle and use detonating cord with the same respect and care given other explosives, careful not to damage or sever cord during and after loading and hooking-up.

(b) When using a detonating cord down line and after the primer is loaded in the hole, cut the detonating cord from the supply reel before loading the rest of the charge.

(c) Detonating cord must be connected according to manufacturer's recommendation. Only use knot or other cord-to-cord connections with detonating cord when the explosive core is dry.

(d) All detonating cord trunk lines and branch lines must be free of loops, sharp kinks, or angles that direct the cord back toward the oncoming line of detonation.

(e) When connecting a detonator to detonating cord, tape or otherwise secure attach the detonators along the side of the detonating cord, with the end of the detonator containing the explosive charge pointing in the direction in which the detonation is to proceed.

(f) Do not bring detonators for firing the trunk line into the loading area nor attach them to the detonating cord until everything else is ready for the blast.

(17) The Blaster must keep an accurate, up-to-date record of explosives, blasting agents, and blasting supplies used in each blast.

(18) Stem loaded holes to the collar with non-combustible material.

(19) Where blasting may cause injury or damage by flying rock or debris, cover all charges with blasting mats or back cover them before firing. Where mats are used, take care to protect blasting lines.

(a) If flyrock leaves the blast area, cease all blasting until a report is filed by a QP. The report must explain the cause of the flyrock and the methods that will be employed on all subsequent blasts to reduce the throw of flyrock.

(b) If flyrock leaves the work site, cease all blasting operations until a QP reviews the blast site and determines the cause and solution to the flyrock program. Before blasting proceeds, submit a written report to the USACE supervisor for approval or to the KO or COR for approval.

l. Wiring. Wire electric initiation systems according to the Master Blasting Plan and the manufacturer's recommendations. (29-8.l)

m. Firing. (29-8.m)

(1) Prior to firing each shot, warn all persons in the blast area of the blast and order to a safe distance from the blast site. Do not fire blasts until it is certain that every person has retreated to a safe distance and no one remains in a dangerous location.

(2) Prior to firing each shot, a flag person must be posted at all access points of the blast area to prevent access.

(3) Prior to firing each shot, drill boats and other vessels must be moved to a safe distance from the blast area.

(a) Prior to and while the drill boat or vessel is being moved from the blast area, sound off a series of short signals by horn or whistle like the usual navigation warning signals.

(b) Do not fire any blast while any vessel under way is closer than 1,500 feet (457.2 m) to the underwater blasting area. Notify those onboard vessels or craft moored or anchored within 1,500 feet (457.2 m) before each blast is fired.

(c) Do not fire any blast closer than 250 feet (76.2 m) to a boat or vessel containing an explosive magazine. Personnel engaged in drilling operations on another drill boat within 500 feet (152.4 m) must leave the drill frames for cover if any holes have been loaded.

(d) Do not fire any blast while any swimming or diving is in progress near the blasting area.

(e) Whenever a drill boat is moved from the drilling location, fire all loaded under water holes.

(4) Safety Signals.

(a) All blasting operations must use the following safety signals:

(a-1) WARNING SIGNAL. A one-minute series of long audible signals made 5 minutes prior to the shot.

(a-2) BLAST SIGNAL. A series of short audible signals made 1 minute prior to the shot.

(a-3) ALL CLEAR SIGNAL. A prolonged audible signal following the inspection of each blast site.

(b) Make the safety signals using a compressed air whistle, a horn, or equivalent means. The signals must be clearly audible at the most distant point in the blast area. Do not use the boat whistle on a drill boat as a safety signal.

(c) Post the code for safety signals and warning signs and flags at all access points.

(d) Train individuals so they are familiar with the safety signals and instructions.

(5) The Blaster-in-Charge will make the lead line connections and fire the shot. Make all connections from the borehole back to the source of firing. Do not connect the lead line to the blasting machine or other source of energy until the charge is to be fired.

(6) After firing an electric blast, immediately disconnect the leading wires from the power source and shunted.

(7) When firing a circuit of electric blasting caps, take care to ensure that an adequate quantity of delivered current is available according to the manufacturer's instructions.

n. Post-Blast Procedures. (29-8.n)

(1) Immediately after each blast has been fired, disconnect the firing line from the blasting machine or power source and lock open all power switches. Test the atmosphere in each confined space and ventilate, as necessary.

(2) Do not permit anyone other than the Blaster-in-Charge to return to the blast area until the "all clear" signal is given.

(3) Scale down loose pieces of rock and other debris from the sides of the face of the blast site and make the blast area safe before proceeding with other work.

(4) Misfires.

(a) Handle misfires under the direction of the Blaster-in-Charge according to the procedures in the established Master Blasting Plan. The Blaster-in-Charge will determine the safest method for handling the hazards of misfires (some misfires may require consultation with the supplier or manufacturer of the explosive material).

(b) Do not perform other work within the misfired area except work that is necessary to remove the misfire hazard. Only those employees necessary to do the work may remain in the misfire area.

(c) Do not drill, dig, or pick near the misfire holes until they have been detonated or the Blaster-in-Charge has approved that work can proceed.

(d) Depending on the experience and ability of the Blaster-in-Charge, a secondary/dual initiation system to prevent misfires should be considered.

(e) When a misfire is declared, the Blaster must wait 30 minutes (cap and fuse 1-hour) before inspecting the site and provide proper safeguards for excluding all employees, except those necessary to do the work, from the blast area as defined in the Master Blasting Plan. The Blaster must establish the limits of the misfired area around the misfire according to the site-specific Master Blasting Plan.

o. Underwater Blasting. (29-8.o)

(1) A Blaster must conduct all blasting operations. No shot will be fired without their approval.

(2) Do not use loading tubes and casings of dissimilar metals because of possible electric transient currents from galvanic action of the metals and water.

(3) Use only water-resistant blasting caps and detonating cords for all marine blasting. Load through a rigid non-sparking loading tube.

(4) Display blasting flags.

(5) When more than one hole is loaded, anchor and float a steel shot line over the row of loaded holes. Tie the detonation down line from each loaded hole to the steel line and tie the loose end to the detonation trunk line.

(6) Include in the Master Blasting Plan the means and methods by which blast holes will be kept from intersecting when drilling near or adjacent to a loaded hole.

(a) Drill only vertical holes.

(b) If a casing, auger, or drill mast is used, it must be vertically plumbed at set up, when drill steel is added or every 5 feet (1.5 m) whichever is shorter, and upon completion. The casing, auger, or drill mast must extend from the barge and be firmly seated.

(c) Verify hole plumbness prior to loading.

(d) Abandon any hole that is out of plumb by more than three degrees from vertical and adjust adjacent hole spacing to prevent intersecting other holes.

(e) Halt drilling to check alignment with an inclinometer or approved device every 5 feet (1.5 m) of hole depth.

29-9. Figures and Tables.

Not Applicable.

29-10. Checklists and Forms.

Not Applicable.

Chapter 30 Diving Operations

30-1. References.

a. American Academy of Underwater Scientists (AAUS), Standards for Scientific Diving Manual (https://www.aaus.org/diving_standards) (30-1.a)

b. ANSI/Association of Commercial Diving Educators (ACDE)-01, Minimum Standard for Commercial Diver Training (<https://www.acde.us/standard.htm>) (30-1.b)

c. ACDE (<https://www.acde.us>) (30-1.c)

d. Association of Diving Contractors International (ADCI), Inc., International Consensus Standards for Commercial Diving and Underwater Operations (<https://www.adc-int.org/content.asp?contentid=173>) (30-1.d)

e. DoD Military Performance Specification (MIL-PRF)-27210 Oxygen, Aviator's Breathing, Liquid and Gas (https://quicksearch.dla.mil/qsDocDetails.aspx?ident_number=18723) (30-1.e)

f. ER 385-1-86, U.S. Army Corps of Engineers Dive Safety Program (<https://www.publications.usace.army.mil/USACE-Publications/Engineer-Regulations>) (30-1.f)

g. FAR Clause 52.236-13, Accident Prevention (<https://www.govinfo.gov/content/pkg/CFR-2020-title48-vol2/pdf/CFR-2020-title48-vol2-chap1-subchapH.pdf>) (30-1.g)

h. NOAA Nitrox Dive Tables (<https://www.oma.noaa.gov>) (30-1.h)

i. U.S. Navy Diving Manual, SS512-AG-PRO-010 (<https://www.navsea.navy.mil/Resources/Instructions>) (30-1.i)

j. U.S. Navy Guidance For Diving In Contaminated Waters, SS521-AJ-PRO-010 (<https://www.navsea.navy.mil/Resources/Instructions>) (30-1.j)

k. U.S. Navy Underwater Cutting and Welding Manual, S0300-BB-MAN-010 (<https://www.navsea.navy.mil/Resources/Instructions>) (30-1.k)

l. 29 CFR 1910 Subpart T, Commercial Diving Operations (<https://www.govinfo.gov/content/pkg/CFR-2020-title29-vol5/pdf/CFR-2020-title29-vol5-part1910-subpartT.pdf>) (30-1.l)

30-2. Definitions.

a. Actual Cubic Feet Per Minute (acfm). The actual volume of gas supplied to a diver, bell, etc., at ambient pressure. (30-2.a)

b. Bottom Time. The total elapsed time, measured in minutes, from the time when the diver leaves the surface in descent to the time the diver begins ascent. (30-2.b)

c. Contaminated Water. As related to underwater diving; water which contains any chemical, biological, or radioactive substance which poses a chronic or acute health risk to exposed personnel. Supervisory personnel are encouraged to contact local agencies to obtain information on local water contaminants and hazards. (30-2.c)

d. Designated Dive Coordinator (DDC). A USACE employee responsible for the appropriate oversight of a District, Fleet, Laboratory, Field Operating Activity (FOA), or Center Dive Safety Program. (30-2.d)

Note. For non-USACE contracting actions conducted under the FAR Clause 52.236-13 Accident Prevention, the DDC is the employee designated by the contracting authority to provide oversight for contractor diving plans and operations.

e. Dive Safety Inspector (DSI). An onsite government representative for contractor or USACE in-house diving operations. The DSI will assure dive team safety through coordination with the USACE supervisor/KO or COR and provide recommendations to correct deficiencies in the dive plan, AHA, or observed diving procedures. (30-2.e)

f. Diving, Direct Source Breathing Air Compressor. A machine that raises air or other gasses to a pressure above 1 atmosphere and supplies breathing air to a diver. (30-2.f)

g. Diving, Heavy Gear. Surface-supplied deep-sea diving gear including helmet (with or without breastplate), dry suit, and weighted shoes. The helmet is directly connected to the dry suit, forming a self-contained pressure envelope for the diver. (30-2.g)

h. Dive Safety Representative (DSR). A USACE / government employee assigned by the DDC and is normally the District SOHO representative who is assigned the responsibility of dive safety, provides dive safety advice, actively participates in the review and comment process for diving plans and hazard analyses, and onsite monitoring of diving operations. (30-2.h)

i. Diving Supervisor (DS). The person with the primary authority for any dive team's operation. Each dive team must have a designated DS to manage all aspects that affect the safety and health of dive team members. (30-2.i)

j. Helium-Oxygen (HeO₂). Breathing gas mixtures composed of helium and oxygen. (30-2.j)

k. Live Boating. A diving technique where a single surface-supplied diver performs work underwater while his hose is being tended from the bow of a vessel and while the vessel is being manually operated by the vessel master and is underway using its main propulsion system. (30-2.k)

l. Mixed-Gas Diving. A diving mode in which the diver breathes mixture other than air, (for example, HeO₂, Oxygen Enriched Air (OEA), nitrogen-oxygen (Nitrox). (30-2.l)

m. Nitrogen-Oxygen (Nitrox). Breathing gas mixtures ranging from 75 percent nitrogen/25 percent oxygen to 60 percent nitrogen/40 percent oxygen. (30-2.m)

n. Oxygen Enriched Air (OEA). A term often used to describe oxygen-rich mixtures. (30-2.n)

o. Penetration Dive. A dive that requires a diver to access an area that is both a physically confining space and one in which there is no direct access to the surface or bell for recovery of the diver from the water by the tender. (30-2.o)

p. Recompression Chamber. A pressure vessel for human occupancy such as a surface decompression chamber, closed bell, or deep diving system especially equipped to recompress, decompress, and treat divers. (30-2.p)

q. Scientific Diving. Diving performed solely as a necessary part of a scientific, research, or educational activity by employees whose sole purpose for diving is to perform scientific research tasks. Scientific diving does not include performing any tasks usually associated with commercial diving such as but not limited to placing or removing heavy objects underwater; inspection of pipelines and similar objects; construction; demolition; cutting or welding; or the use of explosives. (30-2.q)

r. Self-Contained Underwater Breathing Apparatus (SCUBA) Diving. A diving mode independent of surface supply in which the diver uses open-circuit self-contained underwater breathing apparatus. (30-2.r)

s. Surface Supplied Air (SSA). A diving mode in which the diver in the water is supplied from the dive location with compressed air for breathing. (30-2.s)

30-3. Personnel Required Qualification/Training.

a. Maintain training documentation according to 29 CFR 1910.410 (29 CFR 1910 Subpart T). Documentation must show dive team members, including dive tenders, have successfully completed training to the appropriate level (for example, SSA diver's certificate, surface supplied mixed-gas diver certificate). Copies of all dive-related training certificates are required. Such training must be provided by one of the following: (30-2.a)

(1) A commercial diving school, military school, federal government school, or an ACDE accredited school.

(2) An in-house training program that meets the requirements contained in ANSI/ACDE-01, or in the ADCI Consensus Standards.

(3) Training for Contractor Scientific Divers using compressed air SCUBA or SSA must be performed according to 29 CFR 1910.410 and must meet the above requirements or the training guidelines in the AAUS Standards for Scientific Diving. Training for USACE Scientific Divers must be performed according to ER 385-1-86.

(4) DSIs must hold current USACE training certification according to ER 385-1-86. All personnel used as DSIs must be approved by the DDC prior to performing inspector duties.

b. Proof of certification (that is, a diploma and/or official transcript) as a commercial working diver from an accredited commercial dive school or other dive-related training certificates (for example, chamber operator, saturation diver) is required for each dive team member. An ADCI card or similar certification from an internationally

recognized commercial diving organization may be substituted as proof of training for divers demonstrating more than five years of diving experience. (30-2.b)

c. Contractors must provide dive log evidence that each dive team member has training and experience consistent with the performance requirements of the scope of work. (30-2.c)

(1) As a minimum, each diver, back-up diver, and dive team supervisor must have at least one year of commercial experience in the applicable position.

(2) Divers must have completed at least four working dives with similar decompression techniques as in the dive plan, using the particular diving techniques and equipment. Divers must demonstrate that at least one of the four qualification dives were performed in the last nine months prior to the start of dive operations.

(3) Non-divers serving as dive tenders must have previous experience and training as a dive tender.

d. Each dive team member must have current certification in first aid and CPR (see chapter 3). (30-2.d)

(1) Additionally, each dive team member must have current certification in the use of emergency oxygen systems, and, if provided on the dive site, the use of an AED. See chapter 3 for AED requirements.

(2) All classes must contain a hands-on component and may not be taken online only. Evidence of this will be a photocopy of the certificates. The certificate(s) must state the date of issue and length of validity.

Note. Training in the use of emergency oxygen systems must meet the requirements of a nationally recognized training organization such as Divers Alert Network (DAN), Professional Association of Diving Instructors (PADI), National Association of Underwater Instructors (NAUI), the YMCA or other recognized sources.

e. Divers must receive an annual diving physical according to ADCI or similar standards by a hyperbaric physician (Doctor of Medicine (MD) or Doctor of Osteopathic Medicine (DO)) or other licensed physician knowledgeable in the physiology of diving. (30-2.e)

(1) A “Fit to Dive” statement that each diver has been medically examined within the previous 12 months and has been determined fit and approved to dive must be signed by the examining physician.

(2) The DDC must maintain a current file of physician “Fit to Dive” statement for all USACE qualified divers and divers-in-training.

(3) Contractors must submit physician's "Fit to Dive" statement to the DDC according to paragraph 30-7.a.

(4) After any serious diving-related injury or illness such as an over-pressurization injury and/or decompression illness, divers must be re-examined by a hyperbaric physician and be re-certified as "Fit to Dive".

f. Snorkelers. (30-2.f)

(1) All snorkelers and team members must be certified as skin divers (snorkelers) or open water divers by a nationally recognized organization.

(2) A licensed physician (DO or MD) must annually determine employees' medical fitness prior to snorkeling. This certification must be signed by a physician familiar with sports medicine and must state each snorkeler is physically and medically fit to perform snorkeling activities according to commonly accepted sports medicine guidelines. The contractor must submit such certification to the USACE supervisor for approval or to the KO or COR for acceptance.

(3) All snorkeling team members must be certified in first aid, CPR, emergency oxygen (O₂), and if provided onsite, the use of AEDs.

g. Equipment modifications, repairs, tests, calibrations, or maintenance must be performed by a certified technician according to the manufacturer's recommendations. The certified technician must show proof of training. (30-2.g)

30-4. Roles and Responsibilities.

a. Contract dive operations will follow the roles and responsibilities outlined in ADCI International Consensus Standards for Commercial Diving and Underwater Operations and this chapter. (30-4.a)

b. USACE dive operations will follow the roles and responsibilities outlined in ER 385-1-86 and this chapter. (30-4.b)

c. Dive Supervisor (DS). (30-4.c)

(1) Coordinate with the controlling authorities to minimize the hazards associated with water traffic, land-based traffic, industrial operations, heavy equipment operation, or other operations that present a hazard to the diver or dive team (see para 30-8.a(7)).

(2) Coordinate with the USCG to determine if there is a requirement to establish a safety zone.

(3) Develop site specific plans and procedures according to paragraph 30-7.

(4) Assure pre-dive checks are performed according to paragraph 30-5.

(5) Develop HEC procedures to protect dive teams from hazardous energy including but not limited to mechanical (for example, power transmission apparatus, counterbalances, springs, pressure, gravity), pneumatic, hydraulic, electrical, chemical, nuclear, and thermal energies (for example, high or low temperature). See chapter 12 and for pressure differentials see paragraph 30-7.

(a) When diving at a facility with an existing HEC procedure, the DS must review the facility's procedures and establish positive control procedures with the facility operator.

(b) If HEC procedures are required for the diving operation, the DS must visually check all LOTO and other control procedures and devices to ensure they are in place according to accepted procedure.

(6) For work involving LHE, review LHE signals and confirm radio communication with the LHE operator is functioning properly (see para 30-8.a(23)).

(7) When LHE manbaskets are used for diver access, ensure Critical Lift Plan are submitted according to chapter 16.

(8) Review welding or cutting procedures, select the proper welder polarity, and take precautions to ensure that electrocution will not occur (see para 30-8.a(24)).

(9) Review blasting procedures and take precautions to ensure unplanned or unscheduled blasts will not occur. See chapter 29 for additional blasting requirements.

(10) Conduct a pre-dive and post-dive briefing according to paragraph 30-8.a.

30-5. Inspection Requirements.

a. Contract diving operations must be monitored and/or inspected by personnel meeting the qualifications of DSI. DSIs must conduct onsite monitoring/inspections of contractor dive sites during pre-dive conferences, equipment inspections, and initial dives. Monitoring must be continuous for the duration of the contract dive activity, but may be intermittent as determined by the DDC based on an evaluation of the job complexity and degree of hazards. (30-5.a)

b. Individual USACE Dive Teams must be inspected during operations at least once annually by the DDC, or when designated, the Alternate Dive Coordinator (ADC), DSI, and/or DSR. (30-5.b)

Note. Use of trained monitors/inspectors with other credentials will be considered on a case-by-case basis and may be approved in writing by the DDC and USACE National Dive Safety Program Manager.

c. Prior to the dive, the DS must assure, as a minimum, the following pre-dive checks are performed: (30-5.c)

(1) Breathing air tanks contain sufficient air supply to perform the required work (that is, standby air tanks are onsite and full to the necessary capacity).

(2) All diving equipment functions properly prior to diver entry.

(3) All necessary safety equipment specified herein is onsite and functioning properly.

(4) LOTO procedures are followed.

d. Visually inspect SCUBA tanks internally at least annually and hydrostatically test them at least once every five years according to DOT and the CGA regulations. Stamp the hydrostatic test dates into the shoulder of each tank. (30-5.d)

30-6. Activity Hazard Analysis (AHA) Requirements.

Develop AHAs according to paragraphs 1-6 or 2-6, as applicable. When diving operations require the control of hazardous energy see paragraph 12-6.

30-7. Minimum Plan Requirements.

a. General Plan Requirements. (30-7.a)

(1) The following plans/documents are required for all diving operations (additional documentation may be required depending on the scope of the diving operation). Submit all documents to the USACE supervisor for approval by the DDC, or to the KO or COR for acceptance by the DDC, prior to commencement of diving operations. Always maintain a copy of these documents at the diving locations.

(a) Safe Practices Manual (see para 30-7.b).

(b) Dive Operations Plan(s) (see para 30-7.c).

(c) AHA to cover all aspects of the job (see para 30-6).

(d) Emergency Management Plan (see para 30-7.d).

(e) Dive Personnel Qualifications (see para 30-3).

(f) HEC Procedures when applicable (see para chapter 12).

Note. Two USACE Qualified Personnel independently must evaluate the documents prior to acceptance. The intent is for the DDC or ADC and DSR to accept all

documentation on a regular basis. However, due to potential personnel unavailability, a DSR is not required and can be substituted by a second DDC or ADC.

Note. Reviewers should be knowledgeable in the methodologies of the plan being reviewed or must consult with a SME to ensure the Dive Operations Plan and associated AHAs address the unique hazards associated with the dive.

(2) If for any reason the dive mission is altered:

(a) The DDC or ADC must review and accept minor to moderate revisions to the accepted dive plan prior to continuing the operation. These revisions may include differences in time, date, dive team members, work methods, tools used, and other changes that do not affect overall risk. This review may be conducted electronically or verbally and confirmed in writing after completion of the dive operation.

(b) A two-person review, as outlined in paragraph 30-7.a, is required for major changes or those which modify high-risk activities prior to continuing the operation or implementing new procedures. Major changes include modifying pressure differential and HECs adding penetration diving, changing dive equipment modes (that is, from SCUBA to SSA), discovering unexpected, contaminated diving conditions, etc. require a two-person review.

(3) Potential high-hazard conditions, such as penetration diving, contaminated environment diving, dives outside the no decompression limits, and in areas where differential pressure entrapment hazards exist, must be specifically addressed in the Dive Operations Plan and AHA when they are anticipated as part of the diving operation.

b. Safe Practices Manual. Contractors and USACE Districts/Fleets/Labs/FOAs/Centers with in-house dive teams must develop and maintain a Safe Practices Manual that encompasses their entire diving program. The Safe Practices Manual must be available at all times to the Government representative and all dive team members at each diving location. The Safe Practices Manual must include, as a minimum, the following: (30-7.b)

(1) Dive safety procedures and checklists.

(2) Assignments and responsibilities of dive team members.

(3) Equipment certifications, procedures, and inspection checklists.

(4) Emergency procedures for fire, equipment failure, adverse weather conditions, and medical illness or injury and specific procedures for:

(a) Procedures to deal with entrapped or fouled diver, including fouled umbilical (suction and entanglement/debris).

- (b) Actions upon loss of vital support equipment.
- (c) Actions upon loss of gas supply.
- (d) Actions upon loss of communication.
- (e) Lost diver plan (SCUBA Operations only).
- (f) Injured diver plan.
- (g) Actions upon discovery of fire.
- (h) Diver blow up or rapid ascent.
- (i) Diver loss of consciousness.
- (j) Injury or illness of member of surface crew with diver in the water.
- (5) Procedures for internal safety inspections (for example, frequency, checklists).
- (6) A complete copy of 29 CFR 1910, Subpart T, and a statement of the employer's policy for ensuring compliance with the standard.
- (7) The appropriate U.S. Navy Diving Manual, SS512-AG-PRO-010 table(s), including as a minimum:
 - (a) No-Decompression Limits and Repetitive Group Designation for No-Decompression Air Dives tables.
 - (b) Residual Nitrogen Timetables for Repetitive Air Dives.
 - (c) Standard Air Decompression table.
 - (8) A sample of the diving log sheets to be used.
 - (9) A sample of the repetitive dive worksheets or equivalent (dive profile method) to be used.
 - (10) An outline of the fitness for duty (including medical) requirements for dive team members.
 - (11) An outline of administrative and record-keeping procedures.
- c. Dive Operations Plan. This plan is a site-specific overview of all tasks to be performed, dive modes and equipment, site access, etc. Complex projects involving more than one work task, location, and/or dive team require task-specific dive plans as

part of the overall Dive Operations Plan. As a minimum, the Dive Operations Plan must contain the following: (30-7.c)

- (1) Date of dive plan submission.
- (2) Name and contact information for DS preparing the dive plan.
- (3) Names and duties of onsite dive team members, including DS.
- (4) List of diving equipment to be used.
- (5) Type of diving platform to be used.
- (6) Detailed description of the mission: Identify if and how work will be divided into separate tasks or phases of work.
- (7) Date(s), time(s), duration, and location of operation.
- (8) Diving mode used (that is, SCUBA and/or SSA) including a description of the back-up air supply, as required.
- (9) Diving methodology (for example, mixed-gas, Surface Decompression Using Oxygen (SUR D O₂)).
- (10) Nature of work to be performed by the divers, including tools used and materials to be handled or installed.
- (11) Anticipated surface and underwater conditions, to include visibility, temperature, currents, etc., and as appropriate, thermal protection.
- (12) Maximum single dive bottom time for the planned depth of dive for each diver. Calculate altitude adjustments to dive tables for dives made at altitudes of 1000 feet (304.8 m) or more above sea level.
- (13) Identification of topside assistance or support to the dive team (for example, crane operator, lock operator).
- (14) Means of direct communication between the dive site and the DDC, project office, the lockmaster or USACE PM, and the COR (if applicable).

(15) Description of the anticipated hazards or concerns and the control measures that will be implemented to control to an acceptable level to include but not limited to the following:

(a) For diving operations conducted in areas where pressure differentials may exist, the plan must be developed in coordination with the facility operator and address the following:

(a-1) Identification of all potential exposure points (for example, gate sills, valve openings, holes).

(a-2) Means for identifying whether control structures and mechanisms are fully in place (for example, measurements of stop gates and openings, valve indicators).

(a-3) Methods for checking pressure differential openings (for example, observing current/water flow, remote testing of opening area with objects such as rope, sandbags, cinders).

(a-4) Route the diver will take from staging area to work area. Include specific mitigations designed to prevent diver and umbilical from running into uncontrolled pressure differential openings.

(a-5) Procedures for immediate emergency pressure equalization or reduction, if possible.

(a-6) Procedures for emergency diver extraction or rescue due to pressure differential exposure, including standby diver deployment precautions.

Note. Potential or actual pressure differentials may occur in, but not limited to, locks, dams, spillways, powerhouses, hollow structures, and plant intakes.

(b) For diving operations conducted in contaminated water, the plan must specifically address the areas below according to SS521-AJ-PRO-010:

(b-1) Types of contaminants and contaminated water categories (CAT 1, 2, 3, 4).

(b-2) Levels of protection and protective equipment required.

(b-3) Contaminated water diver and topside personnel training and qualifications.

(b-4) Sources of information used to determine water quality.

(b-5) Dive Station Decontamination Procedures for Divers and Topside Personnel.

(b-6) Medical evaluation support and post dive monitoring.

(b-7) Hazardous waste minimization and disposal.

Note. Hazard scenarios and control measures must be considered for surface, mud-line and sediment, rainfall, points of discharge, and vertical and bottom water contamination (that is, a diver walking, crawling, or working, to include swim fin action that stirs up bottom sediments) as applicable to the operation.

(c) For diving operations involving surface decompressions with oxygen (SUR D O₂) and/or 100% oxygen, the plan must include oxygen-specific decompressions procedures and schedule.

(16) Plans submitted for Contractor operations must also include the name of contractor (and diving subcontractor if applicable), contract number, and names and contact information for key personnel.

Note. Include the following statement in the Dive Operations Plan: "If for any reason the dive plan is altered in mission, depth, personnel, or equipment, the DDC must be contacted in order to review and accept the alteration prior to actual operation."

d. Emergency Management Plan. Prepare an Emergency Management Plan for each dive operation. The plan must include, as a minimum, the following: (30-7.d)

(1) Location and phone number of nearest operational recompression chamber, if not located at the dive site, and the DAN emergency hotline number (919-684-9111).

(2) Location, directions to, and phone number(s) of nearest hospital(s) or available physicians capable of treating dive injuries.

(3) Location and phone number of nearest USCG Rescue Coordination Center, where appropriate.

(4) Emergency victim transport procedures including phone numbers of appropriate emergency transport services.

(5) Procedures and phone numbers or other means of communications to activate emergency services at the facility where the work is being performed.

(6) Diver rescue procedures conducted by the dive team, including responsibilities of team members, best location(s) where injured divers may be removed from the water, and best location(s) for performing first aid and stabilization prior to emergency medical support arrival.

e. Snorkeling Plan. Develop a Snorkeling Plan based on the requirements of paragraphs 30-7.b(1) through 30-7.b(5). It must contain, as a minimum, the following: (30-7.e)

(1) An AHA for each specific snorkeling mission. Give particular attention to currents and other environmental considerations. (See para 28-6)

(2) Records for snorkeling activities, to include:

(a) Snorkeler's annual physician certifications.

(b) Emergency Management Plan.

30-8. General Requirements.

a. Diving Operations. (30-8.a)

(1) Perform all diving operations according to this manual. Failure to meet these requirements will be cause for rejection of plans or cessation of operations.

(2) Coordinate requests for waivers or variances with the local DDC or ADC and according to the requirements of this manual.

(3) Do not use diving as a work method if the work objective can be more safely and efficiently accomplished by another means, including but not limited to, using Remotely Operated Vehicles (ROVs), and/or camera systems, or by dewatering the work area so work may be accomplished in the dry.

(4) Use SSA whenever possible according to the practical constraints of the diving operations.

(5) Do not use live boating without prior specific acceptance by the DDC.

(6) When diving at altitudes between 1,000 and 10,000 feet (304.8 to 3048 m), use the U.S. Navy Dive Manual SS512-AG-PRO-010 table to obtain decompression obligation.

(7) All dive operations must be conducted with full knowledge and close coordination with the USACE supervisor/KO or COR and onsite authorities such as the DSI, lockmaster, PM, etc. to ensure external operations and processes do not impact the safety of the dive.

(8) Key personnel designated by the DDC must attend a Pre-Dive Conference prior to the initial work on each dive operation. The conference agenda must include a discussion of the Dive Operations Plan, AHA, Emergency Management Plan, and any necessary plan modifications. For contractor operations, the DSI or DDC and a

representative of the contractor, with sufficient authority to implement any changes by the DSI or DDC, must attend.

(9) The DS must conduct a Pre-Dive Brief. The entire dive team must be briefed in detail on the following (as a minimum) prior to each dive:

(a) Description of mission and location, including drawings and/or photographs pertinent to the mission and equipment and materials that are to be installed as part of the mission.

(b) Description of diving apparatus/equipment and craft to be used.

(c) Maximum working depth with estimated bottom times and water temperatures.

(d) Names and duties of personnel on the team. When possible, incorporate at least one person on the dive that has previously performed the same or similar mission.

(e) Discussion of AHA.

(f) Emergency procedures.

(10) The DS must conduct a Post-Dive Brief. The entire dive team must be briefed upon completion of each diving operation or at the conclusion of each day on (as a minimum) the following information and requirements:

(a) Advise divers of the location of the nearest recompression chamber (if not located onsite), and the emergency hotline number for DAN or the local dive medical facility. Additionally, caution them on the limitations of their post dive activities including repetitive dives, traveling to higher altitude, and flying.

(b) Divers must wait at least 12 hours before flying after any dive. Divers must wait at least 24 hours before flying after multiple days of repetitive dives.

(11) Staff all dive teams according to the tables 30-2 through 30-6.

(a) The DDC may increase the levels after considering the diving and snorkeling support systems, the task at hand, weather conditions, dive/snorkeling platform type and location, and other factors.

(b) Team members may rotate through the dive or snorkeling team positions as long as the minimum staffing levels are maintained, and team members are qualified and accepted for the position.

(12) Submit copies of the dive logs to the DDC and COR after completion of the dive operation. For USACE dive teams, maintain these records on file for the time

period the employee is in the dive program and an additional two years after the employee has left the dive program.

(13) For each diver and dive, the following dive log information, as a minimum, must be recorded and maintained at the dive location:

- (a) Full name.
 - (b) Date, time, and location of dive.
 - (c) Maximum depth and bottom time.
 - (d) Surface interval between dives.
 - (e) Breathing medium and type of equipment used.
 - (f) Group classification at the beginning and end of each interval and repetitive dive worksheet.
 - (g) Underwater and surface conditions.
 - (h) Depth and duration of each decompression stops.
 - (i) Date and time of last previous dive if it occurred within the last 24 hours.
 - (j) Name of DS(s) during dive.
 - (k) General description of work performed.
 - (l) For dives outside the no-decompression limits, deeper than 100 feet salt water (fsw) (30.5 m), or using mixed-gas, include depth-time and breathing-gas profiles and decompression tables (including any modifications).
 - (m) For each dive in which decompression sickness and/or pulmonary barotraumas is suspected, or symptoms are evident, the following information must be recorded and maintained:
 - (m-1) Descriptions of signs and symptoms (including depth and time of onset).
 - (m-2) Description and results of treatment.
 - (m-3) Name, address, and phone number of attending physician.
- (14) Provide the following emergency and first aid equipment at all dive sites:
- (a) A first aid kit meeting the requirements of chapter 3.

(b) An oxygen resuscitation system for each diver, to include standby diver(s), that delivers oxygen (O₂) for a minimum of 30 minutes at a rate of 15 liters per minute (lpm) or until emergency medical assistance can be administered. The system must contain a pocket mask with O₂ inlet, non-rebreather mask, and demand inhalator and/or demand resuscitator.

(c) A stokes litter or backboard, equipped with at least four body straps, snap buckles, and a head block, and have flotation capability.

(15) When diving from vessels, display International Code flag "A" and recreational dive flags with a minimum dimension of 23 inches (58.4 cm) a minimum of 3 feet (0.9 m) above the working surface at the dive location during diving operations. When diving from surfaces other than vessels in areas capable of supporting marine traffic, display a rigid replica of the International Code flag "A" at least 3 feet (0.9 m) in height at the dive location in a manner which allows all-round visibility, and illuminate it during night diving operations.

(16) When diving SSA from anchored vessels, the vessel must use no less than a two-point anchorage system.

(17) Select and configure staging areas, where the fully suited and equipped diver enters the water, based on a hazard analysis that includes an examination of the following:

(a) Ease of diver access to the water.

(b) Hazards to diver (for example, currents, equipment) in route from surface to work area.

(c) Ability of standby diver to access the water immediately and to reach the diver quickly.

Note. If diver entry to water is remote from the staging area, locate the standby diver at the water entry or at a spot immediately accessible to it.

(d) Ability to protect members and the standby diver from weather, operational, and other hazards located at the topside dive team station.

(e) Whether topside equipment can be stowed safely and function properly.

(18) Provide a standby diver whenever there is a diver(s) in the water, to serve as immediate emergency assistance to the primary diver(s).

(a) Untethered SCUBA divers, working in "buddy" pairs, must have one tethered standby diver at the surface for each pair.

(b) A standby diver will deploy only after the DS assesses the situation and gives direction.

(c) Fully equip the standby diver for immediate deployment the entire time the primary diver is in the water.

(c-1) The standby diver must don all specific gear (suits, harnesses, and equipment) they must wear or use and test all of it for proper operation before the primary diver leaves the surface.

(c-2) The standby diver must not assume other work responsibilities other than communications with the primary diver unless all the conditions in table 30-4 are met.

(c-3) Maintain all gear operational and ready for immediate use for the duration of the dive. The standby diver must don and test gear that is exchanged or replaced during the dive.

(d) The standby diver must be dressed appropriately for the water and air temperature and remain fully suited up with helmet or mask ready for immediate donning from the time the primary diver leaves the surface until reaching the work area or working depth. The standby diver may remove the portions of their gear needed to prevent heat or cold stress and fatigue. If the AHA identifies a need for the standby diver to remain fully dressed to deploy, it must address measures that will be taken to control these hazards (for example, standby in water at surface). Any gear that has been removed must be maintained ready for immediate donning and use, and accessible to the standby at the entry to the water.

(e) If configuration of the surface staging area prevents safe, immediate entry of the standby diver into the water, position the standby diver in the water fully dressed. The standby diver must remain at the surface ready for deployment prior to the primary diver leaving the surface.

(19) Dives that require surface decompression as an integral part of the dive operation must have a trained chamber operator, whose sole purpose is to attend to the chamber operation. When recompression capability is required on station, the recompression chamber must be in compliance with the requirements of 29 CFR 1910.423 (29 CFR 1910 Subpart T).

(a) In dive operations where use of the chamber is required for emergency, first aid, or other unexpected recompression events, all diving must be suspended during the chamber operations.

(b) Whenever a chamber is onsite, the chamber operator must be capable of communicating with a diving physician.

(c) Divers completing a decompression dive must remain within 60 minutes travel of a fully operable and staffed recompression chamber for a minimum of two hours after completing the decompression dive.

(20) Power Tools. Test and certify hand-held power tools are safe for underwater use. These tools must be de-energized at the surface before being placed into or retrieved from the water and must not be supplied with power until requested by the diver.

(21) Underwater Excavations. Perform underwater excavation operations according to ADCI International Consensus Standards for Commercial Diving and Underwater Operations.

(22) Contaminated Water.

(a) Diving in contaminated water is prohibited for all personnel unless supporting documentation is provided that demonstrates divers and topside personnel are not exposed to, or will be protected from, known or potential contamination hazards that would pose a chronic or acute health risk (see para 30-7.c).

(b) All divers and topside personnel must provide evidence of training and experience with contaminated water operations prior to actual diving operations (see paras 30-3.b and c).

(23) Crane operations conducted to support diving operations must be performed according to chapter 16 of this manual.

(a) Perform all working dives requiring communications between the divers and topside to direct crane load movements, etc., in SSA mode.

(b) The crane operator must take instruction from the tender or supervisor who is in direct communication with the diver.

(c) Crane operations where the load is placed or removed while a diver is underwater are considered Critical Lifts. The diver or load director must participate in the Critical Lift Plan development according to chapter 16.

(d) Divers performing rigging duties must be qualified riggers and meet the personnel qualifications according to chapter 15.

(24) Underwater Welding and Burning Operations. See chapter 10 for additional requirements.

(a) Underwater welding and burning operations are limited to SSA mode only.

(b) Equipment configuration and procedures must be according to the U.S. Navy Underwater Cutting and Welding Manual, S0300-BB-MAN-010.

(c) Divers performing underwater welding and burning operations must be equipped with the following as a minimum:

(c-1) A rubber or neoprene dive suit in good condition that provides electrical insulation to the diver.

(c-2) Insulating gloves with a cuff that, as a minimum, reaches and fully covers the wrist.

(c-3) A welding or burning eye shield attached to the dive helmet with appropriate shade for the conditions at the working area. See chapter 5 for helmet requirements.

b. SCUBA Operations. (30-8.b)

(1) SCUBA diving operations are not permitted in any of the following scenarios:

(a) At depths greater than 100 feet (30.5 m).

(b) On dives outside the no-decompression limits unless a dual lock, multi-place, recompression chamber in compliance with the requirements of 29 CFR 1910.423 (29 CFR 1910 Subpart T) is available at the dive location and is immediately available for use, a trained competent operator is onsite, and the chamber is of sufficient size to accommodate the diver as well as an inside tender.

(c) Against currents exceeding one knot.

(d) In enclosed or physically confining spaces. See chapter 34 for confined space requirements.

(e) Using closed circuit or semi-closed-circuit SCUBA.

(f) In visibility less than 3 feet (0.9 m) unless line tended with diver to surface two-way voice communications.

(g) In areas where pressure differentials exist and it cannot be positively verified that all potential leaks have been eliminated.

(h) When the diver does not have direct access to the surface.

(2) Specific operational requirements for SCUBA operations are as follows:

(a) The minimum sized SCUBA tank allowed as primary air is a standard 80 ft³ aluminum tank pressurized to at least 2,700 psi at the beginning of dive operations.

Note. Divers must terminate their dive so they reach the surface with a minimum tank pressure of 500 psi.

(b) Equip each diver with a minimum 30 ft³ bailout bottle for emergency use pressurized to at least 90 percent of its working psi rating and equipped with a separate 1st and 2nd stage regulator. An “octopus” is not considered to be an alternate air source.

(c) SCUBA air cylinders must be inspected according to paragraph 30-5 and comply with the following requirements:

(c-1) Air cylinders of seamless steel or aluminum must meet DOT 3AA and DOT 3AL specifications.

(c-2) Each cylinder must be stamped identification symbols into the shoulder of the tank.

(d) Equip each diver with a buoyancy compensation device having a manually activated inflation source, an oral inflation device, and an exhaust valve.

(e) Equip each SCUBA diver with a submersible cylinder pressure gauge capable of being monitored by the diver during the dive.

(f) Equip each SCUBA diver with a weight belt or assembly capable of quick release.

(g) Equip each SCUBA diver with a depth gauge and knife.

(h) Use a timekeeping device for recording diving times for all SCUBA diving operations. The DS and diver must each have a timekeeping device.

(i) Each tethered SCUBA diver must wear a safety harness with a positive buckling device, attachment point for the safety line, and a lifting point. The safety harness must distribute the pull force of the line over the diver's body while maintaining the body in a heads-up vertical position when unconscious or inert. Tethered SCUBA diver must be line-tendered from the surface.

(j) Each untethered SCUBA diver must be accompanied by another diver in the water in continuous visual contact.

c. Surface Supplied Air (SSA) Operations. (30-8.c)

(1) SSA operations must not be conducted at depths greater than 190 feet (57.9 m), except dives with bottom times of 30 minutes or less may be conducted to depth of 220 feet (67 m). Do not conduct exceptional exposure dives, as defined by the U.S. Navy Diving Manual, except in emergency lifesaving situations. USACE in-house SSA operations must not exceed a planned depth of 110 feet (33.5 m) unless a waiver is requested by the DDC and approved by the USACE National Dive Safety Program Manager.

(2) SSA equipment components must be a type specifically designed to be used in diving support systems.

(3) A recompression chamber must be available for all SSA operations when diving outside the decompression limits, utilizing mixed-gas, and/or when diving at or deeper than 100 feet (30.5 m) is planned.

(a) Under these conditions, a dual lock, multi-place, recompression chamber in compliance with the requirements of 29 CFR 1910.423 must be available at the dive location immediately available for use.

(b) The chamber must be of sufficient size to accommodate the diver as well as an inside tender, and a trained chamber operator must be immediately available.

(c) Sufficient oxygen must be available to complete chamber operations. Oxygen used for diver's breathing at 100% concentrations and for mixing of diver's breathing gases must meet MIL-PRF-27210. Oxygen quality standards are as follows:

Note. Gaseous and liquid oxygen must contain not less than 99.5% by volume. The remainder, except for moisture and minor constituents specified below, must be argon and nitrogen.

(c-1) Oxygen (percent by volume) must not be less than 99.5%.

(c-2) Oxygen must not contain a level of CO₂ (by volume) greater than 10 ppm.

(c-3) Oxygen must not contain a level of methane (CH₄ by volume) greater than 50 ppm.

(c-4) Oxygen must not contain a level of acetylene (C₂H₂) greater than 0.1 ppm.

(c-5) Oxygen must not contain a level of ethylene (C₂H₄) great than 0.4 ppm.

(c-6) Oxygen must not contain a level of ethane (C₂H₆ and other hydrocarbons) greater than 6.0 ppm.

(c-7) Oxygen must not contain a level of nitrous oxide (N₂O by volume) greater than 4.0 ppm.

(c-8) Oxygen must not contain a level of halogenated compounds (by volume) as refrigerants greater than 2.0 ppm.

(c-9) Oxygen must not contain a level of halogenated compounds (by volume) as solvents greater than 0.2 ppm.

(4) Use a bell for dives with an in-water decompression time greater than 120 minutes, unless heavy gear is worn, or diving is conducted in physically confining spaces.

(5) Minimum specific operational requirements for SSA diving operations are as follows:

(a) Continuously tend each diver while in the water, with one diver per tender, regardless of depth. The tender must not perform any other duties outside of tending the diver, except as allowed by tables 30-2 through 30-8.

(b) Station an underwater tender/diver at the immediate underwater point of entry when any overhead obstruction limiting direct access to the surface is present and/or penetration diving is conducted or when in an enclosed or physically confining spaces.

(c) Provide a primary breathing air supply for each diving operation sufficient to support divers for the duration of the planned dive, including decompression.

(d) Each diver must have a reserve breathing supply available that can be turned on immediately by the diver in the event of loss of air. The reserve breathing air supply must have its own underwater submersible pressure gage with a 36 inch (91.5 cm) hose. The air supply must be of sufficient capacity to recover the diver and complete emergency recompression, if required, in the event of loss of primary air. The supply tank must contain no less than 30 ft³ (0.85 m³) of air pressurized to at least 90% of the tank's working psi at the beginning of the dive.

(e) Each dive location must have a reserve breathing air supply integral or in-line with the primary air source sufficient to safely terminate the dive and recover the diver(s) in the event of loss of the primary air supply.

(f) Provide the standby diver with a spare air supply hose on dives deeper than 100 feet (30.5 m) or outside the no decompression limits and using heavy gear. The spare hose is a replacement for the primary diver's air hose should it become damaged. Provide an in-water support stage to divers when using heavy gear, regardless of depth.

(g) Incorporate electronic communication systems with an external speaker so the entire dive team can monitor communications.

(g-1) Test communications devices prior to each dive, maintain them in an operable condition, and protect them from damage during use and storage according to the manufacturer's instructions.

(g-2) If voice communications are lost, terminate dive operations in a safe, orderly fashion using line-pull signals.

(g-3) Do not allow defective electronic communication equipment to prevent a standby diver from deploying in an emergency. However, deploy only after the DS determines it is safe to dive and use line-pull signals as appropriate.

d. Mixed-Gas Diving Operations. (30-8.d)

(1) For mixed-gas dives, provide a fully functioning dual lock, multi-place, recompression chamber with a trained, competent operator. Provide sufficient oxygen to complete chamber operations. The recompression chamber must be capable to conduct decompression following the mixed-gas decompression tables in the U.S. Navy Diving Manual. Do not perform extreme depth, mixed-gas diving.

(2) Equip each diving operation with a primary breathing gas supply sufficient to support divers for the duration of the planned dive, including decompression.

(3) Equip each diving operation with a reserve breathing gas supply integral or in-line with the primary air source sufficient to safely recover the diver(s) in the event of failure of the primary breathing gas supply.

(4) The primary and reserve breathing gas supply must be capable of delivering the mixed-gas requirements. For example, when performing mixed-gas helium-oxygen according to the U.S. Navy Surface-Supplied Helium-Oxygen Decompression Tables, the diving system must be capable of supplying the diver's umbilical with four different breathing gasses: Bottom Mixture; 50% Helium 50% Oxygen; 100% Oxygen; and Air.

(5) SUR D O₂ and/or 100% oxygen in-water decompression by trained and certified dive teams, may only be authorized as a decompression methodology upon submittal of an oxygen-specific decompression plan and schedule as part of the dive operations plan, and only with the expressed written approval of the DDC or ADC (see para 30-7.c).

(6) When heavy gear is worn provide the following:

(a) Provide each standby diver with an extra hose capable of supplying breathing gas to the diver in the water.

(b) Provide each diver with an in-water stage.

(7) For divers without access to a bell for dives deeper than 100 feet (30.5 m) or outside the no-decompression limits, provide an in-water stage.

(8) When a closed bell is used, one dive team member in the bell must be available to tend the diver in the water.

e. Oxygen Enriched Air (OEA). (30-8.e)

(1) USACE National Dive Safety Program Manager must approve any use of OEA such as Nitrox (EANx) breathing mixtures, and the associated equipment, by USACE in-house dive teams. Provide a written program that identifies training, certification, and procedures for OEA use with the request for approval. The DDC must approve use of OEA by contractors.

(2) Properly mark bottles used for OEA breathing mixtures.

(3) Follow, without exception, the U.S. Navy or NOAA Nitrox Dive Tables for the OEA mixture being used. Other more conservative decompression tables may be used after acceptance by the DDC.

(4) The use of OEA/EANx is considered mixed-gas diving and requires a decompression chamber onsite and ready for use.

(5) All divers must provide evidence of training and experience with OEA breathing mixtures prior to actual diving operations (see para 30-3).

(6) Test OEA breathing mixtures to assure proper mix prior to each use. No more than 40% OEA is allowed for normal diving operations. Higher OEA concentrations are allowable for in-water decompression at shallow safety stops.

f. Equipment Requirements. (30-8.f)

(1) Equipment modifications, repairs, tests, calibrations, or maintenance must be recorded by means of a tagging or logging system, and include the date and nature of work performed and the name of the individual performing the work. All work must meet manufacturer recommendations and be performed by a certified technician. (See para 30-3.g)

(2) Breathing Air Compressors.

(a) Direct source breathing air compressor systems must be designed for their intended use and be equipped with a volume tank with check valve on the inlet side, a pressure gauge, a relief valve, drain valve and a low-pressure alarm.

(b) Direct Source breathing air compressors must overcome any line loss or other losses and deliver a minimum 4.5 acfm (2.1 l/s), or an amount acfm specified by the helmet manufacturer, to each diver at the maximum diving depth.

(c) Equip all direct source breathing air compressors with a CO monitor with alarm when powered by or used in close proximity to internal combustion engines (for example, boat motors, generators, cranes).

(d) Design all monitor/alarm systems with a visual and/or audio alarm and locate so the DS will be made aware of the hazardous conditions.

(e) Locate all breathing air compressor intakes away from and upwind of areas containing exhaust or other contaminants.

(f) Do not use oil-lubricated breathing air compressors containing a petroleum or potentially CO producing piston lubricant.

(g) Do not fuel an operating breathing air compressor.

(h) Equip breathing air compressors with appropriate in-line air purifying absorbent beds and/or filters inserted into the supply line to assure breathing air quality.

(i) Test each breathing air compressor by sampling at the connection to the distribution system.

(i-1) Have an accredited testing laboratory test all breathing air compressors with a working pressure greater than 500 psi every six months. Lab accreditation must be from a National Institute of Standards and Technology/National Voluntary Laboratory Accreditation Program, American Association of Laboratory Accreditation (for environmental or calibration), or similarly accredited organization.

(i-2) Have an accredited testing laboratory test all breathing air compressors with a working pressure less than 500 psi every two years. Perform in-house testing every six months.

(j) Provide the USACE supervisor/KO or COR with a copy of air quality certifications for all onsite direct source breathing air compressors and offsite suppliers showing the air meets the following purity standards:

(j-1) Air must not contain a level of CO greater than 10 ppm.

(j-2) Air must not contain a level of CO₂ greater than 1,000 ppm.

(j-3) Air must not contain a level of oil mist greater than 5 mg/m³.

(j-4) Air must not contain a level of hydrocarbons other than methane greater than 25 ppm.

(j-5) Air must not contain a noxious or pronounced odor.

(3) Breathing Air Supply Hoses and Umbilicals.

(a) Breathing air supply hoses must be suitable for breathing gas service or must be specifically manufactured for SSA use. Hoses must have a maximum allowable working pressure equal to or greater than supply pressure plus 150 psi.

(b) Breathing air supply hoses must have connectors made of corrosion resistant materials with a working pressure at least equal to the working pressure of the hose to which they are attached: connectors must not be able to become accidentally disengaged. All system hoses must have a lanyard strain-relief attaching the hose to equipment to prevent the hose from whipping should the hose burst.

(c) Umbilicals must be marked, beginning at the diver's end, in 10 feet (3 m) increments to 100 feet (30.5 m) and in 50 feet (15.2 m) increments thereafter (see table 30-1).

(d) Umbilicals must have a nominal breaking strength of 1000 lbs. (453.6 kg) and must be made of kink resistant materials.

(e) The umbilical assembly used for the standby diver must be at least long enough to reach the primary diver at the furthest distance the primary diver can be from the dive station.

(f) Carefully tend the umbilicals to maintain them and the diver clear of hazards (such as propellers, including those of ROVs, or intakes) present in the diving zone.

(g) Test hoses to 1.5 times the working pressure prior to placing into initial service and after any repair, modification, or alteration, and at least every 12 months. Maintain and test umbilical assemblies according to the manufacturer's instructions.

(h) Close and cap the open ends of the breathing gas hoses and umbilicals when not in use.

(4) SSA And Mixed-Gas Helmets and Masks.

(a) Helmets and masks must have an exhaust valve and non-return valve that readily close at the attachment between the helmet or mask and the hose.

(b) Helmets and masks must have a minimum ventilation rate capacity of 4.5 acfm (2.1 l/s) at the depth at which they are operated.

(c) Helmets and masks must support a reverse breathing supply which can be immediately turned on by the diver in event of loss air.

(d) Helmets and masks must support a two-way or four-way diver surface communication system.

(e) The use of Kirby Morgan Super Lite 17 A/B helmets are prohibited for use by USACE in-house dive programs. This helmet can be used by commercial dive contractors on USACE projects provided the helmet has been inspected and is equipped with the required and recommended safety equipment.

(5) Dive Harnesses. Unless heavy gear is worn, each tethered diver must wear a diver's safety harness meeting ADCI standards with a positive buckling device, two leg straps, attachment point for the safety line, and a lifting point to distribute the pull force of the line over the diver's body while maintaining the body in a heads-up vertical position when unconscious or inert.

g. Scientific Snorkeling. (30-8.g)

(1) Plan all scientific snorkeling according to paragraph 30-7.e and paragraph 30-8.g.

(2) Beach surveys must follow applicable scientific snorkeling safety procedures and must be conducted only with prior acceptance of the DDC.

(3) Scientific snorkeling is only for environmental assessments, such as fish surveys, stream surveys, and the like. Structural inspections or other work is not allowed.

(4) All snorkelers and team members must meet the qualifications of paragraph 30-3.f.

(5) Staff all snorkeling teams according to the tables 30-7 or 30-8.

(6) DSIs will provide safety oversight for snorkeling operations.

(7) Perform scientific snorkeling only at the surface of the water. No diving of any kind is permitted.

(8) Untethered single person scientific snorkeling is not allowed.

(9) A team member must accompany each untethered snorkeler either along the shore or in a boat and be within 50 feet (15.2 m) of the snorkeler at all times.

(a) Two untethered snorkelers in the same body of water may act as observer/assistant for each other.

(b) Team members must utilize wearable and throwable PFDs according to chapters 5 and 19 and must be capable of performing a rescue on the specific snorkeler(s) in an emergency.

(10) Untethered scientific snorkeling is not allowed in waters deeper than 5 feet (1.5 m), in bodies of water that a snorkeler cannot wade across, in currents exceeding one knot, in visibility less than 3 feet (0.9 m), or anywhere a pressure differential may exist.

(11) The local DDC may allow scientific snorkeling in open waters greater than 5 feet (1.5 m) deep upon approval of an acceptable AHA and compliance with all the following:

(a) The snorkeler must be tethered with a harness and a maximum of 40 feet (12.2 m) of floating line.

(b) Constantly tend the tether from the shore or boat.

(c) The snorkeler must wear a device providing a minimum of 15.5 lbs. (7 kg) of positive buoyancy (for example, Type III PFD, fully inflated snorkeling vest). The device must include a divers safety harness with a positive buckling device, two leg straps, attachment point for the safety line, and a lifting point to distribute the pull force of the line over the snorkeler's body while maintaining the body in a heads-up vertical position when unconscious or inert. The snorkeler must use professional grade equipment that includes a snorkel, mask, gloves, fins, appropriate footwear, thermal protection, as needed, and a knife.

(d) There are no potential tether entanglement hazards in the snorkeling area (for example, overhanging branches, surface stumps, rocks).

(12) When snorkeling from anchored vessels, the vessel must use no less than a two-point anchorage system.

(13) When snorkeling from vessels, display International Code flag "A" and recreational dive flags with a minimum dimension of 23 inches (58.4 cm) a minimum of 3 feet (0.9 m) above the working surface at the snorkeling location during snorkeling operations. When snorkeling from surfaces other than vessels in areas capable of supporting marine traffic, display a rigid replica of the International Code flag "A" at least 3 feet (0.9 m) in height at the snorkeling location in a manner which allows all-round visibility, and illuminate it during night diving operations.

(14) The following emergency and first aid equipment must be located at all snorkeling sites:

(a) A first aid kit meeting the requirements of chapter 3.

(b) An oxygen resuscitation system for each snorkeler that delivers O₂ for a minimum of 30 minutes at a rate of 15 lpm or until emergency medical assistance can be administered. The system must contain a pocket mask with O₂ inlet, non-rebreather mask, and demand inhalator and/or demand resuscitator.

(c) A stokes litter or backboard, equipped with at least four body straps, snap buckles, and a head block, and have flotation capability.

(15) Provide a direct means of communicating with emergency services while snorkeling.

30-9. Figures and Tables.

**Table 30-1
Umbilical Markings**

Distance (from diver's end)	Marking
10 feet (3m)	<u>1</u> white band
20 feet (6.1m)	<u>2</u> white bands
30 feet (9.2m)	<u>3</u> white bands
40 feet (12.2m)	<u>4</u> white bands
50 feet (15.2m)	<u>1</u> yellow band
60 feet (18.3m)	1 yellow <u>band</u> / 1 white <u>band</u>
70 feet (21.3m)	1 yellow <u>band</u> / 2 white <u>bands</u>
80 feet (24.4m)	1 yellow <u>band</u> / 3 white <u>bands</u>
90 feet (27.4m)	1 yellow <u>band</u> / 4 white <u>bands</u>
100 feet (30.5m)	1 red band
150 feet (45.7m)	1 red <u>band</u> / 1 yellow <u>band</u>
200 feet (61m)	2 red bands
250 feet (76.2m)	2 red <u>bands</u> / 1 yellow <u>band</u>
300 feet (91.5m)	3 red bands

Note:

For each 50 feet (15.2 m) increment thereafter the sequence continues by increasing the number of red bands at each even increment of 100 feet (30.5 m). In cases where the umbilical color matches an above band color, a reasonable substitute may be used (contrasting outline on same-color tape, contrasting diagonal pattern, replacement with a color not already used).

**Table 30-2
Staffing Levels for SCUBA: Untethered, 0 to 100 feet (0 to 30.5 m)**

Personnel	Number
Diving Supervisor	1
Divers (in visual contact)	2
Standby Diver ¹	1
TOTAL <u>MINIMUM</u> TEAM	4

Note:
For applicable staffing level notes, see table 30-8.

**Table 30-3
Staffing Levels for SCUBA: Tethered with Communications, 0 to 100 feet (0 to 30.5 m)**

Personnel	Number
Diving Supervisor ³	1
Diver in water	1
Standby Diver ¹ (tethered with communications)	1
Tender	1
TOTAL <u>MINIMUM</u> TEAM	4

Note:
For applicable staffing level notes, see table 30-8.

**Table 30-4
Staffing Levels for SSA: 0 to 100 feet (0 to 30.5 m) within No Decompression Limits**

Personnel	Number	Penetration Dive
Diving Supervisor ³	1	1
Diver	1	2
Standby Diver ¹	1	1
Tender	1	2
TOTAL <u>MINIMUM</u> TEAM	4	6

Note:
¹ For applicable staffing level notes, see table 30-8.

² The standby diver may be deployed as a working diver provided all of the following conditions are met: surface-supplied no-decompression dive of 60 fsw or less; divers are in close proximity, (based onsite specific requirements), with unimpeded access to each other; divers have communications with each other at all times; No entanglement hazards exist; prior to deploying the standby diver, the first diver on the jobsite determines the work area to be free of hazards (for example, suction, discharges); the dive is not a penetration or confined space dive; and each diver has a full-time tender (which brings the minimum number of team members to five).

Table 30-5
Staffing Levels for SSA: 0 to 100 feet (0 to 30.5 m) Requiring Decompression and All SSA: 101 to 190 feet (30.8 to 57.9 m)

Personnel	Dives within No Decompression Limits	Dives Requiring Decompression	Penetration Dives
Diving Supervisor	1	1	1
Chamber Operator ²	1 ²	1 ⁴	1
Diver	1	1	2
Standby Diver ¹	1	1	1
Tender	1	1	2
Standby Diver Tender	1	1	1
TOTAL <u>MINIMUM</u> TEAM	5 or 6	5 or 6	8

Note:
For applicable staffing level notes, see table 30-8.

Table 30-6
Staffing Levels for Surface Supplied Mixed-Gas Diving

Personnel	Dives within No Decompression Limits	Dives Requiring Decompression	Penetration Dives
Diving Supervisor	1	1	1
Chamber Operator ²	1 ²	1 ⁴	1
Diver	1	1	2
Standby Diver ¹	1	1	1
Tender	1	1	2
Standby Diver Tender	1	1	1
TOTAL <u>MINIMUM</u> TEAM	5 or 6	5 or 6	8

Note:
For applicable staffing level notes, see table 30-8.

Table 30-7
Staffing Levels for Scientific Snorkeling: Untethered, 0 to 5 feet (0 to 1.5 m)

Personnel	Number
Team Supervisor ⁵	1
Snorkelers (in visual contact)	2
TOTAL <u>MINIMUM</u> TEAM	3

Note:
 For applicable staffing level notes, see table 30-8.

Table 30-8
Staffing Levels for Scientific Snorkeling: Tethered, Greater than 5 feet (1.5 m)

Personnel	Number
Team Supervisor ⁵	1
Snorkeler in water	1
Team Member ⁵	1
TOTAL <u>MINIMUM</u> TEAM	3

Staffing level notes (Tables 30-2 through 30-8):

- ¹ The standby diver must be rested and capable of performing emergency rescue assistance. When work is limited to no decompression limits, the standby diver must be sufficiently free of residual nitrogen to allow for 25 minutes of bottom time at the working depth without exceeding "No Decompression Limits."
- ² The trained chamber operator may be any non-diving member of the dive team when the chamber is only for emergency use when diving within the no-decompression limits. Saturation diving requires that a life support technician must serve as the chamber operator.
- ³ The supervisor may be the standby tender for dives under 100 feet (30.5 m).
- ⁴ The trained chamber operator may be any non-diving member of the dive team if all diving ceases during chamber decompression.
- ⁵ The team supervisor and team member must be capable of performing emergency rescue assistance.

30-10. Checklists and Forms.

Not Applicable.

Chapter 31 Tree Maintenance and Removal

31-1. References.

- a. ANSI/International Society of Arboriculture (ISA) Z133, American National Standard for Arboricultural Operations – Safety Requirements (<https://www.isa-arbor.com/store/shop>) (31-1.a)
- b. ANSI/SAIA A92.2, Vehicle-Mounted Elevating and Rotating Aerial Devices (<https://shop.saiaonline.org>) (31-1.b)
- c. ANSI/Tree Care Industry Association (TCIA) A300, American National Standard for Tree Care Operations – Tree, Shrub, and Other Woody Plant Management – Standard Practices (https://www.tcia.org/TCIA/SHOP/Shop_Products/TCIA/Shop/Shop_Products.aspx?hkey=bf11ffce-3697-4665-9760-9f2d37127c9c) (31-1.c)
- d. 29 CFR 1910.266, Logging Operations (<https://www.govinfo.gov/content/pkg/CFR-2022-title29-vol5/pdf/CFR-2022-title29-vol5-sec1910-266.pdf>) (31-1.a)
- e. 29 CFR 1910.269, Electric Power Generation, Transmission, and Distribution (<https://www.govinfo.gov/content/pkg/CFR-2022-title29-vol5/pdf/CFR-2022-title29-vol5-sec1910-269.pdf>) (31-1.e)

31-2. Definitions.

- a. **Arborist.** A professional in the practice of arboriculture, which is the cultivation, management, and study of individual trees, shrubs, vines, and other perennial plants. Arborists generally focus on the health and safety of individual plants and trees. Arborists typically climb trees using ropes and have special training in this type of climbing. (31-2.a)
- b. Barber Chair. A circumstance where a tree trunk splits vertically while it is being cut down. (31-2.b)
- c. **Bucking.** The act of sawing a felled tree or limbs into smaller sections. (31-2.c)
- d. Conventional Notch. A directional felling notch cut into the tree on the same side that the tree is to fall. The notch starts with a horizontal cut approximately one third the tree's diameter. The second cut is sawed at a 45-degree angle from a height of 2.5 inches (6.4 cm) per 1 foot (0.3 m) of diameter above the base of the notch. (31-2.d)

e. False Crotch. A pulley, block, sling, lashing, or metal ring affixed to a tree's leader or limb, through which a load line is passed to raise or lower limbs or equipment. (31-2.e)

f. Gaffs. Spurs used to assist in climbing utility poles or trees. (31-2.f)

g. Humboldt Notch. A directional felling notch cut into the side of a tree. The completed notch faces the intended direction of fall and consists of a horizontal face cut and an angled cut below it, creating a notch of approximately 45-degrees. A Humboldt notch is usually reserved for larger trees on steep slopes. (31-2.g)

h. Leader. The upper portion of the primary axis of a tree. (31-2.h)

i. Limbing. To cut limbs from a tree trunk. (31-2.i)

j. Open-Faced Notch. Two sequential cuts into the side of a tree that results in either a conventional notch or Humboldt notch. (31-2.j)

k. Qualified Line-Clearance Tree Trimmer. A tree worker who, through related training and on-the-job experience, is familiar with the line-clearance hazards and has demonstrated ability in the performance of the special techniques involved. (31-2.k)

l. Qualified Line-Clearance Tree Trimmer Trainee. Any worker undergoing line-clearance tree trimming training who, in the course of such training, is familiar with line-clearance hazards and has demonstrated ability in the performance of the special techniques involved. (31-2.l)

m. Qualified Tree Worker. An individual who, through related training and on-the-job experience, is familiar with the equipment, techniques, and hazards of tree maintenance and removal and has demonstrated ability in the performance of the special techniques involved. (31-2.m)

n. Tied In. When a tree climber's climbing line has been properly crotched and attached to the saddle and taut-line hitch is tied. (31-2.n)

31-3. Personnel Required Qualification/Training.

a. Employees must be instructed in the safe and proper use of all equipment provided to them according to the manufacturer's instructions. (31-3.a)

b. Tree climbers must be medically cleared for unlimited tree climbing every two years by a Health Care Provider (see chapter 3). The examination must identify predisposing factors and mitigation measures for prior heat/cold injuries, address the ability to work on uneven surfaces at heights, and identify any allergies to expected environmental allergens. Additionally, it must address medical conditions and the use of medications that could affect balance, the ability to communicate with others, level of

consciousness, extremity sensation, fine motor movement, and gross motor movement, and the ability to physically lift or lower oneself. (31-3.b)

c. Qualified line-clearance tree trimmers must be trained and qualified by the employer according to 29 CFR 1910.269. (31-3.c)

d. Employees using brush chippers must be trained according to the manufacturer's instructions to include safe operation procedures. (31-3.d)

e. The services of other licensed or credentialed professionals may be necessary to properly address the required maintenance to be performed and/or hazards that may be encountered. Examples of credentialed professionals include but are not limited to: Certified Arborist, Licensed Tree Expert, Certified Tree Care Safety Professional, Certified Crane Operator, Rigger, or Certified Utility Safety Professional. (31-3.e)

f. Employers of workers using chainsaws, see paragraph 13-3.c. (31-3.f)

31-4. Roles and Responsibilities. Qualified Tree Worker.

a. Develop a Tree Maintenance and Removal Plan according to paragraph 31-7. (31-4.a)

b. Conduct inspections according to paragraph 31-5. (31-4.b)

c. Identify and verify all safety precautions have been met prior to commencement of work. (31-4.c)

31-5. Inspection Requirements.

a. Test electrically rated aerial devices with approved test methods and equipment according to ANSI/SAIA A92.2, annually. (31-5.a)

b. Inspect, maintain, repair, and use equipment according to the manufacturers' instructions. (31-5.b)

c. Prior to beginning tree maintenance and/or removal activities, a Qualified Tree Worker must inspect the tree and surrounding areas to include the following: (31-5.c)

(1) Tree hazards, including the following:

(a) Tree hangers.

(b) Broken, loose., or dead branches or tops.

(c) Entanglement with adjacent or downed trees.

- (d) Shape and lean of the tree.
- (e) Tree damage from wind, lightning, or disease.
- (f) Vines or interlocking limbs.
- (g) Species of the tree, bees, or other wildlife habitation
- (h) Root mass stability.
- (i) Ice or snow load.
- (j) Throw-back or bounce-back potential.
- (k) Lodged trees or dead snags.
- (l) Barber chair potential.
- (m) Foreign objects (for example, nails, wire fence, concrete).

(2) Location of obstacles and adjacent structures, including septic lines, tanks, and other potential at-grade or below grade utilities that could be impacted.

(3) Environmental hazards, including weather conditions (for example, wind force and direction), poisonous plants, water.

(4) Overhead hazards, including electrical lines, conductors, or other wires.

(5) Potential for flying debris from tree impact.

31-6. Activity Hazard Analysis (AHA) Requirements.

Develop AHAs according to paragraphs 1-6 or 2-6, as applicable.

31-7. Minimum Plan Requirements.

Tree Maintenance and Removal Plan. A Tree Maintenance and Removal Plan is required when tree maintenance and/or removal activities are performed. The plan must be developed by and under the direction of a Qualified Tree Worker and include the following. Submit plans to the USACE supervisor for approval or to the KO or COR for acceptance prior to performing work.

a. Detailed description of the activity being performed, including the tools, resources, and PPE required. (31-7.a)

(1) For tree felling/removal, include the identification of tree sizes, selected direction of fall, and landing zone.

(2) For tree climbing, identify climbing techniques and equipment to be used.

b. Description of anticipated hazards or concerns, include size and terrain characteristics or limitations of the work area. (31-7.b)

c. Assignment of personnel and their roles and responsibilities. Include necessary information to support qualification/training of such persons. (See para 31-3) (31-7.c)

d. Identification of a retreat path. (31-7.d)

e. Access control to the work site. (31-7.e)

f. Inspection and oversight methods to ensure adherence to the plan. (31-7.f)

31-8. General Requirements.

a. Personal Protective Equipment (PPE). PPE, as outlined in this chapter, is required when there is a reasonable probability of injury or illness that can be prevented by such protection. (31-8.a)

(1) Wear a hardhat and eye protection during all tree maintenance and removal operations.

(2) Additional PPE for chainsaw use includes protective leg chaps made of cut-resistant material, safety boots, and hearing protection.

(3) When flush cutting stumps with a chainsaw, everyone assisting the chainsaw operator must wear the same level of PPE that is required of the chainsaw operator.

(4) Refer to chapter 5 for additional PPE requirements.

b. Working Near Electrical Equipment and Systems. Before tree maintenance or removal activities begin, a Qualified Tree worker must make visual inspection to determine whether any electrical hazards exist. (31-8.b)

(1) Employees must consider all electrical equipment or conductors in the proximity of the work to be energized. If electrical lines or equipment cannot be safely avoided, make arrangements with the power company to mitigate the electrical hazard. Mitigation options should include the power company de-energizing, testing, isolating, and grounding the electrical conductors as well as following all OSHA-compliant and practical work methods. The Qualified Tree Worker and designated power company representative must confirm that protective ground(s) have been installed as close to the work to be performed to prevent hazardous differences in electric potential.

(2) When electrical equipment and conductors cannot be de-energized, only a Qualified Line-Clearance Tree Trimmer or Line-Clearance Trainee under the direct supervision of a Qualified Person, Electrical may be assigned to work in close proximity to electrical hazards. See chapter 11 and 29 CFR 1910.269 for additional electrical safety requirements.

(3) A second Qualified Line-Clearance Tree Trimmer/Trainee must be aloft and within normal voice communication range during the clearing operations whenever the following conditions exist:

(a) When the Qualified Line-Clearance Tree Trimmer/Trainee must approach any closer than 10 feet (3 m) to any conductor or electrical apparatus energized in excess of 750 volts.

(b) When branches or limbs being removed cannot first be cut (with a pole pruner or pole saw) sufficiently clear of the equipment or conductors so as to avoid contact.

(c) When roping is required to remove branches or limbs from electrical equipment or conductors.

(4) Qualified Line-Clearance Tree Trimmers/Trainees must maintain the distances from energized conductors according to table 11-3. All other tree workers must maintain a minimum separation distance of 10 feet (3 m) or greater according to table 11-4.

(5) Aerial devices that are electrically rated above the electrical voltages of adjacent power lines are exempt from the 10 feet (3 m) rule and can follow table 11-3 if operators, in addition to being Qualified Line-Clearance Tree Trimmers/Trainees, have been electrically qualified (see chapter 11). Inform operators that insulated aerial devices do not protect them from other potentially fatal electric paths to the ground, such as paths through trees, guy wires, or from phase-to-phase contact.

c. Tools. (31-8.c)

(1) Use tool handles when raising and lowering tools.

(2) Carry tools used for cabling, bark tracing, cavity work, etc. in a bag, belt, or sheath designed to hold tools. Do not put tools in clothing pockets or stick in the top of a boot.

d. Elevating Aerial Work Platforms (AWPs). Provide AWP with fall protection anchor(s) meeting design requirements of ANSI/SAIA A92.2 to secure approved personal fall protection system(s) (for example, full body harness with an energy-absorbing lanyard). All occupants of the AWP must utilize personal fall protection systems whenever aloft. (31-8.d)

(1) The AWP occupants may use a climber's belt and lanyard in place of a full body harness to transfer from the AWP to the tree. The employee must be secured to the tree prior to removing the lanyard attached to the basket. Do not perform any work while secured to both the tree and the basket.

(2) Refer to chapter 21 for additional fall protection requirements.

e. Tree Climbing. (31-8.e)

(1) When tree climbing is performed, persons must not work alone. A secondary climber, who could assist in rescue, if necessary, must be immediately available.

(2) Tree Climbing Techniques. Climbers may apply a variety of climbing techniques. Identify climbing techniques to be used in the Tree Maintenance and Removal Plan according to paragraph 31-7.

(3) Do not use rope access unless other means of accessing the tree or undertaking the work, such as aerial devices or pole saws, are not practical. See chapter 23 for rope access requirements.

(4) Climbers must not ascend above their tie-in point. Locate tie-in points well above the climber to prevent an uncontrolled pendulum swing in the event of a slip.

(5) Climbers must tie-off at two points while working or using a chainsaw. This includes attaching the primary support with the access line or climbing line and the secondary support with a second climbing line or the flip line/lanyard/buck strap.

(a) Climbers may ascend or descend solely by the access line by using approved single rope techniques.

(b) Once the climber is at the tie-in point, they must install a secure climbing system.

(c) The climber must establish a new tie-in point before disconnecting from the access line.

(6) Use of the three-point contact climbing is recommended, if possible. Climbers may use ground personnel to help them up the tree.

(7) Climbers must have a climbing line and at least one other means of being secured on their person at all times (for example, climbing line and a work positioning lanyard).

(a) Climbers must be tied in with an approved type of climbing line and safety saddle while ascending the tree, including when using climbing spurs or gaffs.

(b) Climbers must be tied in once the work begins and remain tied in until the work is completed and they have returned to the ground.

(c) Climber must be secured when repositioning the climbing line.

(d) Climbers may not perform work while standing on a ladder unless they are properly tied in or secured.

(e) Safety, secondary, belay or back-up line(s) must not be used alone for tree climbing. The use of a secondary line (safety line) may pose additional risks and increased difficulties. Careful consideration to the impact of secondary line use should be considered before making a decision on use in tree climbing operations.

(8) To prevent any binding of the safety line, locate the climbing line as high above the ground as possible and pass it around the trunk of the tree using branches with a wide crotch. The selected crotch should be located as close as possible to directly above the work area and in such a way that a slip or fall would swing the climber away from any electrical conductor. Pass the line around the main leader or an upright branch, using the limb as a stop. Keep feet, hands, and ropes out of tight V-shaped crotches.

Note. Exception: Palms and other trees with similar growth characteristics that will not allow a climbing line to move freely.

(9) Climbers must tie a stopper knot (for example, figure-eight knot) in the end of the line to prevent accidentally pulling the climbing line through the climbing hitch and possibly falling. The stopper knot is critical when climbers work at heights greater than half the length of the climbing line.

(10) If it is necessary to re-crotch the climbing line in the tree, the climbers must re-tie in or use the safety strap before releasing the previous tie.

(11) Climbers working from a stem or spar without a suitable natural crotch must select tie-in points or a tie-in method that positively prevents the climbing line from sliding down, up, or off the stem.

(12) Do not place a climbing line around a stem in an area without a lateral limb unless the climbing line is cinched or choked around the stem or runs through a double-wrapped or adjustable false crotch that is also secured or cinched around the stem.

(13) The selected tie-in point must be able to withstand the forces being applied during pruning and removal operations.

(14) Climbers must not carry tools in their hands while climbing, except during topping or removing operations. Use a line to raise and lower chainsaws and tools one at a time.

(15) Climbers must carry a hand saw. When carried aloft, secure the hand saw in a scabbard attached to the climbing saddle.

(16) Do not climb dead or dying trees unless there are no safer and more feasible alternatives to removing the trees. Do not use dead branches to support weight. If possible, break off dead branches on the way up while placing hands and feet on separate limbs.

(17) Do not climb live trees with spurs when pruning or otherwise maintaining them unless done according to ANSI/TCIA A300 tree care management standards.

(18) Gaff lengths must be suitable for the tree being climbed. For thick bark trees use spurs with longer gaffs, such as 2¾ inches (7 cm). Gaff lengths of 1¾ inches (4.4 cm) are intended only for pole climbing.

(19) Whenever possible, remove debris and other objects from beneath the climber.

f. Felling. (31-8.f)

(1) Prior to felling operations, clear the work area to permit safe working conditions and plan an escape route. Ensure that homes and structures are evacuated where trimming and felling operations are in close proximity.

(2) Establish felling paths that are at least twice as long as the height of the tree to account for limbs and debris being thrown after hitting the ground. Where this distance cannot be secured or maintained, limbing may be required. Drop or deenergize power lines when necessary.

(3) Instruct workers on the exact tasks to be performed. Workers not directly involved in the operation must keep clear of the work area.

(4) Before starting to cut, the chainsaw operators must secure their footing and clear away brush, fallen trees and other materials that might interfere with cutting operations.

(5) When felling trees over 5 inches (12.7 cm) in diameter (measured at breast height), use a notch and back cut. Do not fell trees with “slicing” or “ripping” cuts.

(a) Do not cut through the apex (that is, the point where two cuts that form the notch meet).

(b) Use only a conventional notch, an open-face notch, or a Humboldt notch.

(c) Notches must be 45-degrees or greater for conventional and Humboldt notches, 70-degrees or greater for open-face notches and large enough to guide the fall of the tree or trunk.

(d) Notch depth should not exceed one-third the diameter of the tree.

(e) The hinge width should be 80 percent of the tree's diameter, as measured at the hinge.

(f) When saw cuts are made to form the notch and back cut, leave suitable amounts of hinge wood to adequately control the directional fall of the tree.

(g) With a conventional notch or Humboldt notch, the back cut must be 1 to 2 inches (2.5 to 5.1 cm) above the apex of the notch to provide an adequate platform to prevent kickback of the tree or trunk. With an open-face notch, the back cut should be at the same level as the apex of the notch.

(6) If sections of the tree are to be removed, limit section lengths to one-third the distance to the nearest structure (for example, if the tree is 30 feet (9.1 m) from the structure, sections must be no more than 10 feet (3 m) long).

Note. The chainsaw operators must use discretion. In some instances, it will be safer to fell a large trunk away from the structure rather than to remove it in small sections, especially where the tree has grown very close to the structure. Use a tag line and the appropriately placed notch and back cut to guide the direction of the fall.

(7) The chainsaw operator must work from the uphill side whenever possible. When tag lines are used to help guide the direction of the fall, the workers on the tag line must be well clear of the fall path, at least twice the distance of the fall area.

(8) Just before the tree or limb is ready to fall, give an audible warning to all those in the area. All persons must be safely out of range when the tree falls.

(9) If there is danger that a tree may fall in the wrong direction or damage property, use wedges, block and tackle, rope, or wire cable (except when an electrical hazard exists). Remove all limbs from trees to a height and width sufficient to allow the tree to fall clear of any wires and other objects in the vicinity.

(10) Take special precautions when roping rotten or split trees due to the potential for falling in an unexpected direction even when the cut is made on the proper side.

(11) Workers must move away and keep back from the butt of a tree that is starting to fall.

g. Brush Removal and Chipping. (31-8.g)

(1) Keep sites clear of brush and logs so no hazards are created at the work site.

(2) Brush Chippers.

(a) Operate and maintain brush chippers according to the manufacturer's instructions. All employees using brush chippers must be trained according to paragraph 31-3.

(b) Where rotary drum and disk-type tree or brush chippers are not equipped with a mechanical infeed system, install an in-feed hopper not less than 85 inches (216 cm) long and a flexible anti-kickback device on the in-feed hopper. These additional devices will protect the operator and other persons in the machine area from the hazards of flying chips and debris. The length for the in feed-hopper is the sum of the horizontal distance from the chipper blade out along the center of the chute to the end of the chute plus the vertical distance from the chute down to the ground.

(c) Where disk-type tree or brush chippers are equipped with a mechanical in-feed system, install a quick stop and reversing device on the in-feed. Locate the activating mechanism for the quick stop and reversing device across from the top, along each side of, and as close as possible to the feed end of the in-feed hopper and within easy reach of the operator.

(d) The feed chute or feed table of a chipper must have sufficient height on its side members to prevent operator contact with the blades or knives during normal operation.

(e) Brush chippers must be equipped with a discharge chute of sufficient length or design to prevent contact with the blade.

(f) Brush chippers must be equipped with a locking device on the ignition system to prevent unauthorized starting of the equipment.

(g) Keep brush chipper cutting bars and blades sharp, properly adjusted, and otherwise maintained according to the manufacturer's recommendations.

(h) Chock or otherwise secure trailer brush chippers detached from trucks.

(i) All workers feeding brush into chippers must wear eye protection. Workers must not wear loose clothing, gauntlet-type gloves, rings, or watches.

(j) Never place hands, arms, feet, legs, or any other part of the body on the feed table when the chipper is in operation or the rotor is turning. Use push-sticks that can be consumed by the brush chipper or long branches to feed material into the chipper.

(k) Feed brush chippers from the side of the centerline. The operator must immediately turn away from the feed table when the brush is taken into the rotor. On roadways, feed chippers from the curbside whenever possible.

(l) Do not feed material such as stones, nails, sweepings, etc. into brush chippers.

(m) Do not raise or remove the brush chipper discharge chute or cutter housing cover while any part of the chipper is turning or moving.

h. Other Operations and Equipment. (31-8.h)

(1) Pruning and Trimming.

(a) Pole pruners, pole saws, and similar tools must have wood or nonmetallic poles. Actuating cords must be of a non-conducting material.

(b) Before limbs are dropped, give an audible warning.

(c) Attach a separate lowering or rigging line to limbs that cannot be safely dropped or are too heavy to be controlled by hand. Control the lowering or rigging line from the ground unless safer from up the tree. Avoid using the same crotch for both the climbing line and the lowering or rigging line.

(d) Do not use ropes/climbing lines to lower limbs or other parts of trees or to raise or lower equipment, with the exception of hand tools.

(e) When handling limb removal ropes, ground personnel must not wrap the rope around their hands or waist and keep the rope away from their feet to prevent entanglement.

(f) Do not leave cut branches overnight in trees.

(g) Install a service line for operations lasting overnight. Use the service line to bring the climbing line back into position at the start of the next day's work.

(h) When not in use, carry each handsaw in a scabbard or sheath that is hooked to the climbing belt.

(i) When not in use, securely hang pole pruners and pole saws in a vertical position with the sharp edges away from employees. Do not hang on utility wires or cables or leave overnight in trees.

(2) Limbing and Bucking.

(a) When more than one worker is limbing or bucking the same tree, organize the tasks and position them so that the actions of one worker will not create a hazard for any other worker.

(b) Consider all branches bent under tension as hazardous.

(c) Operate chainsaws with the bar outside of the legs and never make cuts between the legs. Whenever possible, keep the tree limb or similar barrier between yourself and the saw blade, while ensuring proper balance. The preferred working position is from the uphill side of the work on the opposite side of the tree trunk.

(d) Block the trunk or logs to prevent rolling, when necessary. Before bucking or limbing wind-thrown trees, take precautions to prevent the root ball or butt log from striking a worker.

(e) When bucking, use wedges, as necessary, to prevent binding of the guide bar or chain.

(f) Workers must have stable footing and stand in a balanced position that allows freedom of movement before and during limbing and bucking. Do not stand on loose chunks or logs that could roll when a cut is completed.

(3) Stump Removal. Equip stump cutters with enclosures or guards that effectively protect the operator.

(4) Cabling.

(a) Bring branches together to the desired distance by means of a block and tackle, a hand winch, a rope, or a rope with a come-along.

(b) No more than two persons may be in a tree when installing cables.

(c) If an old cable system is being replaced, the old system must not be removed until after the new system is installed.

(d) When the block and tackle is released, workers in trees must position themselves off to one side in order to avoid injury in case the lag hooks pull out under the strain.

(e) Ground persons must not stand under the tree when cable is being installed.

(5) Topping/Lowering Limbs.

(a) When topping a tree, determine whether the tree and individual branches can support the strain of the topping procedures. If the stresses are too great, then use some other means to lower the branches.

(b) If large limbs are lowered in sections, the worker in the tree must be above the limb being lowered.

(6) Trucks.

(a) Provide a steel bulkhead (or equivalent) to protect the occupants of vehicles from load shifts.

(b) Logs or brush must be securely loaded onto trucks to ensure the running, brake, and head lights are not obscured, the driver has a full view out the windshield and side windows, and the load does not overhang the sides.

(c) Do not store wood chips in trucks or trailers for extended periods to avoid spontaneous combustion or the production of undesirable byproducts from piled wood chips.

(7) Power Saws.

(a) Secure chainsaws from falling. Climbers may attach chainsaws weighing less than 15 lbs. (6.8 kg) to themselves by means of a saw lanyard. When more than 15 lbs. (6.8 kg), support by a separate line crotched in the tree. Use a false crotch where there are no lateral branches on which to crotch a separate support line.

(b) Do not use corded electrical power saws or other corded electric tools in the vicinity of overhead power lines. Hydraulic or electric power saws may be used.

(c) Do not run chainsaws while ascending, descending, or moving any considerable lateral distance in the tree.

(d) Refer to chapter 13 for additional chainsaw requirements.

(8) Chopping Tools.

(a) Do not use chopping tools that have loose or cracked heads or splintered handles.

(b) Never use chopping tools while working aloft.

(c) Swing chopping tools away from the feet, legs, and body, using the minimum power practical for control.

- (d) Do not use chopping tools as wedges or to drive metal wedges.
- (e) Properly sheath all edged tools and blades when not in use.
- (9) Cant Hooks, Tongs, and Carrying Bars.
 - (a) Firmly set hooks before applying pressure.
 - (b) Before moving logs, warn those in the area and ensure that everyone is clear.
 - (c) Hook points must be at least 2 inches (5.1 cm) long and kept sharp.
 - (d) When rolling logs, stand to the rear and uphill.
- (10) Wedges and Chisels.
 - (a) Wedges and chisels must be properly pointed and tempered.
 - (b) Use only wood, plastic, or soft metal wedges with power saws.
 - (c) Protect all wood-handled chisels with a ferrule on the striking end.

31-9. Figures and Tables.

Not Applicable.

31-10. Checklists and Forms.

Not Applicable.

Chapter 32
Airfield and Aircraft Operations

32-1. References.

- a. FAA AC 150/5210-20A, Ground Vehicle Operations to include Taxiing or Towing an Aircraft on Airports
(https://www.faa.gov/regulations_policies/advisory_circulars) (32-1.a)
- b. FAA AC 150/5370-2F, Operational Safety on Airports During Construction
(https://www.faa.gov/regulations_policies/advisory_circulars) (32-1.b)
- c. FAA AC 150/5370-2G, Operational Safety on Airports During Construction
(https://www.faa.gov/regulations_policies/advisory_circulars) (32-1.c)
- d. UFC 3-260-01 Airfield and Heliport Planning and Design
(<https://www.wbdg.org/ffc/dod/unified-facilities-criteria-ufc>) (32-1.d)

32-2. Definitions.

a. Approach-Departure Clearance Surface. An extension of the primary surface and the clear zone at each end of the runway, first along an inclined plane (glide angle) and then along a horizontal plane, both flaring symmetrically about the runway centerline extended. (32-2.a)

b. Foreign Object Debris (FOD). Stones and other small objects that might damage aircraft propellers or jet aircraft. (32-2.b)

32-3. Personnel Required Qualification/Training.

Provide training to vehicle drivers and equipment operators to ensure compliance with the airport operator's vehicle rules and regulations. Provide specific training to vehicle operators providing escorts according to FAA AC 150/5210-20A.

32-4. Roles and Responsibilities.

a. A Competent Person (CP). See paragraphs 1-2 or 2-2, as applicable. Must prepare a Construction Safety and Phasing Plan (CSPP) and Safety Plan Compliance Document (SPCD) according to paragraph 32-7. (32-4.a)

b. Airfield Managers will review and accept the CSPP and SPCD no later than 14 days prior to beginning work. (32-4.b)

32-5. Inspection Requirements. Not Applicable.

32-6. Activity Hazard Analysis (AHA) Requirements.

Develop AHAs according to paragraphs 1-6 or 2-6, as applicable, for all airfield operations. The AHA must include the work methods to be used to include systems, equipment, and other materials, tools, and PPE, along with the controls used to eliminate or control the hazards to an acceptable level.

32-7. Minimum Plan Requirements.

CSPP and SPCD. The USACE supervisor/KO or COR will ensure the airfield's appropriate FAA Regional or District Office is notified of the construction and will provide the FAA a copy of the CSPP and SPCD. Before changes to the approved/accepted CSPP or SPCD may be implemented, the USACE supervisor/KO or COR and Airfield Manager must be informed in writing of proposed revisions to the approved CSPP and SPCD.

a. Construction Safety and Phasing Plan (CSPP). A CP must prepare the CSPP according to FAA 150/5370-2F and UFC 3-260-01 following the format identified in FAA 150/5370-2F. (32-7.a)

b. Safety Plan Compliance Document (SPCD). A CP must prepare the SPCD according to FAA 150/5370-2G and UFC 3-260-01 following the format identified in FAA 150/5370-2G. (32-7.b)

32-8. General Requirements.

a. General. (32-8.a)

(1) Airports and airfields are complex environments and procedures and conditions associated with construction activities often affect aircraft operations and can jeopardize operational safety. Safety considerations are paramount and may make operational impacts unavoidable. However, careful planning, scheduling, and coordination of construction activities can minimize disruption of normal aircraft operations and avoid situations that compromise the airport's operational safety. The Airfield Manager must understand how construction activities and aircraft operations affect one another. This understanding is critical to develop an effective plan to complete the work. Only after allowing a determination if the proposed construction or other work would have a hazardous effect on air navigation, the plan would identify the need for obstruction marking and lighting, or other measures necessary to ensure safe airspace. Prior to work, various coordination activities, (for example, communicate with Airfield Manager, file FAA Form 7460-1 (Notice of Proposed Construction or Alternation) see para 32-10, file Notice to Air Mission (NOTAM), DoD notifications) must be conducted.

(2) The following safety requirements are in addition to the airfield's day to day operational safety requirements. When an airfield has safety requirements that differ from those of this chapter, the more stringent requirements apply.

(3) Unless the Airfield Operator closes a runway and properly marks it, it may not be used for purposes other than aircraft operations unless approved by the USACE supervisor or accepted by the KO or COR.

(4) Keep all paved surfaces, such as runways, taxiways, and hardstands clean at all times, particularly with regards to FOD. Perform sweeping operations by truck mounted vacuum sweeper capable of regenerative air sweeping and water to minimize dust generation. When possible, magnetic bar assemblies should be attached to vehicles and used to pick up ferrous metal FOD.

(5) When mobile equipment is not actively being utilized to perform work on an airfield, remove it to an approved location away from the runway centerline and outside the Runway Safety Area (RSA), the Obstacle Free Zone, and the Runway Object Free Area of active runways as approved by the USACE supervisor or accepted by the KO or COR.

(6) Do not place anything upon the landing areas without approval by the USACE supervisor or accepted by the KO or COR approval.

(7) All vehicle access must be at an entry control point and approved by the Airfield Manager. Maintain effective control of vehicles required to enter or cross aircraft movement areas.

(8) When work is to be performed at an airfield where flying is controlled, obtain permission to enter a landing area from the control tower operator every time entry is required, unless the landing area has been closed by the Airfield Operator and marked as hazardous.

(9) When working in landing areas, perform work so as to leave that portion of the landing area that is available to aircraft free from hazards, including holes, piles, or material, and projecting shoulders that might damage an airplane tire. Equip each vehicle, piece of equipment, or work crew with a two-way radio capable of keeping communications with the air traffic control (ATC) tower while performing work in landing areas.

(10) Do not place equipment, materials, or contractor plant upon or within a safety precaution area without approval of the USACE supervisor or acceptance by the KO or COR.

(11) If an object in a safety precaution area projects above the approach-departure clearance surface or above the transitional surface, the object must be marked with a red light.

b. Excavations. (32-8.b)

(1) Open trenches or excavations are not permitted within the RSA while the runway is open or on the Taxiway Surface Area while the taxiway is open. If possible, backfill trenches before the runway or taxiway is opened. If the runway or taxiway must be opened before excavations are backfilled, cover the excavations appropriately. Covering for open trenches must be designed to allow the safe operation of the heaviest aircraft operating on the runway across the trench without damage to the aircraft.

(2) Mark open trenches and excavations at the construction site with red or orange flags and red lights, as approved by the Airport Operator, and light them with red lights during hours of restricted visibility or darkness.

(3) Lights must be red, either steady burning or flashing, and must meet the luminance requirements of the State Highway Department. Lights must be mounted on barricades and spaced at no more than 10 feet (3 m). Operate the lights between sunset and sunrise and during periods of low visibility whenever the airport is open for operations. They may be controlled by photocell, but this may require that the contractor turn them on manually during periods of low visibility during daytime hours.

c. Vehicle Requirements. (32-8.c)

(1) Provide all vehicles with a flag on a staff attached to the vehicle so that the flag will be readily visible if the vehicles do not routinely traverse any portion of the air operations area (AOA) under the control of ATC and if they are not escorted by a vehicle in constant two-way radio communication with ATC and properly equipped and authorized to operate in the AOA.

(2) Provide flags on all vehicles at airports that do not have ATC facilities.

(3) Each flag must be at least a 3 feet by 3 feet (0.9 m by 0.9 m) square having a checkered pattern of international orange and white squares at least 1 feet (0.3 m) on each side.

d. Notice to Air Mission (NOTAM) (32-8.d)

(1) Submit information on landing areas hazards to aircraft to the Airfield Manager. Unless otherwise directed by the USACE supervisor/KO or COR, the Airfield Manager will prepare an FAA NOTAM for the hazards associated with the displaced threshold or other changes on non-use or caution. Those landing areas hazardous to aircraft must be submitted to the Airfield Manager for a FAA NOTAM on displaced threshold or other changes on non-use or caution unless otherwise directed by the USACE supervisor/KO or COR.

(2) During daylight, outline the areas with highly reflective barricades, lights, signs, and/or orange or red flags, spaced according to FAA AC 150/5370-2G and as approved by the Airfield Manager. The flags must be at least 20 inch x 20 inch (51 cm x 51 cm), with diagonal plastic stiffeners.

(3) During periods of darkness, outline the areas with battery-operated, low-intensity omni-directional red flashing lights spaced according to FAA AC 150/5370-2G and as approved by the Airfield Manager.

(4) Lights must be red, either steady burning or flashing, and must meet the luminance requirements of the State Highway Department. Mount the lights on barricades and space them no more than 10 feet (3 m) apart. Operate the lights between sunset and sunrise and during periods of low visibility whenever the airport is open for operations. They may be controlled by photocell, but this may require that the contractor turn them on manually during periods of low visibility during daytime hours.

(5) The USACE supervisor/KO or COR must keep the Airport Operator informed so that a NOTAM can be issued to reflect hazardous conditions or changes to the CSPP.

e. Notice of Proposed Construction or Alternation. Construction of new airfields, heliports, helipad or hoverpoints, or modifications to existing facilities affecting the use

of airspace or changes in aircraft densities may require notification to the FAA Administrator. Promptly submit a notice of proposed construction or alternation (for example, FAA Form 7460-1 (Notice of Proposed Construction or Alternation) see para 32-10) to have the FAA conduct an aeronautical study of potential obstructions such as tall equipment (for example, cranes, concrete pumps), stockpiles, and haul routes. One form may be filed describing the entire construction area and maximum equipment height or a separate form can be filed for each potential obstruction. In the former case, a separate form must be filed for any object beyond or higher than the originally evaluated obstruction. (32-8.e)

f. Prohibitions. (32-8.f)

(1) Do not use tall equipment (for example, cranes, concrete pumps) unless an FAA Form 7460-1 (Notice of Proposed Construction or Alternation) (see para 32-10) response determination letter is issued by the FAA for such equipment.

(2) Do not use open-flame welding or torches unless fire safety precautions are provided, and the Airport Operator has approved their use.

(3) Do not use electrical blasting caps on or within 1,000 feet (305 m) of the airport property.

(4) Do not use flare pots within the AOA.

32-9. Figures and Tables.

Not Applicable.

32-10. Checklists and Forms.

FAA Form 7460-1, Notice of Proposed Construction or Alternation
(<https://www.faa.gov/forms>)

Chapter 33

Uncrewed Aircraft

33-1. References.

a. AR 95-1, Flight Regulations
(<https://armypubs.army.mil/ProductMaps/PubForm/AR.aspx>) (33-1.a)

b. AR 95-20, Contractor Flights and Ground Operations
(<https://armypubs.army.mil/ProductMaps/PubForm/AR.aspx>) (33-1.b)

c. AR 385-10, Army Safety Program
(<https://armypubs.army.mil/ProductMaps/PubForm/AR.aspx>) (33-1.c)

- d. FAA Advisory Circular (AC) 2G: 5370-2G, Operational Safety on Airports During Construction
(https://www.faa.gov/airports/resources/advisory_circulars/index.cfm/go/document.current/documentNumber/150_5370-2) (33-1.d)
- e. FAA, FAA-H-8083-2, Risk Management Handbook
(<https://www.faasafety.gov/files/gslac/courses/content/62/740/FAA-H-8083-2.pdf>) (33-1.e)
- f. FAR Clause 42.302(a)(56), Maintain Surveillance of Flight Operations
(<https://www.govinfo.gov/content/pkg/CFR-1996-title48-vol1/pdf/CFR-1996-title48-vol1-sec42-302.pdf>) (33-1.f)
- g. National Defense Authorization Act (NDAA) 848 FY2020
(<https://www.congress.gov/116/crpt/hrpt333/CRPT-116hrpt333.pdf>) (33-1.g)
- h. USACE HQ Aviation Policy Letter (APL) 95-1-1, USACE Aviation Policies and Standards (<https://usace.dps.mil/sites/KMP-UAS>) (33-1.h)
- i. USACE Management Information System for Aviation & Remote Systems (MARS) (<https://uas.sec.usace.army.mil>) (33-1.i)
- j. 14 CFR 91, General Operating and Flight Rules
(<https://www.govinfo.gov/content/pkg/CFR-2020-title14-vol2/pdf/CFR-2020-title14-vol2-part91.pdf>) (33-1.j)
- k. 14 CFR 107, Small Unmanned Aircraft Systems
(<https://www.govinfo.gov/content/pkg/CFR-2020-title14-vol2/pdf/CFR-2020-title14-vol2-part107.pdf>) (33-1.k)
- l. 36 CFR 327, Rules and Regulations Governing Public Use of Water Resource Development Projects Administered by the Chief of Engineers
(<https://www.govinfo.gov/content/pkg/CFR-2011-title36-vol3/pdf/CFR-2011-title36-vol3-part327.pdf>) (33-1.l)
- m. 49 USC 40102, Transportation
(<https://www.govinfo.gov/content/pkg/USCODE-2021-title49/pdf/USCODE-2021-title49-subtitleVII-partA-subparti-chap401-sec40102.pdf>) (33-1.m)
- n. 49 USC 40125, Qualifications for Public Aircraft Status
(<https://www.govinfo.gov/content/pkg/USCODE-2011-title49/pdf/USCODE-2011-title49-subtitleVII-partA-subparti-chap401-sec40125.pdf>) (33-1.n)

33-2. Definitions.

a. Aircrew Training Program Manager (ATPM). Individual designated in writing by the Commander/Director, with concurrence from the Aviation Program Manager (APM), who has delegated authority to implement and manage the Small Uncrewed Aircraft System (SUAS) program. (33-2.a)

b. Air Mission. An approved flight, or series of flights, for a clearly defined task, purpose, and end-state. (33-2.b)

c. Air Mission Approval Authority (AMAA). Individual approved by the APM and delegated authority by the Commander/Director to accept risk and approve missions. (33-2.c)

d. Aviation Program Manager (APM). Individual designated by the Assistant Secretary of the Army (Civil Works), and delegated the authority by the Commanding General, USACE, to implement and oversee the USACE Aviation Program. (33-2.d)

e. Certificate of Authorization (COA). An authorization issued by the Air Traffic Organization to a public operator for a specific uncrewed aircraft (UA) activity. (33-2.e)

f. Field Operating Activity (FOA). All USACE Divisions, Districts, Labs, and Centers, as well as any other operational activity. (33-2.f)

g. Government Flight Representative (GFR). (Required for Aircraft Flight and Ground Operations). A current or previously rated U.S. Military officer or previously rated Government civilian. GFRs are appointed to perform the Contract Administration Services function, FAR Clause 42.302(a)(56). (33-2.g)

h. Uncrewed Aircraft System (UAS) Groups. (33-2.h)

(1) Group 1 UAS. UAS typically less than 20 pounds in weight; normally operate below 1200 feet AGL) at speeds less than 250 knots.

(2) Group 2 UAS. UAS typically are in the 21 – 55-pound weight class; normally operate below 3500 feet AGL at speed less than 250 knots.

(3) Group 3 UAS. These UAS weigh more than 55 pounds, but less than 1320 pounds. They normally operate below 18,000 feet mean sea level at speeds less than 250 knots.

i. Management Information System for Aviation & Remote Systems (MARS). A management information database that tracks equipment and personnel and assists in mission planning, approval, tracking, and archiving. (33-2.i)

j. Mission Briefing Officer (MBO). MBOs interact with the mission crew to validate the flight plan, risk assessment, and risk mitigation measures for approval by the AMAA. (33-2.j)

k. Mission Coordinator (MC). MCs are the overall SUAS mission leader and operational authority. MCs are selected for their level of aviation proficiency, judgment, and communication skills. The Remote Pilot (RP) is automatically the MC unless otherwise directed. MC and RP duties may be performed simultaneously. A single MC must be designated for missions involving more than one crew. (33-2.k)

l. Remote Pilot (RP). The RP is responsible for safe mission execution and is the final authority for operating, servicing, and securing the UA. RP is the base qualification for crewmembers, MBOs, and AMAAs. (33-2.l)

m. Small Uncrewed Aircraft System (SUAS). Group 1 or 2 remotely piloted aircraft, the associated control unit, antennas, and ancillary equipment. The term SUAS applies when referring to the entire system. (33-2.m)

n. Trusted Agent (TA). TAs are selected by the ATPM and appointed in writing by the APM (see figure 22 in APL 95-1-1), to validate the contractor's SUAS fleet and periodically monitor flight operations for compliance with the cybersecurity rules outlined by DoD. (33-2.n)

o. Visual Observer (VO). VOs are fully integrated crewmembers who attend and participate in the crew brief and debrief. VOs maintain visual contact with the UA and communicate its proximity to hazards, other aircraft, direction of travel, and location. (33-2.o)

33-3. Personnel Required Qualification/Training.

a. SUAS Aircrew. Provide training to SUAS Aircrew Personnel to ensure compliance with FAA, Army, and USACE policy, rules, and regulations. (33-3.a)

b. USACE Remote Pilots (RP). RPs must complete the USACE SUAS Qualification Course, be appointed in writing, and be in possession of a USACE SUAS Operator's Certificate. RP is the base qualification for crewmembers, MBOs, and AMAAs. (33-3.b)

c. Contractor SUAS Operators. Contractors operating SUAS in support of USACE projects must comply with the training and medical standards of 14 CFR 107, have written authorization from the APM, adhere to TA oversight, and comply with AR 95-20 and APL 95-1-1. (33-3.c)

d. Mission Briefing Officers (MBO). MBOs must be graduates of the USACE SUAS Qualification Course and be appointed in writing by the FOA ATPM. MBOs are selected based on their aviation knowledge, experience, maturity, and judgment. (33-3.d)

e. Visual Observers (VO). RPs are automatically qualified to perform VO duties, but in rare circumstances when a second crewmember is not available, the RP may select an untrained individual by briefing the following topics: (33-3.e)

- (1) Identifying hazards to flight and communication.
- (2) Directional, steering, and flight path cues to avoid hazards.
- (3) Crew coordination.
- (4) Conducting two-way radio communications.
- (5) Emergency procedures.
- (6) Monitor system indications.
- (7) Medical requirements.

Note. Frequent utilization of untrained VOs requires an exception to policy approval from the APM.

Note. VOs are required for all USACE SUAS flights unless waived in writing by the APM.

f. Trusted Agents (TA). TA must be trained by an ATPM. Training must include the following: (33-3.f)

- (1) Cybersecurity protocols in APL 95-1-1, Section 7.
- (2) Information requirements for the contractor's flight request.
- (3) Flight, accident and near miss, and reporting requirements.

33-4. Roles and Responsibilities.

a. Aircrew Training Program Manager (ATPM). ATPMs are the Commander's/Director's designated representative required to manage the SUAS program, which includes overseeing and implementing the aircrew training program, maintaining individual flight records, and managing the SUAS fleet. The ATPM is the primary point of contact for the FOA's aviation operations per APL 95-1-1. (33-4.a)

b. Mission Coordinator (MC). MCs are selected for their level of aviation proficiency, judgment, and ability to effectively communicate with other crews and the customer. For a single crew, the RP is the MC unless otherwise directed. MC and RP duties may be performed simultaneously. A single MC must be designated for missions involving more than one crew. The MC is the final authority for SUAS operations. (33-4.b)

c. Mission Briefing Officer (MBO). MBOs review proposed SUAS missions and provide intermediate approval before it is reviewed and approved by the ATPM and AMAA. (33-4.c)

d. Remote Pilot (RP). RPs are responsible for the safe and legal conduct of UA missions for USACE. The RP is the final authority for operating, servicing, and securing the UA and its associated equipment according to APL 95-1-1. (33-4.d)

e. Visual Observer (VO). VOs are mandatory for all USACE SUAS flights. VOs are required to be knowledgeable on the platforms and briefed on mission details before missions are executed according to APL 95-1-1. VOs must maintain visual contact with the UA at all times and perform other duties as assigned by the RP. The VO accurately describes the UA's proximity to hazards and other aircraft, direction of travel, and aircraft location relative to the launch and recovery site. Effective crew coordination between the VO and RP is critical to prevent an unsafe condition from developing into an accident or near miss. The VO must also communicate with the airspace control authority, controlling entity, and/or MC, as directed by the RP. VOs must attend and participate in crew briefs and debriefs. (33-4.e)

f. Trusted Agent (TA). TAs must review and acknowledge the requirements in APL 95-1-1 prior to being designated. (33-4.f)

g. Government Flight Representative (GFR). GFRs designated for USACE contracts and Government civilians must be current or former Rated Military Officers and vetted by the APM prior to designation by the Approval Authority. GFRs must work closely with the Headquarters Aviation GFR to standardize surveillance activities. (33-4.g)

33-5. Inspection Requirements.

Not Applicable.

33-6. Activity Hazard Analysis (AHA) Requirements.

Develop AHAs according to paragraphs 1-6 or 2-6, as applicable. AHAs must also address:

a. Section 12 of APL 95-1-1. (33-6.a)

b. Environmental. The SUAS environmental limitations must be considered when operating unprotected from the elements such as heat, cold, rain, snow, and/or wind. (33-6.b)

33-7. Minimum Plan Requirements.

a. Mission Risks. Mission risks must be evaluated, documented, and approved in MARS or on a DD Form 2977 (Deliberate Risk Assessment Worksheet) (see para 33-10.a) and then re-evaluated prior to launch for each SUAS mission per APL 95-1-1. (33-7.a)

b. Infrastructure. All missions, regardless of location, require a documented terrain and critical infrastructure analysis of the surrounding area within a distance prescribed by HQ USACE (5 miles in MARS). (33-7.b)

c. Deliberate and Operational Risk Assessments. Small Uncrewed Aircraft Crewmembers (SUACs) must define, consider, and mitigate risk in all phases of flight. (33-7.c)

d. Airspace. Determine the airspace classification and associated requirements. See APL 95-1-1, figure 8, FAA Airspace Guidance for Small UAS Operators, for further guidance. (33-7.d)

e. Daily Risk Assessment Worksheets (RAW). Crewmembers must complete the RAW as close as possible to takeoff to assess the most current mission risk factors associated with that day's flight per approved mission plan and documented MARS. (33-7.e)

Note. If the Risk Assessment Value on the RAW is higher than the projected level then the mission is cancelled until crewmembers receive written approval from the AMAA to fly. Text messages are an authorized means of written mission approval.

f. Pre-Accident Plan. USACE Aviation Pre-Accident Plans must be developed. Incorporate the plans into the Aircrew Reading File according to APL 95-1-1. (33-7.f)

33-8. General Requirements.

a. Coordinate all SUAS operations through the USACE HQ Aviation Program Office and follow APL 95-1-1 requirements. (33-8.a)

b. Authorizations. (33-8.b)

(1) SUAS crewmembers must coordinate with the airport/airfield manager before flying near an airport/airfield with an operational control tower.

(2) Airspace authorization is needed for controlled airspace (that is, Class B, C, D, E). Authorization must be coordinated through USACE HQ Aviation and granted by a COA from the FAA. Class B, C, D, and E airspace are controlled airspace needing additional authorization and clearance to access.

(3) Coordinate flights within restricted areas on DoD lands through the installation's Range Control activity.

c. Prohibitions. (33-8.c)

(1) Only c-compliant aircraft and Defense Innovation Unit Blue Cleared-List aircraft with an Authorization to Operate are authorized to fly with an approved mission packet.

(2) USACE employees and contractors supporting USACE projects are prohibited from purposefully collecting information, personal data, or images of private citizens that is outside of the mission parameters (see APL 95-1-1, section 11).

(3) Prolonged or hovering flight over people is not permitted. Transient flight (that is, traffic patterns) is acceptable (see APL 95-1-1).

d. Contractor Missions. (33-8.d)

(1) FOAs must work closely with USACE HQ Aviation for all new aviation contracts to determine its status as a Public or Civil Aircraft Operation (CAO).

(2) A Public Aircraft Operation (PAO) is a flight activity which meets the qualifications for public aircraft status in 49 USC 40125. All crewed and uncrewed aviation contracts for inherently governmental functions using Government owned aircraft, or contractor owned aircraft under purview of the Army Airworthiness Authority, must be examined by HQ USACE Aviation to determine the appropriate level of surveillance according to AR 95-20.

(3) Federal, DoD, and Army Regulations require USACE to maintain surveillance of contractor-supported and contractor-pure PAOs (see APL 95-1-1, section 14).

(4) A CAO is a flight activity which does not meet the qualifications for public aircraft status in 49 USC 40125. The contractor maintains responsibility for all aspects of the flight activity and verifies compliance with USACE and Army cybersecurity in APL 95-1-1. CAO flights must be conducted according to required federal, state, and local requirements for SUAS flights, and under the supervision of a USACE-TA per APL 95-1-1. Contractor flights are not permitted without prior written approval (signed paper copy, e-mail, or text message) by the TA.

(5) Third party operations on or near USACE projects introduce potential for loss of information protection and security regarding Army activities. Third party SUAS

operations conducted for commercial purposes must have District Commander/Lab Director approval according to 36 CFR 327. (See APL 95-1-1, section 14)

Note. The TA must e-mail HQAviation@usace.army.mil with the data from the contractor notification and submit a close-out report after the flight(s). If the flight is cancelled or delayed, the close-out report is still required to notify USACE HQ Aviation per APL 95-1-1.

e. USACE Missions. (33-8.e)

(1) SUACs Physically Capable. SUACs are prohibited from performing crewmember duties without first ensuring they are physically capable. ATPMs must ensure all SUACs complete and sign the ENG Form 6150 (Small UAS Operator - Health Self-Assessment Tool) (see para 33-10.b) annually. As a part of the Operational Risk Management process, SUACs must review their medical requirements prior to each mission. See APL 95-1-1 (and FAA-H-8083-2) for information on aviation personnel medical requirements.

(2) All SUAS Mission Planning Procedures. SUAS missions must be planned, approved, executed, and debriefed utilizing MARS according to (and currently only available in) APL 95-1-1.

f. Crewed Aircraft. (33-8.f)

(1) All PAO contract pilots must meet the qualification, evaluation, and currency requirements of AR 95-20.

(2) All contractor-owned aircraft must be registered and equipped according to the requirements of AR 95-20, Army Airworthiness Authority, and/or FAA-issued Air Worthiness Certificate, as required.

(3) All contractor flight and ground operations must follow the requirements of AR 95-20.

33-9. Figures and Tables.

Not Applicable.

33-10. Checklists and Forms.

a. DD Form 2977, Deliberate Risk Assessment Worksheet
(https://armypubs.army.mil/ProductMaps/PubForm/Details.aspx?PUB_ID=104201)
(33-10.a)

b. ENG Form 6150, Small UAS Operator - Health Self-Assessment Tool
(<https://www.publications.usace.army.mil/USACE-Publications/Engineer-Forms/>)
(33-10.b)

Chapter 34 Confined Space

34-1. References.

- a. ANSI/ASSE A10.43, Confined Spaces in Construction and Demolition Operations (<https://www.ansi.org>) (34-1.a)
- b. ANSI/ASSP Z117.1, Safety Requirements for Entering Confined Spaces (<https://www.ansi.org>) (34-1.b)
- c. NFPA 306, Standard for the Control of Gas Hazards on Vessels (<https://www.nfpa.org/Codes-and-Standards>) (34-1.c)
- d. NFPA 350, Guide for Safe Confined Space Entry and Work (<https://www.nfpa.org/Codes-and-Standards>) (34-1.d)
- e. 29 CFR 1910.146, Permit-Required Confined Spaces (<https://www.govinfo.gov/content/pkg/CFR-2020-title29-vol5/pdf/CFR-2020-title29-vol5-sec1910-146.pdf>) (34-1.e)
- f. 29 CFR 1915.7, Competent Person, Confined Space in Ships and Vessels (<https://www.govinfo.gov/content/pkg/CFR-2020-title29-vol7/pdf/CFR-2020-title29-vol7-sec1915-7.pdf>) (34-1.f)
- g. 29 CFR 1915 Subpart B, Confined and Enclosed Spaces and Other Dangerous Atmospheres in Shipyard Employment (<https://www.govinfo.gov/content/pkg/CFR-2020-title29-vol7/pdf/CFR-2020-title29-vol7-part1915-subpartB.pdf>) (34-1.g)
- h. 29 CFR 1926 Subpart AA Confined Spaces in Construction (<https://www.govinfo.gov/content/pkg/CFR-2020-title29-vol8/pdf/CFR-2020-title29-vol8-part1926-subpartAA.pdf>) (34-1.h)

34-2. Definitions.

- a. Attendant. An individual assigned to monitor outside of a single confined space and provide support or respond as required for the safety of the Entrants. (34-2.a)
- b. Competent Person, Confined Spaces in Ships and Vessels (CPCSSV). An individual, designated in writing by the employer, responsible for testing, inspecting, and evaluating spaces and meets the requirements of 29 CFR 1915.7. (34-2.b)
- c. Confined Space. A space that meets all of the following: (34-2.c)
 - (1) Is large enough and so configured that a person can bodily enter and perform assigned work.

(2) Has limited or restricted means for entry and exit.

(3) Is not designed for continuous worker occupancy.

d. Confined Space on a Ship or Vessel. A compartment of small size and limited access such as a double bottom tank, cofferdam, or other space that is enclosed by bulkheads and overheads and can readily create or aggravate a hazardous exposure. (34-2.d)

e. Enclosed Space. Any space, other than a confined space, which is enclosed by bulkheads and overhead. It includes cargo holds, tanks, quarters, and machinery and boiler spaces. (34-2.e)

f. Enter with Restrictions. Refers to entry into a confined space on a ship or vessel when engineering controls, PPE and time limitations are imposed by the CPCSSV. (34-2.f)

g. Entrant. An individual authorized by the Entry Supervisor to enter a confined space and perform an assigned task or operation. (34-2.g)

h. Entry Permit. The document that lists the hazards, controls, and procedures required for entry into a permit-required confined space (PRCS). See non-mandatory ENG Form 6208 (Permit-Required Confined Space Entry) (see para 34-10.d). (34-2.h)

i. Entry Supervisor. The QP responsible for determining if acceptable entry conditions are present at a PRCS. They will authorize entry, oversee entry operations, and terminate entry as required by this manual. (34-2.i)

j. Evacuation. An unaided emergency exit or self-rescue from a confined space. This action may result from the Entrant's own decision or by a command from outside the space. (34-2.j)

k. Hazardous Atmosphere. An atmosphere that exists or has the potential to exist and is capable of causing death, incapacitation, impairment of ability to self-rescue, injury, or illness. Examples include oxygen deficiency or enrichment, flammability or explosivity by gas, vapor, dust, or toxicity. (See 29 CFR 1926.1202 (29 CFR 1926 Subpart AA)) (34-2.k)

l. Lower Explosive Limit/Lower Flammability Limit (LEL/LFL). The lowest concentration (that is, percentage) of a gas or a vapor in air capable of producing a flash of fire in presence of an ignition source (for example, arc flash, flame, heat). (34-2.l)

m. Non-Permit Confined Space (NPCS). A confined space that does not contain or have the potential to contain a hazard capable of causing death or serious physical harm. (34-2.m)

n. Oxygen Deficient Atmosphere. An atmosphere with an oxygen content below 19.5% by volume. (34-2.n)

o. Oxygen Enriched Atmosphere. An atmosphere containing more than 23.5% oxygen by volume. (34-2.o)

p. Oxygen Enriched Atmosphere, on a Ship or Vessel. An atmosphere containing more than 22% oxygen by volume. (34-2.p)

q. Permit-Required Confined Space (PRCS). A confined space that has one or more of the following characteristics: (34-2.q)

(1) Contains or has the potential to contain a hazardous atmosphere.

(2) Contains a material that has the potential for engulfing an Entrant.

(3) Has an internal configuration such that an Entrant could be trapped or asphyxiated by inwardly converging walls or by a floor that slopes downward and tapers to a smaller cross-section.

(4) Contains any other recognized serious safety or health hazard.

r. Purging. The replacement of a flammable, indeterminate, or high-oxygen-bearing atmosphere with another gas that, when complete, results in a non-flammable final state. (34-2.r)

s. Rescue Service. A team of qualified responders with the training, expertise, and equipment to readily provide confined space rescue. (34-2.s)

t. Safe for Workers, on a Ship or Vessel. Denotes a confined space on floating plant that meets the following criteria: (34-2.t)

(1) The oxygen content of the atmosphere is at least 19.5% and below 22% by volume.

(2) The concentration of flammable vapors is below 10% of the LEL.

(3) Any toxic materials in the atmosphere associated with cargo, fuel, tank coatings, or inserting media are within permissible concentrations at the time of the inspection.

34-3. Personnel Required Qualification/Training.

a. All personnel working in or around a confined space must receive training:
(34-3.a)

- (1) Before they are first assigned confined space duties.
- (2) Before there is a change in assigned confined space duties.
- (3) Whenever there is a change in confined space operations that presents a hazard; about which an individual has not previously been trained.
- (4) Wherever the employer has reason to believe there are deviations from the confined space entry procedures or there are inadequacies in the individual's knowledge or use of the entry procedures.
- (5) If none of the conditions exist in paragraph 34-3.a, retraining must be conducted at least annually.

Note. Individuals who work around a confined space but are not directly engaged in confined space entries must be trained to an awareness level to ensure they can identify and avoid confined spaces.

b. Initial training must include the following: (34-3.b)

- (1) How to understand and recognize the characteristics of a confined space.
- (2) How to identify, evaluate, and control the hazards of a confined space.
- (3) Mode, signs, symptoms, and consequences related to exposures.
- (4) How to understand and recognize the hazards, signals, or warnings that require immediate evacuation.
- (5) The roles and responsibilities in conducting an entry.
- (6) How to fill out a confined space permit and other confined space entry forms.
- (7) Rescue exercise(s) applicable to the space(s) on the site.
- (8) Hands-on exercise on the use, calibration, and maintenance of monitoring equipment, communication equipment, and retrieval equipment.
- (9) Instruction on the use and donning of appropriate PPE needed for safe entry and exit.

c. Refresher Training. All Entrants, Attendants, Entry Supervisors, and rescue personnel must complete refresher training at least annually. The training must include, as a minimum: (34-3.c)

- (1) Review of entry procedures.
- (2) Rescue exercise.
- (3) The use of air monitoring, PPE, and retrieval equipment.

d. Train Entry Supervisors to: (34-3.d)

- (1) Know the procedures of the written site-specific Confined Space Plan.
- (2) Know the requirements of this manual and all other applicable safety regulations (for example, OSHA) pertaining to the confined space entry.
- (3) Know the hazards the entry team may face during entry.
- (4) Know the signs and symptoms of exposures.
- (5) Know how to complete and cancel the entry permit.
- (6) Know how to conduct atmospheric testing prior to and throughout the entry.
- (7) Choose the equipment necessary and ensure it is place prior to the entry.
- (8) Know the hazard levels associated with the confined space and how to summon rescue services.
- (9) Know and understand the roles of all the Entrants, Attendants, and rescue personnel.

e. Train Entrants to: (34-3.e)

- (1) Know how to properly use necessary equipment (for example, fall protection, atmospheric monitoring, communication methods, PPE). See chapter 5 for PPE and chapter 21 for fall protection.
- (2) Know the hazards that will be present during confined space entries and any warning signs or symptoms of exposure.
- (3) Know how to alert and communicate to the Attendant if a dangerous situation arises.

(4) Know to immediately exit the space whenever an Attendant or Entry Supervisor orders an evacuation.

f. Train Attendants to: (34-3.f)

(1) Know how to properly use necessary equipment (for example, atmospheric monitoring, communication methods, PPE) (see chapter 5).

(2) Know the hazards that will be present during confined space entries and any warning signs or symptoms of exposure.

(3) Know how to fill out and maintain the documentation related to the confined space entry.

(4) Know how to alert and order evacuation if unsafe conditions are present.

(5) Know how to perform non-entry rescue, if applicable, or when to summon rescue and emergency services.

(6) Know how to warn any unauthorized person of the need to stay away from the confined space work.

(7) Know how to inform the Entrants and Entry Supervisor if any unauthorized persons have entered the PRCS.

(8) Know that they are to perform no other duties that will interfere with their assigned roles.

g. Train the CPCSSV to: (34-3.g)

(1) Know how to properly use necessary equipment (for example, atmospheric monitoring, communication methods, PPE) (see chapter 5).

(2) Know how to conduct inspections and tests according to 29 CFR 1915.7.

(3) Know how to implement the written or oral information or instructions provided by a Marine Chemist, Coast Guard authorized persons, or CIH.

(4) Know how to document the records according to 29 CFR 1915 Subpart B.

h. Train in-house rescue personnel to: (34-3.h)

(1) Know how to respond to the hazard level (see para 34-8.h).

(2) Know how to prepare and set up the necessary equipment for rescue.

(3) Know how to apply the rescue requirements of NFPA 350.

(4) Complete training annually by means of simulated rescue operations in which they remove dummies, manikins, or actual persons from the actual confined space or from representative confined spaces. Representative confined spaces will, with respect to opening size, configuration, and accessibility, simulate the types of confined spaces from which rescue is to be performed.

(5) Provide basic first aid and CPR response. Ensure that at least one member of the rescue team or service holds a current certification in basic first aid and CPR and is available. (See chapter 3)

Note. If contracted rescue services are used, verify they have the training and knowledge necessary as required by this paragraph 34-3.

34-4. Roles and Responsibilities.

a. Owner/Operator. Ensure contractors are aware of the confined space hazards where work will be performed and provide any other necessary information. (34-4.a)

b. Qualified Person (QP). The QP is responsible for identifying and conducting surveys for confined spaces (see para 34-8.b). Additionally, the QP must: (34-4.b)

(1) Label PRCS.

(2) Develop confined space programs for USACE operations (see para 34- 7.e).

c. Entry Supervisor. The Entry Supervisor must develop site-specific Confined Space Plans and oversee and direct all PRCS entry operations. Additionally, the Entry Supervisor must: (34-4.c)

(1) Remain onsite at all times during PRCS entries.

(2) Verify all applicable procedures (for example, ventilation, fall protection) are in place prior to confined space entry.

(3) Ensure all energy sources, mechanical hazards, and equipment is controlled, disconnected, or isolated prior to issuing an entry permit (see para 12-8.a).

(4) When ventilation is supplied into the space, ensure it is from a clean source.

(5) Ensure that the hazardous atmosphere is properly exhausted and does not enter or accumulate in unapproved areas.

(6) Complete and sign the entry permit. See non-mandatory ENG Form 6208 (Permit-Required Confined Space Entry) (see para 34-10.d).

(7) Ensure pre-entry testing and continuous monitoring of the confined space atmosphere is conducted. See non-mandatory ENG Form 6205 (Atmospheric Testing) (see para 34-10.b).

(8) Remove unauthorized individuals who enter or attempt to enter a PRCS during operations.

(9) Ensure safe conditions are maintained throughout the entry and operations.

(10) Cancel the permit and reissue a new permit whenever there are new hazards or changed conditions. Update the AHA accordingly.

(11) Ensure Attendant(s) can execute the emergency response and rescue plan.

(12) Coordinate with rescue services to ensure they are aware of the confined space entry and are capable of supporting according to the identified hazard level (see para 34-8.h).

d. Entrant. The Entrant(s) is responsible for following the entry requirements and procedures according to the Confined Space Plan. The authorized Entrant must: (34-4.d)

Note. The Entry Supervisor can also serve as an Entrant if so trained and qualified according to paragraph 34-3.e.

(1) Understand the potential hazards of the confined space.

(2) Review and sign the entry permit when a permit is required.

(3) Properly use equipment.

(4) Establish clear communication methods with Attendant(s).

(5) Enter the confined space only when directed by the Entry Supervisor or after the completion of a pre-entry evaluation.

(6) Notify the Attendant and immediately exit the space if any symptoms of exposure, an emergency, or unacceptable conditions occur.

(7) Exit the confined space immediately if symptoms, warning signs, or unacceptable conditions occur or when directed to do so by the Attendant or Entry Supervisor.

e. Attendant. The Attendant is responsible for following the entry requirements and procedures according to the Confined Space Plan. The Attendant must: (34-4.e)

Note. The Entry Supervisor can also serve as an Attendant if so trained and qualified according to paragraph 34-3.f.

(1) Understand the hazards of the confined space.

(2) Review and sign the entry permit.

(3) Establish clear communication methods with the Entrant(s).

(4) Remain outside the assigned PRCS during entry operations until relieved by another Attendant or all Authorized Entrants have left the space and the permit is canceled.

(5) Maintain a count of Entrants. See non-mandatory ENG Form 6207 (Confined Space Entrant Log) (see para 34-10.c).

(6) Prevent unauthorized access to the confined space and notify the Entry Supervisor of unauthorized individuals.

(7) Order the evacuation of the confined space upon identification of a hazardous condition inside or outside of the confined space.

(8) Recognize signs and symptoms related to the chemical, physical, biomechanical, biological, and psychological hazards within the space and determine the appropriate action required.

(9) Summon rescue or emergency services, as required.

(10) Perform non-entry rescue, as required.

f. Rescue Personnel. The role of a confined space rescue service, whether in house or outside rescue service, is to enter a space and perform a rescue. The rescue service must: (34-4.f)

(1) Respond in a timely manner, based on the hazards and conditions of the space.

(2) Provide a team of sufficient size and technical training to perform the rescue.

(3) Have the proper equipment and retrieval devices.

(4) Provide basic first aid and CPR response.

(5) Notify the Entry Supervisor if their service availabilities and timeliness of response changes.

g. Competent Person, Confined Spaces in Ships and Vessels (CPCSSV). The CPCSSV must follow the entry requirements and procedures according to the Confined Space Program and 29 CFR 1915 Subpart B. Additionally, USACE CPCSSVs must: (34-4.g)

(1) Develop and implement a site-specific Confined Space Program meeting the requirements of 29 CFR 1915 Subpart B and those defined in this chapter.

(2) Before and during entry into spaces, test the atmosphere for oxygen content, flammability, and toxicity, and record the results according to the requirements of 29 CFR 1915.7. See non-mandatory ENG Form 6205 (Atmospheric Testing) (see para 34-10.b).

(3) Prior to starting hot work, test the confined space to confirm there is no toxic, corrosive, or irritating chemicals present in the air. Evaluate and document the results before starting the work. Continuously monitor the air to ensure acceptable atmospheric levels are maintained. See chapter 9 for additional hot work requirements and chapter 10 for welding, cutting, and brazing activities.

(4) Label all confined spaces according to 29 CFR 1915 Subpart B and maintain a copy of the inventory onsite and at the land-based office (see para 34-8.b).

34-5. Inspection Requirements.

Prior to start of work, conduct documented inspections for equipment according to the manufacturer's instructions to ensure it is in good condition and when conditions require, is intrinsically safe. Inspections will include but are not limited to the following:

a. Atmospheric testing and monitoring equipment, to include documentation of calibration. (34-5.a)

b. Ventilation equipment. (34-5.b)

c. PPE (see chapter 5). (34-5.c)

d. Fall protection equipment (see chapter 21). (34-5.d)

e. Lighting (see chapter 7). (34-5.e)

f. Ladders or other equipment necessary for Entrant access and egress. (34-5.f)

g. Barriers to prevent unauthorized entry. (34-5.g)

h. Rescue equipment. (34-5.h)

- i. Communication equipment. (34-5.i)
- j. Other required equipment for entry or rescue. (34-5.j)

34-6. Activity Hazard Analysis (AHA) Requirements.

Develop AHAs according to paragraphs 1-6 or 2-6, as applicable, for each confined space entry, to include the following:

- a. Identify all existing or potential hazards (for example, mechanical, electrical, physical, chemical, atmospheric, biological, psychological) of the operation in the AHAs. (34-6.a)
- b. If the PRCS has been updated to include alternate entry procedures or has been reclassified, the Entry Supervisor will update the AHA. See ENG Form 6204 (Alternate Entry Procedure) or ENG Form 6210 (Confined Space Reclassification) as an example (see paras 34-10.a and 34-10.e). (34-6.b)
- c. List all trained personnel involved in a confined space rescue in the approved AHA(s). (34-6.c)

34-7. Minimum Plan Requirements.

a. Confined Space Program (USACE Only). A written Confined Space Program must be developed by a QP when USACE employees are exposed to confined spaces. The Confined Space Program must be reviewed at least annually and include the following: (34-7.a)

- (1) Roles and Responsibilities for all personnel covered by the program.
- (2) Confined Space Survey(s), Inventory, and labeling procedures.
- (3) Requirement for each facility to develop a Site-Specific Confined Space Plan (see para 34-7.b).
- (4) Procedures to ensure all personnel exposed to confined spaces are provided with appropriate training.
- (5) Procedures to provide effective in-house rescue service when applicable.

Note. See paragraph 34-4.g, CPCSSV, for Confined Space Program requirements on ships and vessels.

b. Confined Space Plan. Prior to beginning PRCS work, the Entry Supervisor must develop and submit a written Site-Specific Confined Space Plan to USACE

supervisor for approval or to the KO or COR for acceptance. The plan will include at least the following: (34-7.b)

- (1) Detailed description of the activity being performed.
- (2) Confined Space Permit process that identifies hazards or concerns and the control measures that will be implemented to control to an acceptable level.
- (3) Assignment of personnel and their roles and responsibilities. Include necessary information/documentation to support qualification/training of such persons.
- (4) Inspection and oversight methods to ensure adherence to the plan.
- (5) Equipment required for each entry.
- (6) Procedures for conducting atmospheric monitoring.
- (7) Communication methods used.
- (8) Confined Space Inventory.
- (9) Labeling procedures.
- (10) Rescue Plan to include anticipated hazard levels.

c. If any of the following conditions or events occur, stop all confined space work, update the Site-Specific Confined Space Plan, and resubmit it for acceptance prior to resuming entry if: (34-7.c)

- (1) Additional hazards are identified.
- (2) There is a change in the configuration, conditions, contents, or operation of the space.
- (3) There is a change in assigned duties.
- (4) Entrants must evacuate, or if there are changes in the overall use of the space that may increase the hazards to the Entrant.
- (5) A new confined space is discovered or created due to construction or demolition activity.
- (6) An accident or near miss occurs.

34-8. General Requirements.

a. General. The requirements of the chapter apply to all confined space work performed in permanent fixed facilities, construction sites according to 29 CFR 1926.1201 (29 CFR 1926 Subpart AA), and USACE floating plant operations and/or floating plant repair and maintenance operations. Contractor floating plant operations will follow 29 CFR 1915 Subpart B. This chapter does not apply to underground construction work (for example, tunneling) in a confined space. (See chapter 26) (34-8.a)

(1) To prevent unauthorized entry during confined space work, place barricades and guardrails at appropriate locations.

(2) Personnel working in and around confined spaces must notify their supervisor prior to entry.

b. Confined Space Identification and Evaluation. (34-8.b)

(1) The QP must identify each confined space according to 29 CFR 1910.146 and 29 CFR 1926 Subpart AA. Once a confined space has been identified, conduct a survey to evaluate the existing and potentially hazardous conditions. Document the survey and include it in the Confined Space Plan inventory. See non-mandatory ENG Form 6212 (Confined Space Survey) (see para 34-10.g).

Note. When surveys identify a NPCCS, no Confined Space Plan or permit is required.

(2) The QP must label each PRCS with a posted sign or tag at the entrance to prohibit unauthorized entry. The labeling must meet the requirements of 29 CFR 1910.146, 29 CFR 1926 Subpart AA, 29 CFR 1915 Subpart B, ANSI Z117 or ANSI A10.43.

(3) The CPCSSV must identify confined spaces, conduct a survey to evaluate the hazards, label the space according to 29 CFR 1915 Subpart B, and maintain a copy of the inventory onsite and at the land-based office.

(4) Upon entry into the confined space, the CPCSSV will post additional signage if the confined space contains the following:

(a) If the confined space has an oxygen deficient atmosphere, the space will be labeled as “Not Safe for Workers.”

(b) If the confined space has an oxygen-enriched atmosphere, the space will be labeled as “Not Safe for Workers – Not Safe for Hot Work.”

(c) If the confined space contains a flammable gas or vapor at 10% or higher than the LEL for the gas, then the space will be labeled “Not Safe for Workers – Not Safe for Hot Work.”

(d) If the confined space contains an atmosphere that is toxic, corrosive, or irritants that exceed the OEL, then the space will be labeled as “Not Safe for Workers.”

c. Entry Requirements. (34-8.c)

(1) Monitor all confined spaces prior to and continuously during entry to ensure acceptable atmospheric levels are present throughout all operations. Perform air testing prior to ventilating the space. Document the results of the testing on an atmospheric monitoring form. Include the name of the individual performing the testing, the make, model, and serial number of the air monitoring device, and last calibration date. See non-mandatory ENG Form 6205 (Atmospheric Testing) (see para 34-10.b).

(2) If atmospheric hazards are present within the confined space, purge or ventilate, or both, to ensure acceptable atmospheric levels are maintained and controlled, prior to and throughout the entry.

(3) Test the atmosphere in the order specified below. The atmosphere is considered acceptable when the following conditions exist:

(a) Oxygen concentration:

(a-1) Construction and General Industry: 19.5% to 23.5%.

(a-2) Ships and Vessels: 19.5% to below 22%. Entry is prohibited when the LEL is greater than 10% unless it is required for emergency rescue.

(b) Flammable atmosphere: <10% of LFL.

(c) Toxic dust, vapor, or gas is maintained below the OEL.

d. Entry Permits. (34-8.d)

(1) The Entry Supervisor must complete an entry permit, documenting the appropriate elimination, mitigation, and control measures to be implemented for all existing and potential hazards. See non-mandatory ENG Form 6208 (Permit-Required Confined Space Entry) (see para 34-10.d).

(2) Permits are limited to one shift. If work operations exceed one shift, the permit must be reissued.

(3) Make available the permit and any other documentation specific to the entry at the confined space location.

(4) Mark the permit as canceled after the date and time stated on the permit has expired, the work is completed, or there is a change in conditions that requires cancellation.

(5) Once the PRCS operation has concluded, hold a debrief to review the written Confined Space Plan and any hazards encountered or created.

(6) Keep cancelled permits for at least one year for Entry Supervisors to review prior to entering a confined space.

e. Reclassification. If the Entry Supervisors determines the PRCS poses no actual or potential atmospheric hazards and if all hazards within the space are eliminated or isolated prior to entry, the PRCS may be reclassified as a NPCS for as long as the non-atmospheric hazards remain eliminated or isolated according to 29 CFR 1910.146 or 29 CFR 1926.1203 (29 CFR 1926 Subpart AA). (34-8.e)

(1) Control of atmospheric hazards through forced air ventilation does not constitute elimination.

(2) The reclassification must be documented and available at the confined space location. See non-mandatory ENG Form 6210 (Confined Space Reclassification) (see para 34-10.e).

(3) If hazards arise in the reclassified space, employees must exit the space and the space must be reevaluated.

(4) Keep documentation of entries conducted under reclassification for at least one year for Entry Supervisors to review prior to entering a confined space.

f. Alternate Entry. If the Entry Supervisor determines the PRCS has no potential for any other hazard, other than atmospheric, and is controlled with continuous ventilation (see para 34-8.g) and monitoring (see para 34-8.c), alternate entry procedures can be followed according to 29 CFR 1910.143 or 29 CFR 1926.1203. (34-8.f)

(1) Entry Supervisor must be able to demonstrate that continuous forced air ventilation alone is sufficient to maintain safe entry conditions.

(2) The alternate entry must be documented and available at the confined space location. See non-mandatory ENG Form 6204 (Alternate Entry Procedure) (see para 34-10.a).

(3) If hazards arise in the space, employees must exit the space and the space must be reevaluated.

(4) Keep documentation of entries conducted under alternate entry for at least one year for Entry Supervisors to review prior to entering a confined space.

g. Confined Space Hazard Control. (34-8.g)

(1) Ventilation.

(a) When a hazardous atmosphere is present, use natural or mechanical ventilation controls to provide continuous fresh air into the confined space based on the work that will be performed.

(b) Natural ventilation may be used to supply adequate breathing quality air within the confined space.

(c) Mechanical Ventilation.

(c-1) General (that is, Dilution) Ventilation. Air supply must be from a clean source that does not increase the hazards in the space. When continuous forced air is used, direct the ventilation towards the immediate areas where an Entrant will be present.

(c-2) Local Exhaust Ventilation (LEV). When hot work, painting, or the use of a combustible or flammable material is necessary in the confined space, utilize LEV to capture and remove contaminants at the source.

(c-3) If a confined space contains an atmospheric hazard controlled by mechanical ventilation, use an audible or visual warning system to alert individuals in the event of the failed system.

(2) Isolation. Install an isolation barrier to prevent any liquids or free flowing solids from entering the confined space when work is being conducted.

h. Confined Space Rescue. (34-8.h)

(1) Base the confined space rescue plan on the hazard level. Until a confined space can be proven to have no potential for hazards and no potential difficulty associated with the rescue of Entrants, the rescue service must be able to meet the requirements of the following hazard levels:

(a) Hazard Level 1. A confined space that does not contain any potential or recognized Hazards, but could require technical rescue due to its configuration that would prohibit Entrants from being easily removed should a worker become incapacitated. A fully trained rescue team must be available to respond within five minutes to the site and is capable of setup and rescue entry within 15 minutes of arrival onsite.

(b) Hazard Level 2. A confined space that does not contain life-threatening or other potentially IDLH hazards, but does contain potential or recognized hazards that could incapacitate Entrants or prevent them from exiting the space without assistance. A fully trained rescue team must be onsite, equipped, and capable of setup for safe entry for rescue within 12 to 15 minutes of incident occurrence.

(c) Hazard Level 3. A confined space that contains life-threatening hazards requiring immediate intervention (that is, IDLH atmosphere). A fully trained rescue team must be onsite and standing by in the immediate area throughout the entire entry. The rescue team must be dedicated to a single entry with no other responsibilities and will be completely set up and capable of rescue entry within two minutes of incident occurrence.

(2) Coordinate with applicable federal, state, or local municipal rescue services to ensure they are capable of supporting the entry.

(3) In-house or contract provided rescue services will be evaluated to ensure they are fully capable of performing the rescues within the required timeframe. See ENG Form 6211 (Rescue Service Evaluation) as an example (see para 34-10.f).

34-9. Figures and Tables.

Not Applicable

34-10. Checklists and Forms.

a. ENG Form 6204, Alternate Entry Procedure (non-mandatory)
(https://publications.usace.afpims.mil/LinkClick.aspx?fileticket=3FTU_r7b2zQ%3d&tabid=1=16438&portalid=76&mid=43543) (34-10.a)

b. ENG Form 6205, Atmospheric Testing (non-mandatory)
(https://publications.usace.afpims.mil/LinkClick.aspx?fileticket=Fe-PrOnk_lg%3d&tabid=16438&portalid=76&mid=43543) (34-10.b)

c. ENG Form 6207, Confined Space Entrant Log (non-mandatory)
(<https://publications.usace.afpims.mil/LinkClick.aspx?fileticket=IG8N14A5H4g%3d&tabid=16438&portalid=76&mid=43543>) (34-10.c)

d. ENG Form 6208, Permit-Required Confined Space Entry (PRCS) (non-mandatory)
(<https://publications.usace.afpims.mil/LinkClick.aspx?fileticket=P8xWGmdifEY%3d&tabid=16438&portalid=76&mid=43543>) (34-10.d)

e. ENG Form 6210, Confined Space Reclassification (non-mandatory)
(<https://publications.usace.afpims.mil/LinkClick.aspx?fileticket=BVmOXae5IUI%3d&tabid=16438&portalid=76&mid=43543>) (34-10.e)

f. ENG Form 6211, Rescue Service Evaluation (non-mandatory)
(<https://publications.usace.afpims.mil/LinkClick.aspx?fileticket=RADyavIF2UY%3d&tabid=16438&portalid=76&mid=43543>) (34-10.f)

g. ENG Form 6212, Confined Space Survey (non-mandatory)
(https://publications.usace.afpims.mil/LinkClick.aspx?fileticket=ddYCx6l_KB0%3d&tabid=16438&portalid=76&mid=43543) (34-10.g)

Chapter 35

Sanitation

35-1. References.

a. ANSI/ASSP A10.25, Sanitation in Construction
(<https://webstore.ansi.org/>) (35-1.a)

b. ANSI/ISEA Z358.1, Emergency Eyewash and Shower Equipment
(<https://webstore.ansi.org/>) (35-1.b)

c. ANSI/SAI Z4.3, Sanitation – Non-Sewered Waste-Disposal Systems – Minimum Requirements (<https://webstore.ansi.org/>) (35-1.c)

d. EP 310-1-6a, Sign Standards Manual,
(<https://www.publications.usace.army.mil/USACE-Publications/Engineer-Pamphlets/>)
(35-1.d)

e. EP 310-1-6b, Sign Standards Manual, VOL 2
(<https://www.publications.usace.army.mil/USACE-Publications/Engineer-Pamphlets/>)
(35-1.e)

f. EPA Integrated Pest Management Principles
(<https://www.epa.gov/safepestcontrol/integrated-pest-management-ipm-principles>)
(35-1.f)

g. FDA Food Code 2009: Chapter 4 - Equipment, Utensils & Linens
(<https://www.fda.gov/food/fda-food-code/food-code-2009>) (35-1.g)

h. NAVMED P-5010-6, Water Supply Afloat
(<https://www.med.navy.mil/Directives/>) (35-1.h)

i. NSF/ANSI 12, Automatic Ice Making Equipment
(<https://webstore.ansi.org/standards/nsf/nsfans122018>) (35-1.i)

j. TB MED 530/NAVMED P-5010-1/AFMAN 48-147 IP, Tri-Service Food Code
(https://armypubs.army.mil/ProductMaps/PubForm/TB_Cal.aspx) (35-1.j)

- k. TB MED 531, Facility Sanitation Controls and Inspections
(https://armypubs.army.mil/ProductMaps/PubForm/TB_Cal.aspx) (35-1.k)
- l. TB MED 577 NAVMED P-5010-10/AFMAN 48-138 IP, Sanitary Control and Surveillance of Field Water Supplies
(https://armypubs.army.mil/ProductMaps/PubForm/TB_Cal.aspx) (35-1.l)
- m. U.S. Public Health Service (USPHS) - FDA, Food Code
(<https://www.fda.gov/media/110822/download>) (35-1.m)
- n. 29 CFR 1910.22, General Requirements (Walking-Working Surfaces)
(<https://www.govinfo.gov/content/pkg/CFR-2020-title29-vol5/pdf/CFR-2020-title29-vol5-sec1910-22.pdf>) (35-1.n)
- o. 29 CFR 1910.141, Sanitation (<https://www.govinfo.gov/content/pkg/CFR-2020-title29-vol5/pdf/CFR-2020-title29-vol5-sec1910-141.pdf>) (35-1.o)
- p. 29 CFR 1915.81, Housekeeping (General Working Conditions)
(<https://www.govinfo.gov/content/pkg/CFR-2021-title29-vol7/pdf/CFR-2021-title29-vol7-sec1915-81.pdf>) (35-1.p)
- q. 29 CFR 1926.32, Definitions (General Safety and Health Provisions)
(<https://www.govinfo.gov/content/pkg/CFR-2020-title29-vol8/pdf/CFR-2020-title29-vol8-sec1926-32.pdf>) (35-1.q)
- r. 29 CFR 1926.51, Sanitation (<https://www.govinfo.gov/content/pkg/CFR-2020-title29-vol8/pdf/CFR-2020-title29-vol8-sec1926-51.pdf>) (35-1.r)
- s. 40 CFR 141, National Primary Drinking Water Regulations
(<https://www.govinfo.gov/content/pkg/CFR-2020-title40-vol25/pdf/CFR-2020-title40-vol25-part141.pdf>) (35-1.s)
- t. 40 CFR 142, National Primary Drinking Water Regulations Implementation
(<https://www.govinfo.gov/content/pkg/CFR-2020-title40-vol25/pdf/CFR-2020-title40-vol25-part142.pdf>) (35-1.t)
- u. 40 CFR 143, Other Safe Drinking Water Act Regulations
(<https://www.govinfo.gov/content/pkg/CFR-2020-title40-vol25/pdf/CFR-2020-title40-vol25-part143.pdf>) (35-1.u)

35-2. Definitions.

- a. Contaminated. Any material which by reason of its action upon, within, or to a person is likely to cause physical harm. (35-2.a)

b. Food Handler. A food handler is an employee of a food facility/establishment who is involved in the preparation, storage, service, or handling of food products. Anyone who prepares food or who may come in contact with food products, food utensils or equipment is a food handler. (35-2.b)

Note. Non-food establishment employees participating in food handling (for example, organizational days) should consult with local and state requirements for required food safety training.

c. Hand Washing Facility. A washing facility for hand washing with potable water, cleansing agent, and drying mechanism. (35-2.c)

d. Hygienic. Conducive to maintaining health and preventing disease, especially by being clean; sanitary. (35-2.d)

e. Potable Water. Water that meets the standards for drinking purposes of the state or local AHJ, or water that meets the quality standards prescribed by the U.S. EPA National Primary Drinking Water Regulations (40 CFR 141). See also TB MED 577 NAVMED P-5010-10/AFMAN 48-138 IP and NAVMED P-5010-6. (35-2.e)

f. Tepid. Tepid water is 60° F - 100° F (15.6° C - 37.8° C). (35-2.f)

g. Toilet Facility. A fixture maintained within a toilet room for the purpose of defecation or urination, or both. A toilet facility may be a toilet, water closet, commode, urinal, or similar. (35-2.g)

h. Toilet Room. An enclosure containing one or more toilet facilities. (35-2.h)

i. Toilet Seat Cover. A disposable or removable seat covering intended to protect the user from direct contact with the toilet seat. (35-2.i)

j. Vermin. Insects, birds, and other animals, such as rodents and feral cats, that may create safety and health hazards for employees. (35-2.j)

k. Washing Facility. A facility near the work site that can be used to provide adequate washing for employees. (35-2.k)

35-3. Personnel Required Qualification/Training.

a. Food Handlers. (35-3.a)

(1) Food handlers are not required to have a general medical exam, but must obtain a statement from a licensed physician, physician's assistant, or nurse practitioner attesting that they are free of communicable diseases.

(2) Training. Food handlers must complete food service sanitation training annually according to TB MED 530/NAVMED P-5010-1/AFMAN 48-147 IP, and local and state laws. Food handlers must meet the following:

(a) Trained to perform their duties in a safe manner and with the ability to protect themselves and others from intentional and unintentional food contamination.

(b) Trained in the basic principles of food safety, which includes but is not limited to the CDC's five foodborne illness risk factors:

(b-1) Food from unsafe sources.

(b-2) Inadequate cooking.

(b-3) Improper holding/time-temperature.

(b-4) Contaminated equipment/cross contamination protection. Discussion must include general sanitation and food allergens.

(b-5) Poor personal hygiene. Discussion must include the impact to public health, communicable diseases transmitted by food handlers, and employee health and hygiene.

(3) Each food handler must receive a minimum of 4 hours of food safety refresher training annually to reinforce training subjects identified in paragraph 35-3.a(2). Exceptions to this requirement are employees who do not prepare food and food handlers who serve in a supervisory role and maintain a Food Protection Manager Certification.

(4) Refresher training.

(a) Must be conducted within a 12-month period beginning no earlier than one month following an employee's initial training.

(b) May be executed incrementally throughout the year to achieve the 4-hour requirement.

b. Extermination license/certification. The determination to use licensed exterminators/pest control personnel must be based on the necessary methods required by the AHA, analysis of SDSs, manufacturer's recommendations, this manual, applicable federal, state, and requirements. (35-3.b)

35-4. Roles and Responsibilities.

a. Employers must establish and maintain hygienic sanitation provisions for all employees in all places of employment as specified in the following paragraphs. (35-4.a)

b. Employees must follow established hygienic sanitation provisions while in all places of employment as specified in the following paragraphs. (35-4.b)

35-5. Inspection Requirements.

a. Inspect all USACE-operated food service facilities and facilities operated under USACE contracts, including galleys aboard vessels, according to TB MED 530 and the USPHS Food Code. (35-5.a)

b. High Risk Facilities. Periodic sanitation inspections of food preparation areas of high risk facilities must be conducted and documented according to TB MED 530 table 8-2, at least quarterly. (35-5.b)

35-6. Activity Hazard Analysis (AHA) Requirements.

Develop AHAs according to paragraphs 1-6 or 2-6, as applicable.

35-7. Minimum Plan Requirements.

a. Housekeeping Plan. A written housekeeping plan or program is required when toxic dusts, fumes, or mists are generated and must include the following elements: (35-7.a)

(1) Detailed description of the activity being performed.

(2) Description of anticipated hazards or concerns and the control measures that will be implemented to control to an acceptable level.

(3) Assignment of personnel and their roles and responsibilities. Include necessary information/documentation to support qualifications/training of such persons. (See para 35-3)

(4) Routine maintenance and housekeeping procedures and schedule.

(5) Inspection and oversight methods to ensure adherence to the plan.

b. Extermination Plan. If vermin controls are implemented on a work site, a written Extermination Plan is required (for example, prevent the entrance or harborage

of rodents, insects, and other vermin). Written plans must be developed according to EPA's Integrated Pest Management Principles and must include the following elements: (35-7.b)

(1) Detailed description of the activity being performed.

(2) Description of anticipated hazards or concerns and the control measures that will be implemented to control to an acceptable level.

(3) Assignment of personnel and their roles and responsibilities. Include necessary information/documentation to support qualifications/training of such persons, to include proof of license/certification when necessary. (See para 35-3)

(4) Description of extermination activities to be performed, including necessary PPE and equipment needed and disposal and clean-up procedures.

(5) SDSs of products (see chapter 6).

(6) Inspection and oversight methods to ensure adherence to the plan.

35-8. General Requirements.

a. Housekeeping. Maintain places of employment as clean as possible, taking into consideration the nature of the work. Conduct regular cleaning to maintain safe and sanitary conditions in the workplace. (35-8.a)

(1) In workplaces where toxic dusts, fumes, or mists are generated, clean all surfaces in the work area and adjacent common use according to a written Housekeeping Plan based on the frequency and quantity of toxic material generation. (See para 35-7)

(2) Keep the floors of workrooms as dry as possible. Maintain drainage where wet processes are used via false floors, platforms, or mats, or provide dry standing places when possible. Utilize appropriate footwear.

(3) To facilitate cleaning, keep all floors, working places, and passageways free from protruding nails, splinters, loose boards, clutter and unnecessary holes and openings.

(4) Regularly clean and maintain in good order all washing and toilet facilities and rooms.

(5) Ice machines must be cleaned at a frequency specified by the manufacturer according to FDA Food Code 2009 chapter 4, part 602.11 section (E) items (4a and b) and NSF/ANSI 12.

b. Drinking Water. Provide an adequate supply of potable water in all places of employment for both drinking and personal hygiene. (35-8.b)

(1) Whenever possible, provide drinking water from a local municipal water supply that meets federal, state, and local drinking water standards.

(2) When drinking water is obtained from an onsite well, test the water and the supply system according to drinking water regulations (that is, 40 CFR 141-143) and any state or local drinking water regulations.

(3) If potable water is not available from a local municipal water supply or onsite well, provide a temporary potable water system from a licensed drinking water source. Purchase of specialized drinking water (for example, bottled water) with use of appropriated funds (USACE only) must be authorized.

(4) Connect construction trailers and other temporary or semi-permanent facilities to the local municipal water supply unless the remoteness of the location makes this prohibitive. See chapter 4 for Temporary Facilities and chapter 11 for NEC standards related to bonding requirements. When unable to connect to the municipal supply, utilize temporary potable water systems and the services provided by a licensed potable water contractor.

(5) Outside the Continental United States, provide drinking water at military fixed facilities in compliance with country-specific Final Governing Standards. Additionally, conduct sanitary control and surveillance of water supplies and chlorination and fluoridation according to applicable DoD Component guidelines, or if more stringent, the host nation requirements.

(6) Provide reasonably cool, 50°F to 60°F (10°C to 15.6°C), drinking water during hot weather.

(7) Use only approved potable water systems for the distribution of drinking water. Do not use “reclaimed water” (treated wastewater) in potable systems.

(8) Design, construct, operate and maintain portable drinking water dispensers to ensure sanitary conditions. Portable drinking water dispensers must be capable of being closed and must have a tap. Mark containers used to distribute drinking water with “DRINKING WATER” and do not use for any other purpose. Dispense drinking water by means that prevent contamination between the consumer and the source.

(9) All fountain dispensers must have a guarded orifice.

(10) Portable water coolers, dispensers, or containers will be supplied with single-use disposable cups in a sanitary container attached to or nearby the dispenser body and a waste receptacle for used cups adjacent to the dispenser. Single-use disposable cups or individual refillable containers must be used when drinking from water coolers

or containers. Do not use a common cup or other common utensils (shared by more than one person).

(11) Do not use potable drinking water dispensers to store or cool drinks or food or other items; they may only contain drinking water.

(12) Do not use open containers (for example, barrels, pails, or tanks), or any container (with or without a fitted cover) from which the water is dipped or poured for drinking water. A lid must remain on the container except when being sanitized, washed, or filled.

(13) All potable wells intended for drinking water or human contact must include appropriate wellhead protection to ensure sanitary quality. Wellhead protection includes methods or accessories to prevent fecal matter contamination, insect infestation, and deliberate human actions that might jeopardize the quantity and quality of the water supply.

c. Non-Potable Water. (35-8.c)

(1) Conspicuously mark outlets dispensing non-potable water "CAUTION WATER UNSAFE FOR DRINKING, WASHING, OR COOKING." Outlets dispensing non-potable water into dumping stations at USACE managed campgrounds may, in lieu of this requirement, be posted according to EP 310-1-6A and EP 310-1-6B.

(2) There must not be any cross-connection, open or potential, between a system furnishing potable water and a system furnishing non-potable water.

(3) Non-potable water may be used for cleaning work areas, except food processing and preparation areas and personal service rooms, provided this non-potable water does not contain concentrations of chemicals, fecal coliform, or other substances which could create unsanitary conditions or be harmful to employees.

d. Toilet Facilities. Provide toilet facilities in all places of employment according to the following requirements. For construction sites, see paragraph 35-8.d(2). (35-8.d)

(1) General. The requirements below do not apply to mobile crews or to normally unattended work locations if employees working at these locations have transportation readily available to nearby facilities which meet the other requirements of paragraph 35-8.d.

(a) Provide separate toilet rooms and facilities for each sex (see table 35-1). Separate toilet rooms for each sex need not be provided if toilet rooms can only be occupied by one person at a time, can be locked from the inside, and contain at least one toilet seat. Where such single-occupancy toilet rooms have more than one toilet facility, only one toilet facility in each toilet room may be counted.

(b) Provide an adequate supply of toilet paper and a toilet paper holder (roller) for each seat.

(c) When more than one toilet is present in a toilet room, provide each toilet with an individual compartment equipped with a door and separated from other toilets by walls or partitions sufficiently high to ensure privacy.

(d) Provide adequate interior lighting (see chapter 7).

(e) Equip each toilet with a toilet seat and toilet seat cover.

(f) Provide adequate ventilation. Screen all windows and vents and vent seat boxes to the outside minimum vent size 4 inches (10.2 cm) with vent intake located 1 inch (2.5 cm) below the seat.

(g) Extreme Temperatures. Maintain adequate temperatures within toilet rooms to prevent damage to facilities and components and minimize thermal stressors to personnel (see chapter 6).

(2) Construction Sites. Provide toilet facilities on construction sites. The requirements of paragraph 35-8.d do not apply to mobile crews or to normally unattended work locations if employees working at these locations have transportation immediately available to nearby toilet facilities that meet the other requirements of this paragraph 35-8.d.

(a) Where sanitary sewers are not available, provide jobsites with chemical toilets, re-circulating toilets, or combustion toilets, unless prohibited by state or local codes.

(b) Equip each toilet with a toilet seat and toilet seat cover.

(c) Each toilet facility, except those specifically designed and designated for females, must be equipped with a metal, plastic, or porcelain urinal trough (see table 35-2).

(d) Provide an adequate supply of toilet paper and a toilet paper holder (roller) for each seat.

(e) Provide separate toilet rooms and facilities for each sex (see table 35-2). Separate toilet rooms for each sex need not be provided if toilet rooms can only be occupied by one person at a time, can be locked from the inside, and contain at least one toilet seat.

(f) Construct toilet facilities so that the occupants are protected against weather and falling objects, all cracks are sealed, and the door is tight-fitting, self-closing, and capable of being latched from the inside.

(g) Provide adequate ventilation. Screen all windows and vents and vent seat boxes to the outside (minimum vent size 4 inches (10.1 cm)) with vent intake located 1 inch (2.5 cm) below the seat.

(h) Provide adequate interior lighting (see chapter 7).

(i) Establish provisions for routinely servicing and cleaning all toilets and disposing of the sewage before placing toilet facilities into operation. Ensure sewage disposal and the placement location selected are according to applicable federal, state, and local health requirements.

(3) Provide employees working in temporary field conditions, on mobile crews, or in normally unattended work locations with at least one toilet facility, unless transportation to nearby toilet facilities is readily available.

e. Hand Washing Facilities. Provide hand washing facilities at all toilet facilities and as needed to maintain healthful and sanitary conditions. (35-8.e)

(1) Provide all hand washing facilities with water from an approved potable water supply. Water must be either hot and cold running water or tepid running water.

(2) Provide hand soap or similar cleansing agents.

(3) Provide individual disposable paper towels or warm air blowers designed for hand-drying, convenient to the washing facilities.

(4) Where it is not practical to provide running water, hand sanitizer and individual disposable paper towels may be used. Hand sanitizers must contain at least 60% ethyl alcohol as its active ingredient and workers must be instructed on proper use.

f. Washing Facilities. (35-8.f)

(1) Provide adequate washing facilities for persons engaged in application of paints, coatings, herbicides, insecticides, or other operations where contaminants may be harmful at or near the work site so that employees are able to remove such substances.

(2) Whenever showers are required by a particular standard, adhere to the following:

(a) Provide one shower for every ten employees (or fraction thereof) of each sex, who are required to shower during the same shift.

(b) Provide body soap or other appropriate cleansing agents.

(c) Provide hot and cold water from an approved potable water supply feeding a common discharge line.

(d) Provide employees who use showers individual clean towels.

g. Changing Rooms. Whenever employees are required by a particular standard to wear protective clothing, provide changing rooms with separate storage facilities for both street clothes and protective clothing. (35-8.g)

h. Laundry of Work Clothing. If non-disposable work clothing provided by the employer becomes contaminated, establish provisions to ensure clothing is laundered and decontaminated by the employee prior to reuse and prior to leaving the work site. If contaminated work clothing is taken to a commercial laundry, advise the laundry representative of the potential contaminants on the clothing. (35-8.h)

i. Food Service. (35-8.i)

(1) All USACE-operated food service facilities, including galleys aboard vessels, must maintain compliance with TB MED 530 and USPHS Food Code. All other facilities operated under USACE contracts, including galleys aboard vessels, must maintain compliance with the USPHS Food Code.

(2) Provide food that is wholesome, free from spoilage, that is processed, prepared, handled, and stored in such a manner so that it is protected against contamination.

(3) Do not consume, store food, or beverages in a toilet room or in any area exposed to a toxic material.

(4) Food handlers must meet the qualifications and training requirements as listed in paragraph 35-3.

(5) All food service facilities must be inspected according to paragraph 35-5.

j. Waste Disposal. (35-8.j)

(1) Provide an adequate number of waste receptacles in each workspace for proper disposal of materials. Receptacles must be constructed of smooth, corrosion-resistant, easily cleanable, or disposable materials, be provided with solid tight-fitting covers (for food service areas), be emptied at least daily, and be maintained in a sanitary condition.

(2) Provide receptacles used for putrescible solid or liquid waste or refuse that are constructed to prevent leakage and to allow thorough cleaning and sanitary maintenance. Such receptacles must be equipped with solid tight-fitting covers unless they can be maintained in sanitary conditions without covers.

(3) Remove all sweepings, solid or liquid wastes, refuse, and garbage in a manner which avoids creating a menace to health and discarded as often as necessary or appropriate to maintain sanitary conditions.

k. Vermin Control. (35-8.k)

(1) Construct, equip, and maintain enclosed workplaces, as practicable as possible, to prevent the entrance or harborage of rodents, insects, or other vermin.

(2) When the presence of vermin is detected, establish an Extermination Plan according to paragraph 35-7.

35-9. Figures and Tables.

**Table 35-1
Minimum Toilet Facilities (Other than Construction Sites)**

Number of Employees	Minimum Number of Toilets
1 to 15	One (1)
16 to 35	Two (2)
36 to 55	Three (3)
56 to 80	Four (4)
81 to 110	Five (5)
Number of Employees	Minimum Number of Toilets
111 to 150	Six (6)
Over 150	Refer to Note 2

Note:

¹ Where toilet facilities will not be used by women, urinals may be provided instead of toilets, except that the number of toilets in such cases must not be reduced to fewer than 2/3 of the minimum number specified.

² Add one additional toilet fixture for each additional 40 employees.

**Table 35-2
Minimum Toilet Facilities (Construction Sites)**

Number of Employees	Minimum Number of Toilets
20 or fewer	One (1)
20 or greater	One (1) toilet seat and one (1) urinal per 40 workers.
200 or greater	One (1) toilet seat and one (1) urinal per 50 workers.

Note:

Where toilet facilities will not be used by women, urinals may be provided instead of toilets, except that the number of toilets in such cases must not be reduced to fewer than 2/3 of the minimum number specified.

35-10. Checklists and Forms.

Not Applicable.

Chapter 36 Hazardous Waste Operations and Emergency Response

36-1. References.

- a. ANSI/ASSP Z490.1, Criteria for Accepted Practices in Safety, Health and Environmental Training (<https://webstore.ansi.org/>) (36-1.a)
- b. EM 385-1-97, Explosives – Safety and Health Requirements Manual (<https://www.publications.usace.army.mil/USACE-Publications/Engineer-Manuals/>) (36-1.b)
- c. EP 415-1-266, Construction – Resident Engineer Management Guide for Hazardous, Toxic, and Radioactive Waste Projects (<https://www.publications.usace.army.mil/USACE-Publications/Engineer-Pamphlets/>) (36-1.c)
- d. ER 200-2-3, Environmental Compliance Policies (<https://www.publications.usace.army.mil/USACE-Publications/Engineer-Regulations/>) (36-1.d)
- e. ER 385-1-40, Occupational Health Program (<https://www.publications.usace.army.mil/USACE-Publications/Engineer-Regulations/>) (36-1.e)
- f. ER 385-1-92, Safety and Occupational Health Requirements for Environmental Cleanup Projects (<https://www.publications.usace.army.mil/USACE-Publications/Engineer-Regulations/>) (36-1.f)
- g. 29 CFR 1910.38, Emergency Action Plans (<https://www.govinfo.gov/content/pkg/CFR-2020-title29-vol5/pdf/CFR-2020-title29-vol5-sec1910-38.pdf>) (36-1.g)
- h. 29 CFR 1910.120, Hazardous Waste Operations and Emergency Response (<https://www.govinfo.gov/content/pkg/CFR-2020-title29-vol5/pdf/CFR-2020-title29-vol5-sec1910-120.pdf>) (36-1.h)
- i. 29 CFR 1910.1200, Hazard Communication (<https://www.govinfo.gov/content/pkg/CFR-2020-title29-vol6/pdf/CFR-2020-title29-vol6-sec1910-1200.pdf>) (36-1.i)
- j. 29 CFR 1926.35, Employee Emergency Action Plan (<https://www.govinfo.gov/content/pkg/CFR-2020-title29-vol8/pdf/CFR-2020-title29-vol8-sec1926-35.pdf>) (36-1.j)

k. 29 CFR 1926.65, Hazardous Waste Operations and Emergency Response (<https://www.govinfo.gov/content/pkg/CFR-2020-title29-vol8/pdf/CFR-2020-title29-vol8-sec1926-65.pdf>) (36-1.k)

36-2. Definitions.

a. Contamination Reduction Zone (CRZ). The CRZ is an area on the project where personnel and equipment are decontaminated when exiting the exclusion zone (EZ) in route to the support zone. There is potential for contamination to be present in this area that can potentially expose personnel to hazardous substances and health hazards. (36-2.a)

b. Emergency Response. Emergency response or responding to emergencies means a response effort by employees from outside the immediate release area or by other designated responders (that is, mutual-aid groups, local fire departments, etc.) to an occurrence which results, or is likely to result, in an uncontrolled release of a hazardous substance. Responses to incidental releases of hazardous substances where the substance can be absorbed, neutralized, or otherwise controlled at the time of release by employees in the immediate release area, or by maintenance personnel are not considered to be emergency responses within the scope of this chapter. Responses to releases of hazardous substances where there is no potential safety or health hazard (that is, fire, explosion, or chemical exposure) are not considered to be emergency responses within the scope of this chapter. (36-2.b)

c. Environmental Cleanup and Investigation Projects. Environmental Cleanup and Investigation Projects are sites and activities specified in 29 CFR 1910.120(a)(1) or 29 CFR 1926.65(a)(1) and involve operations where hazardous substances are investigated, removed, contained, incinerated, treated, neutralized, cleaned-up, or in any other manner processed or handled with the goal of making the site safer for people or the environment. (36-2.c)

d. Exclusion Zone (EZ). The EZ is an area known or suspected to be contaminated. This is an area where site characterization activities and contamination removal activities will take place. Work conducted in this area may have the potential to expose personnel to occupational health hazards from contamination. (36-2.d)

e. General Site Workers. General site workers are engaged directly in the hazardous substance investigation and/or removal and remediation activities. General site workers conduct investigation or cleanup activities in the EZ or CRZ and have the potential to be exposed to contamination while performing work activities. (36-2.e)

f. Health Hazard. Health hazard means a chemical or a pathogen where acute or chronic health effects may occur in exposed employees. It also includes stress due to temperature extremes and other physical agents. The term health hazard includes chemicals that are classified according to 29 CFR 1910.1200, as posing one of the following hazardous effects: acute toxicity (any route of exposure); skin corrosion or

irritation; serious eye damage or eye irritation; respiratory or skin sensitization; germ cell mutagenicity; carcinogenicity; reproductive toxicity; specific target organ toxicity (single or repeated exposure); aspiration toxicity; or simple asphyxiant. (36-2.f)

g. Hazardous Substance. Hazardous substance means any substance designated or listed as hazardous substance or hazardous waste as defined in 29 CFR 1910.120(a)(3) or 29 CFR 1926.65(a)(3), where exposure to which results or may result in adverse effects on the health or safety of employees during the performance of their duties. (36-2.g)

h. Other Site Workers. Other site workers are those regularly onsite who work in areas which have been monitored and fully characterized indicating that exposures are under permissible exposure limits and published OELs where respirators are not necessary, and the characterization indicates that there are no health hazards or the possibility of an emergency developing. (36-2.h)

i. Post Emergency Response. The portion of an emergency response performed after the immediate threat of a release has been stabilized or eliminated and clean-up of the site has begun. If post emergency response is performed by an employer's own employees who were part of the initial emergency response, it is considered to be part of the initial response and not post emergency response. However, if a group of an employer's own employees, separate from the group providing initial response, performs the clean-up operation, then the separate group of employees would be considered to be performing post-emergency response and subject to 29 CFR 1910.120(q)(11) or 29 CFR 1926.65(q)(11). (36-2.i)

j. Supervisors. Supervisors are individuals that provide onsite management and are directly responsible for employees engaged in hazardous waste cleanup and investigation operations. (36-2.j)

k. Support Zone. The support zone is an area that is not and will not become contaminated because of investigation or cleanup activities. This is an area that borders the CRZ and where administrative and other support personnel remain to regulate and oversee the activities happening in the other work zones and the operation at large. This area is not anticipated to be contaminated and does not have the potential cause exposure to support zone personnel from contamination in the CRZ or EZ. (36-2.k)

36-3. Personnel Required Qualification/Training.

a. Training. At a minimum, train workers entering the CRZ and the EZ at an environmental cleanup and investigation project and their supervisors according to the training requirements of 29 CFR 1910.120(e)/ 29 CFR 1926.65(e). For USACE personnel performing environmental cleanup operations, document exposure to hazardous substances as part of duties on the employee's PHA. Specify safety-related

training requirements per this paragraph on the employee PHA. Supervisors and employees must review the PHA annually and when duties change. See chapter 1 for PHAs. (36-3.a)

(1) Initial Training. Initial training must meet the requirements described below:

(a) General site workers must receive a minimum of 40 hours of instruction off the project site and a minimum of three days actual field experience under the direct supervision of a trained experienced supervisor prior to being assigned to perform their duties.

(b) Other site workers must receive a minimum of 24 hours of instruction off the project site, and a minimum of one day of actual field experience under the direct supervision of a trained, experienced supervisor.

(c) Workers with 24 hours of training as described in paragraph 36-3.a(1)(b) of this chapter, and who become general site workers, must have the additional 16 hours of instructions off the project site and two days of on the job training necessary to total the training specified in paragraph 36-3.a(1)(a).

(2) Supervisors must receive training according to paragraph 36-3.a(1)(a). Supervisory training may be reduced to 24 hours and one day of supervised field experience if they are only responsible for supervising other site workers according to paragraph 36-3.a(1)(b). All supervisors must have at least eight additional hours of specialized training at the time of job assignment on such topics as, but not limited to, the employer's SOH program and the associated employee training program, PPE program, spill containment program, record keeping requirements, and health hazard monitoring procedure and techniques.

(3) Refresher Training. All site workers and supervisors participating in the training program in paragraph 36-3.a(1) must attend an annual 8-hour refresher training that meets the requirements of 29 CFR 1910.120(e)(8) or 29 CFR 1926.65(e)(8). The refresher training must cover some of the topics from the initial course in a manner relevant to organizational operations, it must address hazards that were encountered the previous year that can serve as training examples of related work, and other relevant safety and health topics.

(4) Equivalent training is allowed when it can be shown in writing that employee knowledge and experience is equivalent to 40-hour or 24-hour initial and refresher training requirements and objectives. Equivalent training must be certified in writing by the employer.

(5) Instructor Qualifications. Training instructor qualifications must meet the requirements in 29 CFR 1910.120(e)(5) or 29 CFR 1926.65(e)(5).

(a) Personnel responsible for planning and teaching the initial and refresher training course must be thoroughly knowledgeable about the subject matter that is being presented in the training.

(b) Trainers must possess the knowledge and experience to instruct on each of the topics.

(c) Trainers must retain qualifications for teaching subject matter by regularly attending and participating in formal industrial hygiene or safety related courses, and conferences.

(d) Trainers must meet the requirements according to ANSI Z490.1 and have successfully completed a "train-the-trainer" program or must otherwise have the academic credentials and instructional experience necessary to teach the topics that directly apply to hazardous waste cleanup and investigation operations.

(6) Site-Specific Training. All site workers must receive site-specific training. Site specific training must cover the Site Safety and Health Plan (SSHP) and how the SSHP applies to the activities that are to be performed. Site specific training must be provided before onsite work begins and include training topics specific to other chapters of this manual as they apply to the work activities performed, other occupational health standards applicable to the planned site work and operations, and site-specific hazards relevant to onsite contamination. When relevant, assure that workers are made aware of contaminant-related hazards by use of a site-specific map.

(7) Computer-Based Interactive Training: Computer-based interactive training is acceptable provided it meets the following criteria:

(a) The course covers the requirements in 29 CFR 1910.120(e) or 29 CFR 1926.65(e).

(b) Students must be able to ask questions and receive answers in a timely manner from qualified instructors that meet the requirements in 36.a(5).

(c) Students must participate in 16-hours of hands-on exercises to demonstrate equipment use and procedural proficiency.

(8) Emergency Response. Facilities and projects using, storing, or handling hazardous substances and whose employees will be engaged in emergency response operations must receive the appropriate level of training according to 29 CFR 1910.120(q)(6) or 29 CFR 1926.65(q)(6). All employees who are trained according to this paragraph must receive annual refresher training according to 29 CFR 1910.120(q)(8) or 29 CFR 1926.65(q)(8).

(9) Resource Conservation and Recovery Act (RCRA) Treatment Storage and Disposal (TSD). RCRA TSD facilities and projects that meet the requirements of 29 CFR 1910.120(a)(1)(iv) or 29 CFR 1926.65(a)(1)(iv) and must provide their workers with training according to 29 CFR 1910.120(p)(7) or 29 CFR 1926.65(p)(7).

(10) Shipping Materials. All USACE employees who prepare DOT shipping papers (including hazardous waste manifests), label, package and/or mark containers for purposes of transportation must receive DOT and DoD training. Training must be documented, and employees issued an appointment letter by their commander. Training must meet the requirements of ER 200-2-3 and EP 415-1-266.

b. Medical Surveillance Program for Environmental Cleanup and Investigation Activities. Medical surveillance must be performed according to 29 CFR 1910.120(f) or 29 CFR 1926.65(f). (36-3.b)

(1) At a minimum, employees who are anticipated to enter the CRZ or EZ more than 30 times a year must be enrolled in medical surveillance. For employees that enter the CRZ or EZ less than 30 times per year or where the duration is difficult to anticipate, enrollment in medical surveillance is the discretion of the employer based on evaluation of the employee's activities at the project and the need to enter the CRZ or EZ.

(2) Medical surveillance examination must be provided at the following frequencies:

- (a) Prior to being assigned to hazardous waste cleanup operations.
- (b) Annually while working in the cleanup program.
- (c) When signs or symptoms of exposure to contamination are experienced.
- (d) At termination of employment or reassignment to work activities outside the environmental cleanup program.

(3) Retain certification of medical clearance for all personnel and make available only upon request.

(4) USACE personnel must also comply with the medical surveillance requirements according to ER 385-1-40. An evaluation must be performed by the employee's supervisor with support from their SOHO and documented in the employee's PHA. See chapter 1 for PHAs.

c. USACE Project Safety and Health Manager (PSHM). Depending on the primary contaminant of concern involved in the investigation/ cleanup activities, the PSHM must belong to the occupational series specified in ER 385-1-92. The PSHM

must possess at least three years of experience implementing occupational health and safety protection requirements on hazardous waste investigation and cleanup projects. (36-3.c)

d. Contractor Safety and Health Manager (SHM). Depending on the contamination to be impacted by investigation and cleanup activities, the SHM must possess professional certification as a CIH, Certified Health Physicist or Certified Safety Professional and have at least three years of experience implementing occupational health and safety protection requirements at environmental cleanup projects. The SHM must have in-depth knowledge of the employer's health and safety program and have access to senior leaders within their organization structure. (36-3.d)

e. Site Safety and Health Officer (SSHO). The SSHO must meet the initial, refresher, and supervisor training according to paragraph 36-3.a of this manual. The SSHO must also possess the training and experience outlined for a SSHO according to chapter 2 of this manual. SSHOs experience required by chapter 2 must include at least one year of experience with implementing SOH requirements on hazardous waste investigation and cleanup projects. The SSHO must have the training and experience to conduct exposure monitoring, sampling, and selecting/adjusting controls. (36-3.e)

36-4. Roles and Responsibilities.

a. USACE PSHM. A USACE PSHM must be assigned to environmental cleanup and investigation projects where development, review, and implementation of a SSHP is required (see para 36-7.a). The PSHM must enlist the support of the local SOHO with appropriate education and experience when working on sites with multiple hazards (for example, construction safety, life safety, chemical, explosives, ionizing radiation). For environmental cleanup and investigation activities solely performed by USACE personnel, the PSHM responsibilities are consistent with the requirements of the SHM in paragraph 36-4.b(1). (36-4.a)

b. Contractor SHM. Contractors must assign a SHM to all environmental cleanup and investigation projects. The SHM must enlist the support of SOH professionals with appropriate training and experience when working on sites with contamination hazards outside their area of expertise. The SHM is responsible for the following: (36-4.b)

(1) Developing, reviewing, and overseeing implementation of the SSHP for their organization.

(2) Providing technical and management support to the SSHO.

(3) Evaluating occupational exposure monitoring/air sampling data and adjusting SSHP requirements as necessary.

(4) Certifying that all personnel comply with training and medical surveillance qualification requirements defined in paragraph 36-3 of this manual.

- (5) Visiting projects to audit the effectiveness of the SSHP.
- (6) Remaining available for project emergencies.
- (7) Developing modification to the SSHP as needed.
- (8) Serving as a QC staff member.
- (9) Approving the SSHP by signature.

c. Site Safety and Health Officer (SSHO). An SSHO must be assigned to all environmental cleanup and investigation projects. The SSHO is responsible for the following: (36-4.c)

(1) Being present anytime investigation or cleanup operations are actively being performed to implement the SSHP.

(2) Inspecting site activities to identify SOH deficiencies and correct them.

(3) Coordinating changes/modifications to the SSHP with the SHM and site superintendent, PM, and KO or COR.

(4) Conducting exposure monitoring and sampling and adjusting protective equipment with the concurrence of the SHM.

(5) Conducting project-specific training.

(6) Participating in the preparation of the SSHP.

(7) Ensuring that site-specific emergency procedures are developed and rehearsed with site workers and local emergency response organizations.

(8) Should any unforeseen hazard become evident during the performance of work, the SSHO will bring such hazard information to the attention of the SHM and the KO or COR (both verbally and in writing) for resolution as soon as possible. In the interim, necessary action must be taken to reestablish and maintain safe working conditions.

d. Emergency Response Teams. The Emergency Response Team at facilities or projects that store, use, and handle hazardous substances must, at a minimum, respond in a defensive manner to hazardous substance releases at the facility or construction project. The team must use the equipment and procedures specified in the emergency response plan for a defensive response. The Emergency Response Team will only provide response services beyond defensive if qualified and only according to the procedures specified in the facility or construction project-specific Emergency Response Plan. (36-4.d)

36-5. Inspection Requirements.

Inspection must be performed by the SSHO and include qualitative and/or quantitative assessments to ensure the following:

- a. The support zone, CRZ and EZ are defined and effective. (36-5.a)
- b. Exposure controls to include PPE are effective. (36-5.b)
- c. Decontamination procedures are being implemented and effective. (36-5.c)
- d. Occupational exposure sampling and monitoring equipment is being used properly and monitoring results documented. (36-5.d)
- e. Emergency response services have been arranged and rehearsed with local emergency response service providers. (36-5.e)

36-6. Activity Hazard Analysis (AHA) Requirements.

Develop AHAs according to paragraphs 1-6 or 2-6, as applicable. AHAs for environmental cleanup and investigation projects must be developed in consultation with the SSHO and include the following:

- a. Identify the likely hazards and contamination exposure routes for the work activities being performed during each job step. (36-6.a)
- b. Provide the exposure controls that will eliminate or minimize worker exposure to contamination as they relate to each of the job steps within the activity. (36-6.b)

36-7. Minimum Plan Requirements.

a. Site Safety and Health Plan (SSHP). A SSHP must be developed for all environmental cleanup and investigation projects. The SSHP must address the SOH hazards of each phase of site operation and include the requirements and procedures for employee protection. The SSHP must specifically address the requirements to protect workers from the health hazards associated with site contamination and the specific processes that may disturb, release, and/or transport these contaminants during the planned investigation or remedial action activities. See chapter 6 of this manual for radiation safety requirements to be included in the SSHP for cleanup of radioactive isotopes. Changes and modification to the SSHP are permitted and must be made in writing with the concurrence of the SHM and approved by the USACE supervisor or accepted by the KO or COR. The SSHP must be developed according to 29 CFR 1910.120(b)(4)/ 29 CFR 1926.65(b)(4) and as described below. The SSHP must include the following: (36-7.a)

(1) Site Description and Contamination Characterization. A description of the site, location and approximate size, description of activities to be performed, duration of the planned activity, site topography and accessibility (air and road), pathways of hazardous

substance dispersion. A description of the contamination based on the information or data obtained from site characterization and analysis activities performed according to 29 CFR 1910.120(c)/ 29 CFR 1926.65(c).

(2) Staff organization, qualifications, and responsibilities (see para 36-4).

(3) Type and frequency of required training, both general and project specific (see para 36-3).

(4) Hazard Evaluation. Detailed evaluation of the hazards related to the contamination expected to be encountered, OEL, exposure route, exposure symptoms, health effects, odor and if available odor threshold, and target organs. Provide the determination of the potential exposure levels and routes based on sampling data and/or the composition of the substance, work process, exposure controls, type of media, and routes of exposure.

(5) Occupational Exposure Controls. Detail the controls that will be implemented to protect workers from exposure to contamination. Detail any hazard elimination/substitution steps, engineering and administrative controls, and PPE that will be utilized, see chapter 5 for PPE requirements. Identify the frequency of inspections for controls and the personnel responsible for conducting inspections and sampling/monitoring.

(6) Risk Analysis. The risk analysis must evaluate the overall risk for the planned environmental cleanup or investigation project and how planned exposure controls, and the work process will eliminate or reduce the likelihood for exposure to contaminants during each site task and activity.

(7) Occupational Exposure Sampling and Monitoring Procedures. Detail the occupational exposure sampling and monitoring to be implemented to ensure measures to protect workers from overexposure to site contaminants are adequate and effective. This must include frequency and types of air monitoring, personnel monitoring, and environmental sampling techniques and instrumentation to be used, including methods of maintenance and calibration of monitoring and sampling equipment to be used. Include project specific action levels and exposure mitigation measures to be taken if action levels are exceeded. Detail how these records will be maintained and managed.

(8) Medical Surveillance. Summarize the medical surveillance provided to employees on this project and how these records will be maintained and managed (see para 36-3.b).

Note. Do not include medical clearance certificates or medical documents containing PII, PHI or other protected information in the SSHP. Provide a summary of personnel with date of last medical clearance and the applicable standard.

(9) Thermal Stress Management Plan. Detail the procedures and practices that will be implemented to protect and monitor workers from heat and cold stress during the performance of the environmental cleanup and investigation project. See chapter 6 for Thermal Stress Management Plan requirements.

(10) SOPs, engineering controls, and work practices to include the following:

(a) Site rules/prohibitions (for example, buddy system, eating/drinking/ smoking restrictions.).

(b) Work permit requirements (for example, radioactive work, excavation, hot work, confined space).

(c) Material handling procedures (for example, soil, liquid, radioactive materials, spill contingency).

(d) Drum/container/tank handling (for example, opening, sampling, overpacking, draining, pumping, purging, inerting, cleaning, excavating and removal, disassembly and disposal, spill contingency).

(11) Site Control Measures. Describe how the site will be set up so that access into and out of the EZ through the CRZ will be controlled. Define how work activities inside the EZ will be conducted to prevent spread contamination to uncontaminated areas of the project.

(12) Personal Hygiene and Decontamination Procedures. Describe equipment to be used and step-by-step procedures to be followed that will assure personnel and equipment are decontaminated properly when exiting the EZ through the CRZ and into the support zone.

(13) Emergency Response and Contingency Procedures. Document a plan for responding to emergencies at the project that meets the requirements in 29 CFR 1910.120(l) or 29 CFR 1926.65(l). Emergency response and contingency procedures must address the following:

(a) Describes the agreement that will be established between the contractor (or USACE for in-house activities), local emergency responders, and the servicing emergency medical facility. Identify the Emergency Response Team that would dispatch to the cleanup and investigation site at the time of an emergency, their contact information and capabilities. Specify the responsibilities of onsite personnel, the site configuration, specific details about site activities with emergency response personnel and the emergency medical facility in the event of an on-site emergency.

(b) Personnel and lines of authority for emergency situations.

(c) Criteria and procedures for emergency recognition and site evacuation (for example, emergency alarm systems, evacuation routes and reporting locations, site security).

(d) Decontamination and medical treatment procedures of injured personnel.

(e) A route map to emergency medical facilities and phone numbers for emergency responders.

(f) Criteria for alerting the local community responders.

(14) Confined Spaces. If confined spaces must be entered to perform cleanup work, then detail the site-specific confined space entry procedures according to chapter 34.

(15) Spill Containment. Describe equipment to be used and procedures to be followed to store contaminated media and investigative derived waste generated by cleanup activities. Identify drum and container handling procedures when applicable to the work. Include spill containment procedures to contain spills of contaminated media stored onsite.

b. Comprehensive Work Plan. A Comprehensive Work Plan is required for all environmental cleanup and investigation projects. The plan must be developed according to 29 CFR 1910.120(b)(3) or 29 CFR 19126.65(b)(3). (36-7.b)

c. Emergency Response Plan. An Emergency Response Plan is required for facilities or construction projects using, storing, or handling hazardous substances where a hazardous substance release may result in exposure causing adverse effects to the health or safety of employees. The plan must be developed according to 29 CFR 1910.120(q) or 29 CFR 1926.65(q). The Emergency Response Plan for hazardous spill Response must include the following: (36-7.c)

Note. Projects that will evacuate their employees from the danger area when an emergency occurs, and do not permit any of their employees to assist in handling the emergency or providing spill mitigation steps must instead of an Emergency Response Plan, provide an Emergency Action Plan according to 29 CFR 1910.38 or 29 CFR 1926.35.

(1) Operations. Identify operations requiring use of hazardous substances.

(2) Pre-Emergency Planning with Local Emergency Responders. Describe emergency response agreements, including roles and responsibilities, made with local emergency responders for hazardous material response, fire, rescue, emergency medical care, and security and law enforcement.

(3) Personnel Roles, Lines of Authority, Training, and Communication. Describe key personnel roles, command structure/lines of authority, and communications requirements for responding to site-specific hazardous substance releases.

(4) Emergency Recognition and Prevention. Identify the likely emergency scenarios for the project and how employees can expect to identify and recognize emergency scenarios.

(5) Safe Distances and Places of Refuge. Select safe places of refuge to be used in emergency situations, identify these locations in the Emergency Response Plan, and require employees to report to selected places of refuge during emergencies.

(6) Site Security and Control. Describe how the facility will be secured and describe access to the site controlled during emergencies.

(7) Evacuation Routes and Procedures. Describe and map out evacuation routes to safe places of refuge and any special safety and health procedures employees must follow while evacuating the facility.

(8) Decontamination. Describe site procedures for decontaminating personnel and equipment that may have come into contact with hazardous substances.

(9) Emergency Medical Treatment and First Aid. Explain how emergency medical treatment and first aid will be provided in the event of a hazardous substance spill.

(10) Emergency Alerting and Response Procedures. Describe how personnel will be alerted in the event of a hazardous substance spill, and how facility personnel must respond after emergency alerting procedures are initiated.

(11) PPE and Emergency equipment. Describe the PPE and emergency response equipment that will be available for use by response personnel at the facility.

(12) Emergency Response Team. Designate a facility-specific Emergency Response Team. Describe the team's emergency responsibilities for interacting with local emergency response providers (that is, where the facility team's responsibilities end, and the local response providers begin).

(13) Critique of Response and Follow-up. Describe how lessons learned from emergency response will be documented and used to improve future emergency response actions.

36-8. General Requirements.

a. Clean-up operations, investigations, corrective actions, voluntary clean-up operations involving employee exposure or reasonable possibility of employee exposure to safety and health hazards are required to comply with all sections of

29 CFR 1910.120 or 29 CFR 1926.65 except for sections (p) and (q) and all of parts of this chapter except for paragraph 36-7.c. (36-8.a)

b. RCRA TSD Facility Operation. Organizations operating RCRA TSD facilities are required to comply with 29 CFR 1910.120(p) or 29 CFR 1926.65(p). (36-8.b)

c. Hazardous Materials (HAZMAT) Spill Emergency Response Operations. Organizations responsible for performing HAZMAT spill emergency response operations must plan and perform responses according to their written HazCom Program (see chapter 6), site specific Emergency Action Plan in 29 CFR 1910.38, and meet the applicable requirements of 29 CFR 1910.120(q) or 29 CFR 1926.65(q). (36-8.c)

d. When employees will be engaged in emergency response operations, they must do so according to 29 CFR 1910.120 (q) or 29 CFR 1926.65(q) when a hazardous substance release and response activities may result in exposure causing adverse effects to the health or safety of employees. (36-8.d)

e. Munitions and Explosives of Concern (MEC). MECs can be UXOs, discarded military munitions or munitions constituents. Treat all MEC encountered or suspected MEC as extremely dangerous. Implement the 3R's when encountering MEC: Recognize, Retreat, Report. If MEC is suspected or encountered follow the requirements according to EM 385-1-97. (36-8.e)

36-9. Figures and Tables.

Not Applicable.

36-10. Checklists and Forms.

Compliance Checklist.

Note. This checklist is optional and is intended to guide QC representatives in determining compliance with the most significant elements of this chapter.

Yes/No	Compliance Item
	SSHP is developed, has been reviewed, and approved by a PSHM or SHM, and is applicable to project specific cleanup or investigation activities.
	Site and contamination specific exposure control procedures are included in the AHA.
	PSHM/SHM verified training and medical surveillance certification of workers in the CRZ and EZ.
	Verify SHM and SSHO participation with SSHP development and implementation.
	Verify trained and experienced SSHO is onsite during cleanup or investigation activities
	Assure occupational exposure sampling and monitoring is conducted according to the SSHP.
	Assure occupational exposure controls are implemented according to the SSHP.
	Assure personal protective equipment is being used properly and is appropriate for site specific contamination.
	Verify that non-disposable personal protective equipment is cleaned and stored properly.
	Verify decontamination procedures are effectively removing contamination from equipment and personnel.
	Verify that emergency response is planned, coordinated, and rehearsed with local emergency responders.

Chapter 37 Emergency Operations

37-1. References.

- a. ANSI/ASSP A10.34, Protection of the Public on or Adjacent to Construction Sites (<https://webstore.ansi.org/>) (37-1.a)
- b. ANSI/National Electrical Manufacturers Association (NEMA) Z535, Safety Alerting Standards (<https://webstore.ansi.org/>) (37-1.b)
- c. ASTM C825, Standard Specification for Precast Concrete Barriers (<https://www.astm.org/Standard/standards-and-publications.html>) (37-1.c)
- d. ASTM F2413, Standard Specification for Performance Requirements for Protective (Safety) Toe Cap Footwear (<https://www.astm.org/products-services/standards-and-publications.html>) (37-1.d)
- e. Department of Transportation (DOT) Federal Highway Administration's "Manual on Uniform Traffic Control Devices" (MUTCD) (<https://mutcd.fhwa.dot.gov>) (37-1.e)
- f. EP 310-1-6a, Sign Standards Manual, Vol 1 (<https://www.publications.usace.army.mil/USACE-Publications/Engineer-Pamphlets/>) (37-1.f)
- g. ER 11-1-320, Civil Works Emergency Management Programs (<https://www.publications.usace.army.mil/USACE-Publications/Engineer-Regulations/>) (37-1.g)
- h. ER 500-1-1, Emergency Employment of Army and Other Resources - Civil Emergency Management Program (<https://www.publications.usace.army.mil/USACE-Publications/Engineer-Regulations/>) (37-1.h)
- i. ER 500-1-28, Emergency Employment of Army and Other Resources - National Response Planning Guide (<https://www.publications.usace.army.mil/USACE-Publications/Engineer-Regulations/>) (37-1.i)
- j. FAR Clause 52.236-13, Accident Prevention (<https://www.govinfo.gov/content/pkg/CFR-2020-title48-vol2/pdf/CFR-2020-title48-vol2-chap1-subchapH.pdf>) (37-1.j)
- k. National Safety Council (NSC), Work Zone Safety Training (<https://www.nsc.org/safety-training/workplace/work-zone-safety>) (37-1.k)
- l. 29 CFR 1910, Occupational Safety and Health Standards (<https://www.govinfo.gov/app/collection/cfr>) (37-1.l)

m. 29 CFR 1926, Safety and Health Regulations for Construction (<https://www.govinfo.gov/app/collection/cfr>) (37-1.m)

n. 44 CFR, Emergency Management and Assistance (<https://www.govinfo.gov/content/pkg/CFR-2019-title44-vol1/pdf/CFR-2019-title44-vol1.pdf>) (37-1.n)

37-2. Definitions.

a. Air Curtain Incinerator. An incinerator that operates by forcefully projecting a curtain of air across an open chamber or pit in which burning occurs. (37-2.a)

b. ENGLink. Online system that USACE uses to track commodities, mission status, and manage deployments. Through ENGLink, team members can report in real time activities that are occurring, commodities being used or installed, personnel needs, and the amount of commodities needed. (37-2.b)

37-3. Personnel Required Qualification/Training.

a. All Government employees reporting for emergency recovery operations must meet the medical requirements in the operation plan 2023-11 USACE Response to All Hazards Events (or the most current version) and must have a current medical clearance in ENGLink prior to deploying. (37-3.a)

(1) Employees with known pre-existing non-work-related medical conditions (for example, uncontrolled diabetes, cardiovascular or pulmonary problems, back conditions, pregnancy, or hypertension) may not deploy to emergency operations sites unless specific medical clearance is provided. The USACE medical provider, in conjunction with the employee's personal physician(s), must indicate their current medical condition will not jeopardize their health or their ability to fully perform their duty assignments at deployment sites.

(2) Employees may be returned to their duty station if they experience health problems that may endanger their well-being during deployment.

(3) Employees will be notified that pharmacies and medical services may be limited at the emergency operations site.

(4) USACE personnel must be provided with or obtain the immunizations as required by the current All Hazards OPOD prior to deployment. All immunization data must be updated in ENGLink. Follow-up immunizations are the responsibility of each employee's home duty station.

b. Safety Orientation. Conduct SOH in-briefings and orientation as personnel arrive at the emergency area and prior to beginning work activities. (37-3.b)

c. Traffic Control. Flaggers must be trained according to the MUTCD and applicable state DOT requirements before being placed in traffic, unless the state requirements are waived for the emergency. If waived, training and certification, such as the NSC Work Zone Safety Training, is recommended. (37-3.c)

d. Health Hazards. Employee must be trained on any health hazards (for example, asbestos, lead paint, radiation, hazardous chemicals) specifically identified by an IH or other QP according to the level of exposure to such hazards according to 29 CFR 1910 and 29 CFR 1926. This applies to both USACE and contractor personnel. See paragraph 37-8.n and chapter 6 for additional information. (37-3.d)

37-4. Roles and Responsibilities.

a. SOH Managers. (37-4.a)

(1) The SOH Manager of the district with the geographical responsibility for the emergency response will immediately be alerted of disasters and included in the planning and execution of response and recovery efforts.

(2) The SOH Manger will immediately alert the National SOH Emergency Response Program Manager of all disasters and include them in the planning and execution of response and recovery efforts.

(3) The SOH Manager will assess SOH issues and assure precautions are taken prior to deployment of personnel. Issues to consider include sanitation, drinking water, power supply, living quarters, driving conditions, environmental conditions, and health issues.

(4) The SOH Manager will manage safety and health aspects of emergency operations, provide advice on SOH issues, and provide SOH technical oversight for USACE employees, other federal employees engaged in fulfilling the USACE mission, and quality assurance for contractor employees.

b. Prime contractors. (37-4.b)

(1) Prime contractors will have as a minimum a full-time, qualified SOH professional onsite. Provide the qualifications of the SOH professional to the KO or COR for review and acceptance. Additional contractor personnel may be required as determined by the KO or COR.

(2) For debris reduction, the contractor must notify the local fire department and arrange for fire suppression support in case of fire beyond the contractor's firefighting capability.

37-5. Inspection Requirements.

a. All applicable inspections identified in other chapters of this manual are still applicable for emergency operations mission assignments. This includes, but is not limited to, flood-fighting and Federal Emergency Management Agency missions assigned to USACE. (37-5.a)

b. All incinerator placements must be inspected by a USACE SOH professional prior to the start of burning (see para 37-8.i). (37-5.b)

37-6. Activity Hazard Analysis (AHA) Requirements.

Develop AHAs according to paragraphs 1-6 or 2-6, as applicable. When construction vehicles and all vehicles exceeding 1-1/2 tons (1.4 metric tons) are required to back-up during operations, all potential hazards and controls to include the use of a spotter will be included in the AHA for the task.

37-7. Minimum Plan Requirements.

a. Accident Prevention Plan (APP). Develop and submit APPs according to chapter 2. (37-7.a)

b. Demolition Plans. For structural demolition activities, like-structures may be combined under a common engineering survey and demolition plan (see chapter 17). (37-7.b)

(1) Single-story residential structures that would pose no hazards to neighboring structures or personnel may be demolished using a common engineering survey and demolition plan.

(2) Multiple-story structures or others that could pose risks to personnel or other structures would have individual surveys and plans.

37-8. General Requirements.

a. All applicable requirements identified in other chapters of this manual are still applicable to emergency operations missions unless otherwise stated in this chapter. (37-8.a)

b. SOH Requirements. During emergency operations, it is extremely important to implement the SOH requirements. Personnel often perform unusual, difficult, or hazardous tasks while in a challenging environment, and these conditions may increase risk and the potential for accidents. Additionally, resources are in short supply, and the loss of any resource to an accident reduces the USACE ability to respond. (37-8.b)

(1) The SOH of USACE employees, contractors, and members of the public exposed to USACE activities is a primary concern during all USACE emergency

operations. SOHOs must provide the necessary input to their emergency management counterparts to ensure planning for SOH concerns, including hazard and risk analysis, is addressed prior to and during emergency operations.

(2) Contract Requirements. Include SOH program requirements in all Government and contract operations. Include FAR clause CFR 52.236-13 in contracts and memoranda of agreement/understanding for emergency operations and recovery assistance.

c. Staffing. Temporarily staff the SOHO in the Geographic District experiencing the disaster with additional safety, industrial hygiene, and medical personnel, as necessary to ensure a comprehensive SOH program is administered for all emergency operations. If a Recovery Field Office (RFO) is established, SOH staffing is usually accomplished by use of SOH functional planning and response team. If a RFO is not established, the Geographic District must establish an emergency operations SOHO (minimum staffing to include a safety manager) dedicated totally to emergency operations. Also, each Emergency Field Office must have a minimum of one SOH professional. (37-8.c)

d. Personal Protective Equipment (PPE) (Minimum Requirements for Field Work). For fieldwork (for example, construction sites, industrial operations and maintenance activities, emergency operations, regulatory inspections), minimum requirements include the following: (37-8.d)

(1) Short sleeve shirt.

(2) Long pants (excessively long or baggy pants are prohibited).

(3) Protective footwear meeting ASTM F2413 standards.

(4) All personnel working in debris collection/reduction areas must also wear hard hat, safety glasses, Class II (minimum) high-visibility vest, and have hearing protection available.

Note. Additional PPE that may be necessary must be provided at the emergency operations site and addressed in the site-specific AHA (see chapter 5).

e. Communications. (37-8.e)

(1) Use two-way radios, cellular phones, and computers, as needed, to establish and enhance communications.

(2) Communicate SOH program documents, signs, tags, instructions, etc., to employees and the public in a language they understand.

f. Duty Schedule. (37-8.f)

(1) During the first two weeks of an emergency response operation, extended work hours are allowed. Supervisors must monitor employees for signs of stress-related health problems and seek medical assistance as appropriate.

(2) For operations lasting longer than two weeks, USACE and contractor employees must not work more than 84 hours per week. Employees may be required to work up to 12 hours per day, 7 days a week. Work and travel time must allow for 8 hours continuous rest between each work shift.

(3) Employees who are working 12 hours per day, 7 days a week will be provided the opportunity for 24 hours of rest after working 14 days; and 48 hours of rest after working 21 days. Employees should take at least 24 hours off for rest after a continuous 30-day period of work and at least 24 hours every 2 weeks thereafter. Supervisors will monitor employees for signs of stress-related health problems and seek medical assistance as appropriate.

(4) All days of rest must be scheduled on a non-scheduled workday; there are no exceptions. A non-scheduled workday is a day without regularly scheduled work hours. It must be a day where only overtime is scheduled. This includes Saturdays, Sundays, or Federal Holidays. Tour of duty schedules cannot be changed to accommodate a day of rest to be taken when the employee would have otherwise been set to work regularly scheduled work hours.

g. Machinery and Mechanized Equipment (see chapters 16 and 18). (37-8.g)

(1) Inspection of equipment is critical, as the notice to mobilize can be extremely short and equipment may not be up to USACE safety standards. Whenever feasible, contract specifications must provide adequate mobilization time to allow equipment to be inspected and brought up to USACE standards. Do not use equipment not meeting the requirements of this manual.

(2) Trucks hauling debris on public highways must have physical barriers (that is, covers and either tail gates or chain link fencing) to preclude debris from falling from the truck. Tailgates or chain link fencing must cover the full area at the rear of the dump body.

(a) Trucks must be equipped with back-up alarms.

(b) Use rollover warning devices for long-bed end dump (see para 18-8.b).

(c) Do not add sideboards to trucks to increase their capacity unless specific design specifications are provided to contractors as part of the scope of work or are provided by the manufacturer.

(d) Cut trees, to include leaners and hangers, into manageable size to allow placement in the bed of a truck. Secure all loads so that any debris, dust-like emission, aggregate (for example, gravel), soil, or stump cannot be ejected during transport to the final reduction site. After final reduction, use tarping systems that prevents workers from being exposed to fall hazards greater than 6 feet (1.8 m). Secure and tarp all loads leaving the reduction site.

(3) Prior to operation, contractors must develop written SOPs for each brush chipper, shredder, and grinder.

(a) SOPs must incorporate the manufacturer's recommendations for safe operation of the equipment as well as the use of a safety zone and fire prevention efforts.

(b) Keep a copy of the operations and maintenance manuals for chippers, grinders, and shredders onsite.

(c) A minimum 200 feet (61 m) safety zone is required for authorized persons during operation of chippers, shredders, and grinders unless documentation or actual practice indicates otherwise. Place signs every 200 feet (61 m) to identify the safety zone.

(d) Keep the public at least 300 feet (91.4 m) from all chipper operations.

(e) Do not permit unauthorized personnel to enter the safety zone while the chipper is in operation.

(f) Provide operators of front-end loaders, skid steers, knuckle booms, and other equipment working in debris reduction areas or feeding grinders, shredders, or chippers with protection according to chapter 18.

(g) Whenever chipper operations are shut down for any significant length of time (for example, overnight, or when the chipper will be left unattended), clear equipment walls, crevice drums, cutter heads and hammers, and drive mechanisms of all combustible materials by blowing, washing, and wetting down.

(h) Immediately remove any material contaminated by leakage of hydraulic fluids, oils, or fuel. Minimize leakage through preventive maintenance.

(i) Because piles of chipped wood are susceptible to spontaneous combustion, implement fire controls such as segregation, separation, and adequate water supply.

(4) Limit the number of workers in proximity to loaders, trucks, and other equipment to the minimum necessary to accomplish the job.

(a) In restricted areas or areas with reduced access or visibility, take special precautions to ensure the safety of workers on the ground.

(b) Sequence the work to minimize equipment movement when personnel are in the work area.

(c) Workers around operating machinery or vehicular traffic must wear high-visibility apparel according to chapter 5. These workers include, but are not limited to, flag persons, signalpersons, spotters, survey crews, and inspectors.

(5) Loaders, trackhoes, and other construction equipment in debris reduction areas must have functional lights in the front and back in order to work at night or during periods of reduced visibility.

(6) Select and use aerial lifts/platforms/bucket trucks according to chapter 22.

(7) Unless provided by the manufacturer, seat belts are not required at the operator's station on articulating grapple trucks (that is, knuckle boom trucks). If provided by the manufacturer, seat belts are required to be worn.

(8) Access ladders must be a minimum of 12 inches (30.5 cm) width with 16 inches (40.6 cm) recommended.

h. Traffic Control. (37-8.h)

(1) Traffic control is extremely important on highways, in residential areas, and at construction sites. When traffic may pose a hazard to operations, public roads must be closed. Coordinate road closings in writing with appropriate local agencies. Traffic controls and signage must comply with the MUTCD.

(2) When a road cannot be closed, take the following precautions:

(a) Place "FLAGGER", "WORKERS", or similar appropriate signs along the roadway, 1,000 feet (304.8 m) and 500 feet (152.4 m) before the work zone, on both sides of the work zone.

(b) Use a sufficient number of flag persons to control traffic within the work area.

(c) All flaggers must wear high-visibility apparel, safety-toed footwear, and hard hats according to chapter 5.

(d) Use "STOP/SLOW" paddles, preferably mounted on a 6 feet (1.8 m) staff, for traffic control.

(e) Flag persons must be able to communicate simultaneously with each other and with the foreman, and effectively signal and direct the affected public.

(f) Use two-way radios whenever visual contact between flaggers is not maintained.

(g) Flaggers must be trained according to paragraph 37-3.c prior to being placed in traffic.

(3) Keep fugitive dust emissions to a minimum within the work boundaries, especially when people are in/near debris towers.

i. Debris Reduction. (37-8.i)

(1) General Information.

(a) The contractor must notify the local fire department and arrange for fire suppression support in case of fire beyond the contractor's firefighting capability.

(b) Make readily available adequate supplies of water or fire extinguishers and use fire watches. Use a continuous fire watch at debris collection/reduction sites whenever there is reduction taking place or there is a visible flame. Use a fire watch when the site is not being actively worked and the potential exists for spontaneous combustion or other fire hazard. The fire watch must have at least one 20 lb. ABC fire extinguisher available and the means to expediently communicate with the site supervisor and designated fire response agencies. (See chapter 9)

(c) Do not co-mingle hazardous or containerized ignitable material with debris.

(d) Do not excavate pits to closer than 1 foot (0.3 m) of the ground water table. Line the pits with a compacted clay layer, or similar, to minimize migration of ash to the aquifer.

(e) Do not exceed particulate emissions of state and EPA standards for burning operations. The site manager must be continuously aware of wind conditions and adjust accordingly to control smoke encroachment into residential areas. Install wind meters onsite to track wind conditions. Personnel must work outside of direct smoke streams.

(f) Provide eye wash facilities at all burning and grinding operations (see chapter 6).

(g) For night operations, provide adequate lighting of 55 Lux (5 fc) in all outdoor work areas (see chapter 7).

(h) Post a Notice sign stating, "AUTHORIZED PERSONNEL ONLY" at entrances to debris collection/reduction areas. See graphics standard in EP 310-1-6a or ANSI Z535 series equivalent.

(i) Post a Danger sign stating, "Keep Back" at the edge of the 100 feet (30.5 m) setback from air curtain incinerators and open burn areas as a warning to personnel. See graphics standard in EP 310-1-6a or ANSI Z535 series equivalent.

(j) Clear a minimum 30 feet (9.1 m) wide fire lane around the full perimeter of the site and install a silt fence along the perimeter. Keep the fire lane clear of all combustible materials.

(k) Conduct all burning operations, including air-curtain incinerators, at a distance of no less than 1,000 feet (305 m) from an occupied dwelling or business, or a dwelling or business in such condition that it can be occupied.

(l) For outbuildings such as barns, sheds, structures destroyed by storms, tree lines and similar, the minimum separation distance is 300 feet (91.4 m), subject to local authority approval.

(m) Do not conduct burning operations within 100 feet (30.5 m) of overhead utility lines.

(2) Debris/Mulch Piles.

(a) Maintain at least 100 feet (30.5 m) between the debris/mulch piles and the burn area or incinerator.

(b) Maintain at least 1000 feet (305 m) between the debris/mulch piles and the nearest occupied dwelling or business or a dwelling or business in such condition that it can be occupied.

(c) Do not place debris/mulch piles directly under transmission lines nor locate them within 100 feet (30.5 m) of transmission towers.

(d) Clear a minimum 30 feet (9.1 m) wide fire lane around each debris/mulch pile. Keep the fire lane clear of all combustible materials.

(e) Do not stack mulch piles higher than 20 feet (6.1 m) high for more than seven consecutive days due to the increased risk of spontaneous combustion.

(3) Air-Curtain Incinerator Operations.

(a) Prior to operating an air-curtain incinerator, the contractor must develop a written AHA and SOP. Brief employees on the AHA and SOP and make it readily available for their review. In addition, the contractor must have all incinerator

placements inspected by a USACE SOH professional prior to the start of burning and ensure that the installed unit is maintained throughout the life of the activity.

(b) The design of air-curtain operations must provide for efficient burning of materials. If operating optimally, there should be minimal to no visible smoke plume above the pit.

(c) Equipment (for example, trackhoes) that feed burn pits/debris piles must have a fully enclosed cab equipped with an air filtration and pressurization system. Workers requiring respirators must be enrolled in the RPP and meet all applicable requirements according to chapter 5.

(d) Install a 1 foot (0.3 m) high warning barrier the length of the charging side of the pit to warn equipment operators. Construct it out of non-combustible material.

(e) Construct pits out of highly compactable material that will hold their shape.

(e-1) If a manufactured fire box is not provided, the incineration pits must be made of Type B soil (that is., cohesive soil), and be reinforced with earth anchors, wire mesh, or other items in order to support the weight of loaders.

(e-2) Check the edges of the pit for integrity on a regular basis to prevent unexpected cave-ins or collapse.

(e-3) Install an impervious layer of clay, or similar, on the bottom of the pit to seal the ash from the aquifer. Repair or replace the clay liner if scraped by dozers.

(e-4) The air-curtain pit must not extend more than 6 inches (15.2 cm) further at each end than the blower system.

(e-5) The ends of the pit must be near vertical and extend to the top of the pit.

(f) If a pick-and-drop debris pile is located within 100 feet (30.5 m) of the air curtain incinerator, the total volume of the pick-and-drop debris pile(s) supporting an incinerator must not be more than four times the volume of the incinerator pit.

(g) Place a 12-inch (30.5 cm) soil seal on the lip of the air curtain incineration pit to seal the blower nozzle. The nozzle must be 3 inches (7.6 cm) to 6 inches (15.2 cm) from the edge of the pit.

(4) Open Burning Operations.

(a) Open burning may involve one of the following:

(a-1) Ignition of brush piles in rows on top of the ground.

(a-2) Digging a fire pit in the ground or constructing the pit above ground using berms.

(a-3) Constructing a 3-sided bermed pit open at one end to allow equipment tending the fire to push the brush pile to one end and continue feeding. All brush is contained below the top of the bermed area.

(b) When open burning and sustained wind speeds reach 15 mph (24.1 km/h), do not add additional material to the burn pile.

(b-1) Full burning may resume when sustained wind speeds drop below 15 mph (24.1 km/h).

(b-2) When sustained wind speeds reach 20 mph (32.1 km/h), fires must be wetted or knocked down to control spread of fires.

(c) The areal extent of an open burning area must not exceed 200 feet by 200 feet (61 m by 61 m).

(c-1) If space permits the use of multiple open burning areas, maintain a 30 feet (9.1 m) fire lane between the open burning areas.

(c-2) The load approach area of the pits must be able to support the loading equipment without damaging the structural integrity of the pit walls.

(c-3) Construct a stop of non-combustible material no closer than 10 feet (3 m) of the edge of the pit to prevent equipment from falling into the pit.

(d) When burning in pits:

(d-1) AND the top of the brush pile remains below the top of the pit AND sustained winds reach 25 mph (40.2 km/h), do not add additional material to the pile.

(d-2) AND sustained wind speeds reach 30 mph (48.3 km/h), fires must be wetted or knocked down to control spread of fires.

(d-3) AND the brush pile extends above the top of the pit AND sustained wind speeds reach 15 mph (24.1 km/h), do not add more to the burn pile.

(d-4) AND the brush pile extends above the top of the pit AND sustained wind speeds reach 20 mph (32.2 km/h), all fires must be wetted or knocked down.

(d-4) Do not stack debris in the burning area higher than 10 feet (3 m) above the original ground level.

(5) Ash Management.

(a) Extinguish the burn approximately two hours before anticipated removal of the ash mound. Remove the ash mound before it reaches 2 feet (0.6 m) below the lip of the incineration pit.

(b) The contractor must exercise dust control measures while handling ash, especially during transport. Do not transport ash until it is proven fully extinguished (that is, soaked with water, producing no steam, having no visible evidence of residual hot embers).

j. Temporary Roofing. (37-8.j)

(1) During emergency operations that involve residential temporary roofing, RFO Commanders may permit:

(a) The use of athletic footwear by workers performing only temporary roofing operations.

(b) The removal of hard hats by workers on roof tops.

(2) Provide and use fall protection according to chapter 21 and figure 37-1.

(3) While workers are on the roof, monitor the weather.

k. Tower Safety Requirements. (37-8.k)

(1) An RPE must design all towers. Clearly mark them with weight capacities. Do not exceed the weight capacities under any circumstance. An option in place of wooden towers, is to use an engineered internal stairs scaffold designed by an RPE and that meets all manufacturer recommendations for safety concerns. Use of the engineered internal stairs scaffold still requires environmental protection. Contractors must comply with the design criteria included in the debris removal contracts.

(2) All towers must be ground-fault current interrupter protected, receptacles must have gasket weather-proof coverings, and both electrical boxes and conduit must be rated for outdoor use (see chapter 11).

(3) Do not make modifications to a tower that will affect its structural stability without first obtaining approval of the RPE.

(4) Personnel must not lean out of tower windows nor use stools or other steps to decrease the fall protection provided by the window height. If visibility of a load is obstructed, use a mirror or other tool.

(5) Tag all portable generators green after having been inspected and deemed in compliance with the manufacturer's recommendations, especially in regard to proper grounding.

(6) The KO or COR may approve the use of scissor lifts during the first 72 hours of the emergency operation while the tower is being constructed.

(a) No more than two workers may simultaneously occupy a scissor lift unless the manufacturer allows additional occupancy.

(b) Provide all personnel with and require them to wear proper fall protection with restraint lines while in the scissor lift (see chapter 21).

(c) Protect scissor lifts from impact by suitable impact protection equal to that required by a tower in the same location.

(7) Provide all towers with traffic barrier protection. The traffic barrier protection must consist of a minimum of eight precast concrete barriers measuring 10 feet long x 24 inches wide x 32 inches (3 m long x 61 cm wide x 81.3 cm wide) tall and must meet the ASTM C825 design specifications. Place three concrete barriers end to end parallel to the tower on each side. Place one concrete barrier on each end of the tower, with the concrete barrier nearest the stairs being offset 32 inches (81.3 cm) for pedestrian access to the tower.

l. Tree Maintenance (see chapter 31). (37-8.l)

m. Public Safety. Establish work area delineation, traffic control devices, and the use of flag persons according to ANSI/ASSP A10.34. Issue service announcements as needed to promote the safety of the public exposed to USACE activities. Install barriers and fencing to restrict the public from operation sites. Communicate with the public in a courteous manner. (37-8.m)

n. Health Hazard Recognition. (37-8.n)

(1) Identify and control health hazards (for example, asbestos, lead paint, radiation, hazardous chemicals) through the recommendations of an IH. Provide instrumentation, as required, for the detection and measurement of health hazards. After hazards have been identified, and measured, post this information at the work site, and keep copies of this posting by both the contractor and the relevant local USACE field office's Quality Assurance Team. Institute controls where required and include a description of the controls as part of the APP.

(2) Asbestos Recognition and Control. Before work begins where the potential exists for an exposure to asbestos containing material, develop an Asbestos Management Plan based on the age of the buildings, type of typical building materials

for the period and location, and any observations of debris or demolition areas. See chapter 6 for asbestos-related work requirements.

(a) An IH with asbestos training or an Asbestos Hazard Emergency Response Act trained supervisor or manager must write the plan.

(b) If possible, an asbestos inspector or an IH should inspect the anticipated work to identify and quantify asbestos hazards.

(c) The plan must address control mechanisms such as wetting with water or surfactant, worker and community protection, air sampling, and safe transport and disposal.

(d) As the asbestos volume and type may change, the pre-inspections of the debris and demolition areas must continue for each new sector.

o. Accident Reporting. (37-8.o)

(1) See chapters 1 or 2, as applicable.

(2) Report all contractor motor vehicle accidents and near misses occurring on public highways for trend analysis only.

p. Variances to Safety and Health Requirements. The onsite RFO SOH Manager may recommend variances to the requirements contained within this manual to the Geographic District SOHO. (37-8.p)

(1) The Geographic District SOHO must review the variance requests and concur or non-concur with each. Geographic District SOHOs must exercise prudent judgment in their recommendations for granting variances with due consideration of existing disaster conditions.

(2) After Geographic District SOHO concurrence, coordinate the recommended variance with the KO and COR for their concurrence and then give it to the RFO Commander for approval.

(3) The RFO Commander will approve or disapprove all requests for variance.

(4) Immediately provide a copy of all approved variances to Division and HQ SOHO for information only. The variances approved by the RFO Commander will expire at the end of the emergency operation mission.

37-9. Figures and Tables.

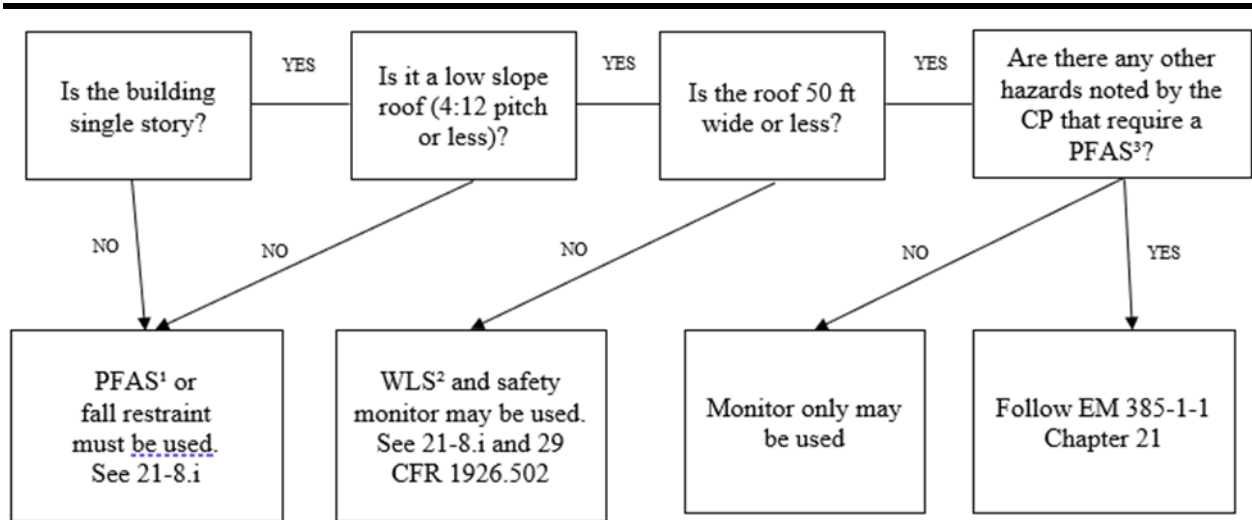

LEGEND

¹ Personal Fall Arrest System

² Warning Line System

³ Other hazards, for example, downed power lines or trees or obstruction from other sources, snow or ice, heavy rain or wind, roof load bearing risks, and insect/vermin hazards.

Figure 37-1. Blue-Roof Mission Fall Protection Chart

37-10. Checklists and Forms.

Not Applicable.